

Barbie®

Instructions

Dream House®

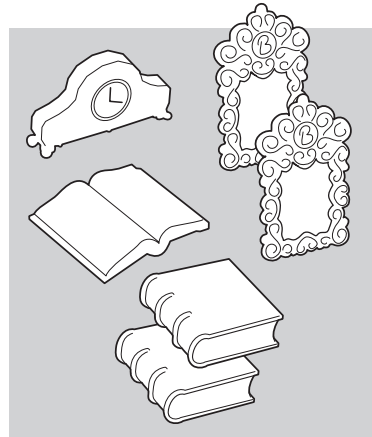
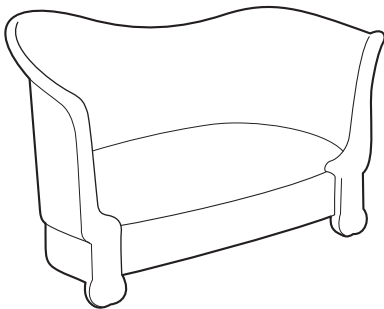
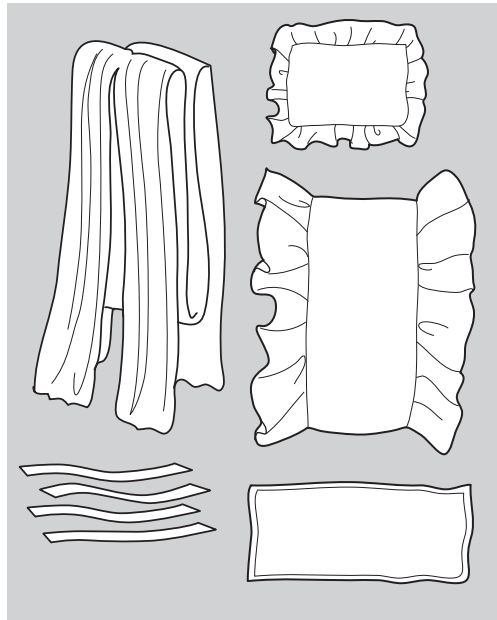

Colors and decorations may vary.

Please remove everything from the package and compare to the contents shown here.
If any items are missing, please call 1-800-524-TOYS.
Keep these instructions for future reference as they contain important information.

26445-0920



© 2000 Mattel, Inc., El Segundo, CA 90245 U.S.A. All Rights Reserved.

Unfold House

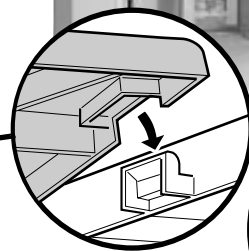
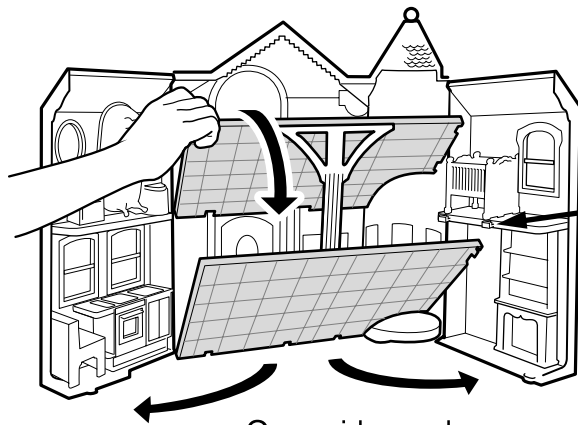
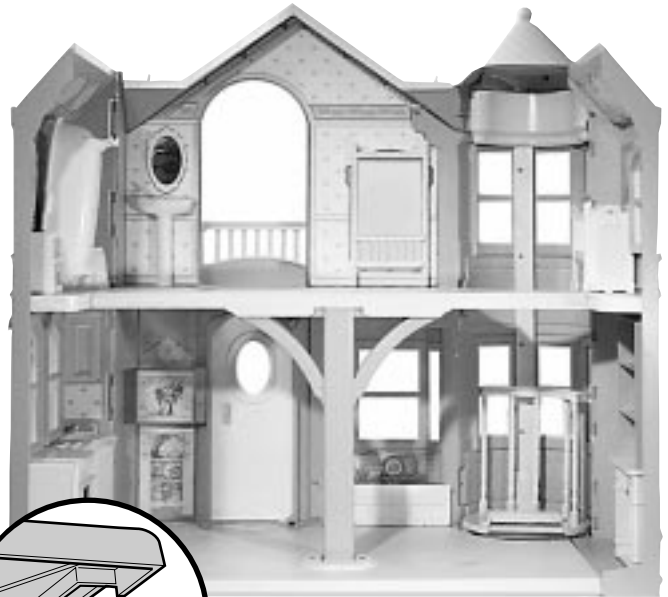
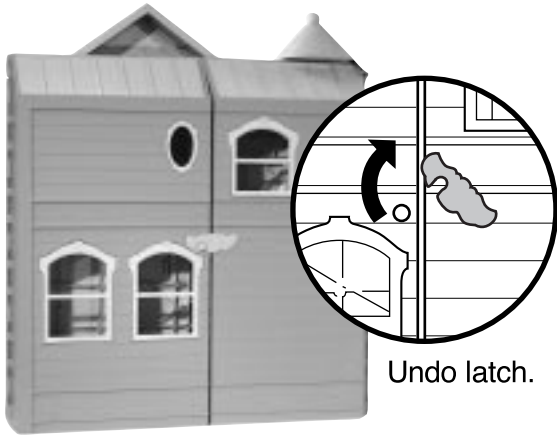

Snap floors into holders on sides.

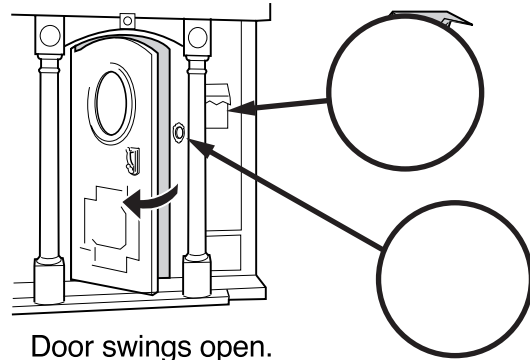
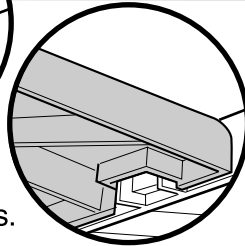

Welcome to the Dream House.™

Unfold Bed and Add Canopy

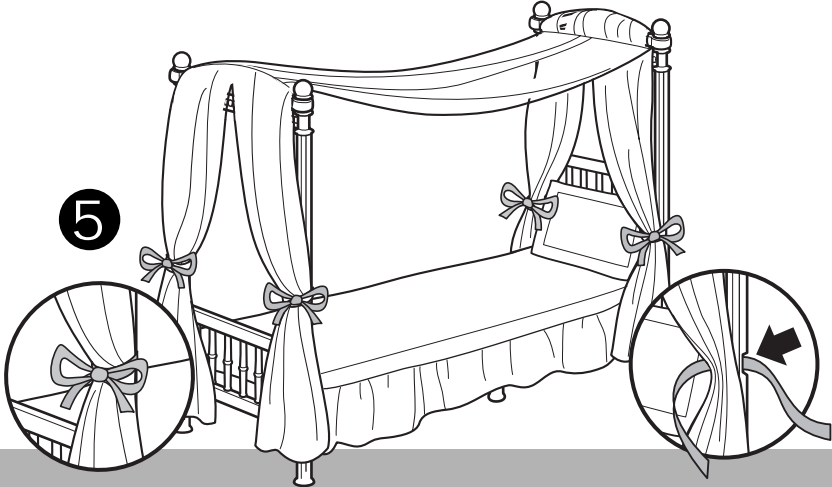
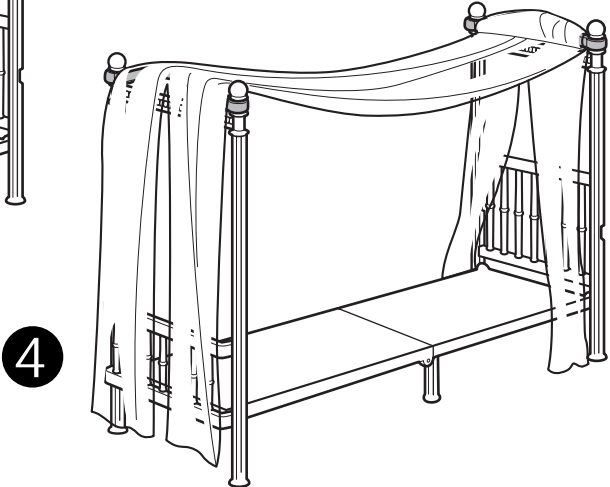
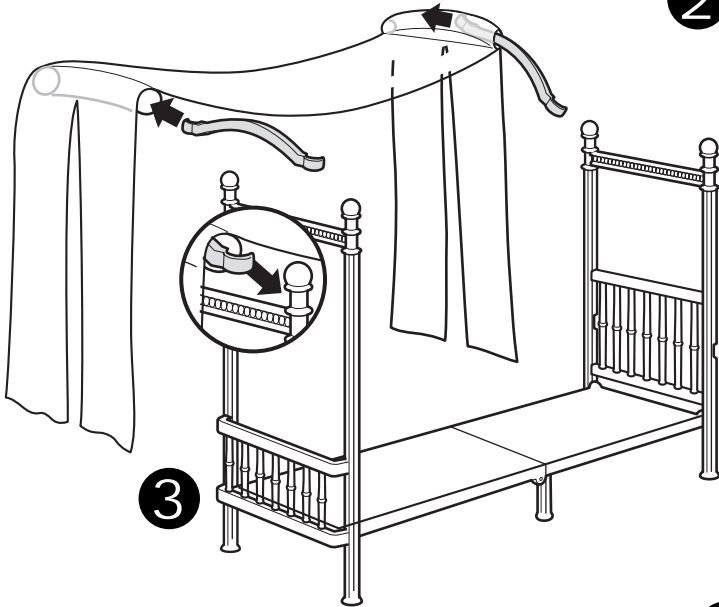
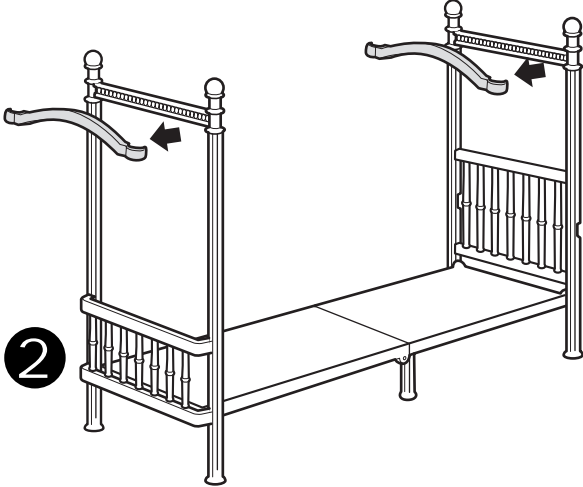
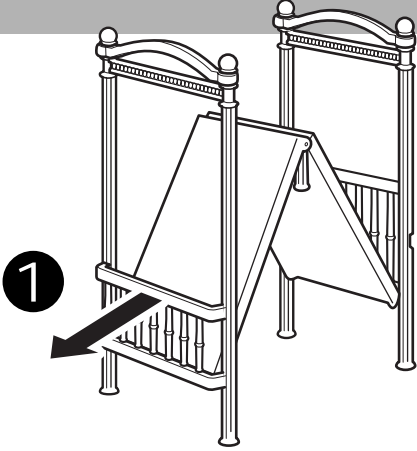

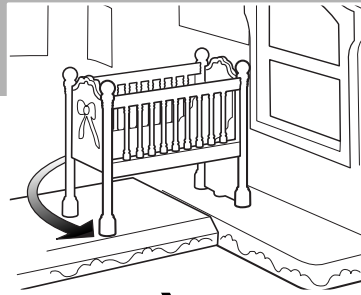

SEE "UNFOLD BED
AND ADD CANOPY"

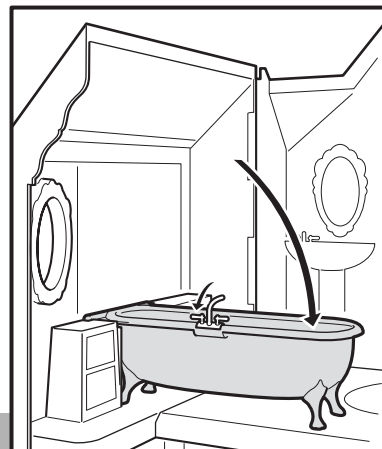
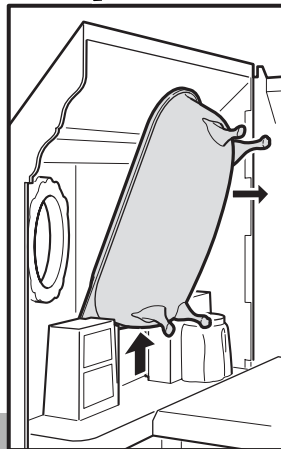
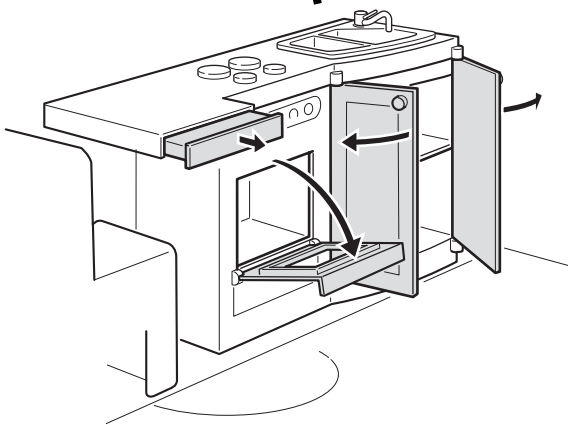
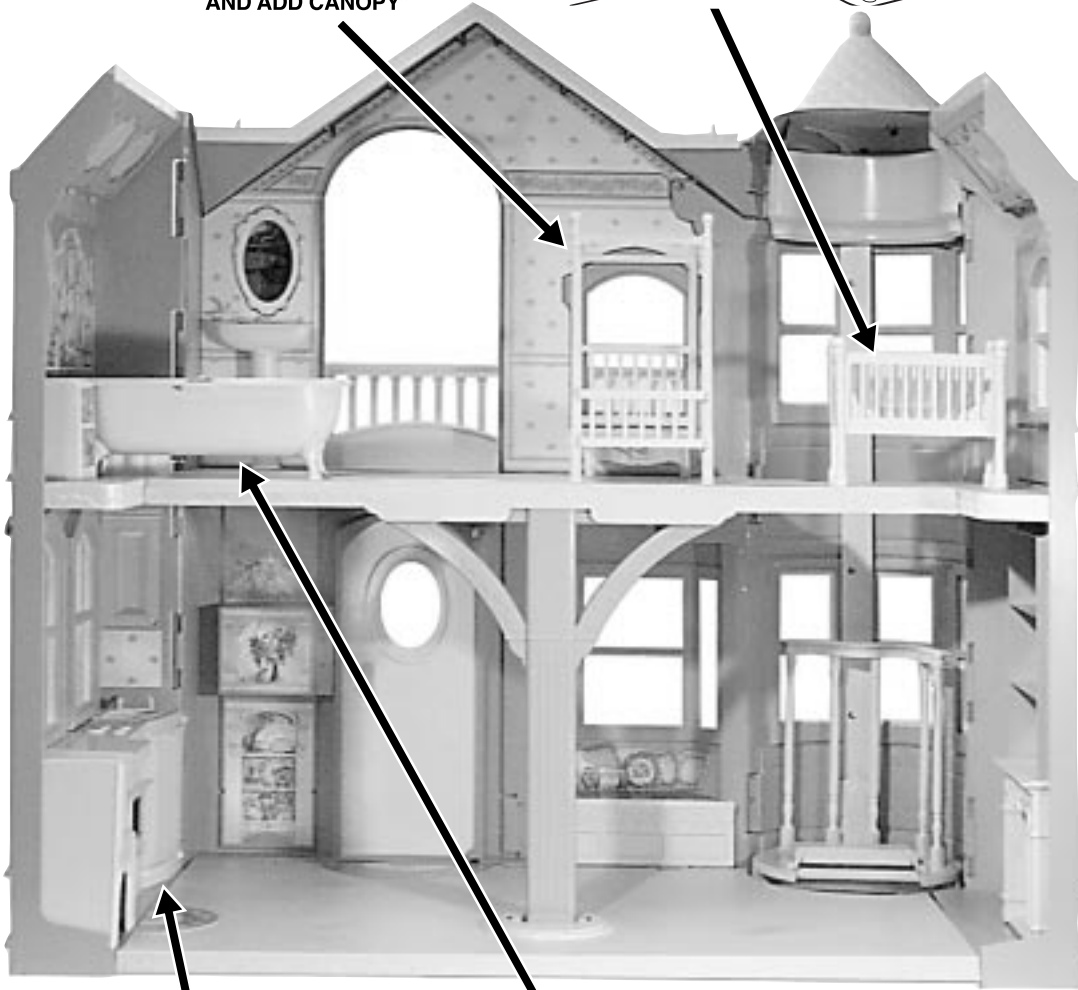

Raise and Lower Elevator

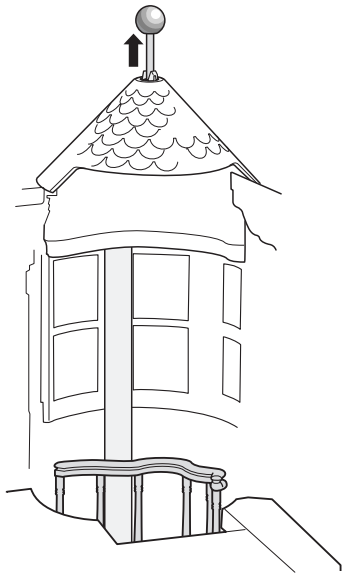

Raise handle.

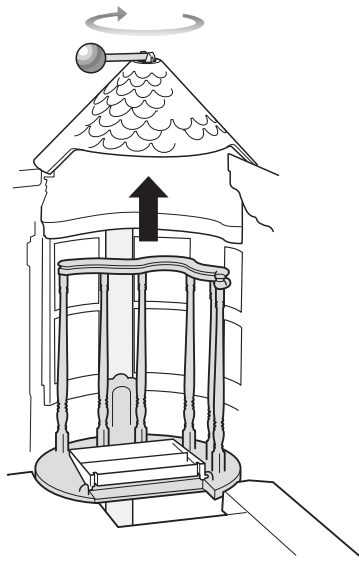

Turn handle to raise and lower elevator.

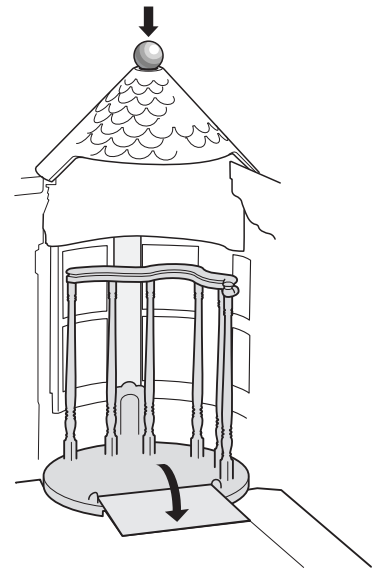

Swing ramp down and lower handle.

Storage

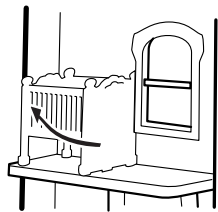

Swing crib back against wall.

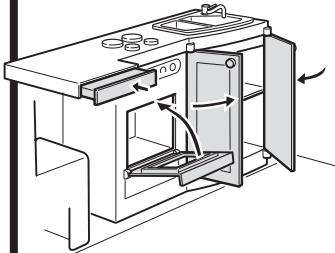

Shut kitchen doors.

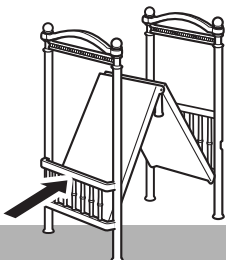

Fold up bed.

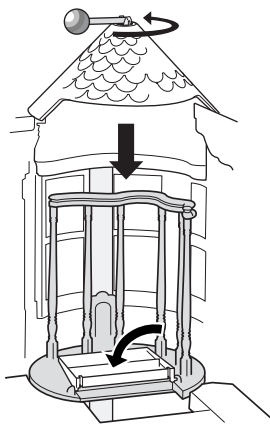

Close ramp, lower elevator and re-insert handle.

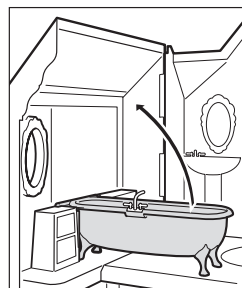

Fold tub up into wall.

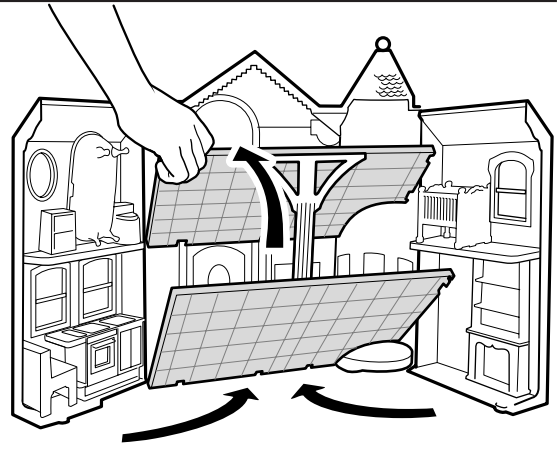

Fold up floors and sides.

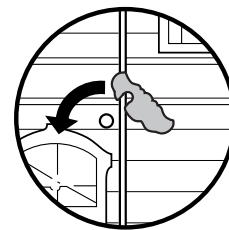

Close latch.

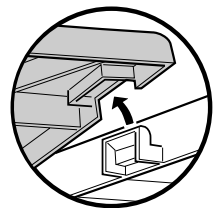

www.barbie.com

2 YEAR LIMITED WARRANTY

Mattel, Inc. warrants to the original consumer purchaser that this product will be free of defects in material or workmanship for two years (unless specified in alternate warranties) from the date of purchase. If defective, return the product along with proof of the date of purchase, postage prepaid, to Consumer Adjustment Center, 15930 E. Valley Boulevard, City of Industry, California 91744 for replacement or refund at our option. This warranty does not cover damage resulting from unauthorized modification, accident, misuse, or abuse. **Valid only in U.S.A.** This warranty gives you specific legal rights and you may also have other rights which vary from state to state.

Send only the product to the address above. Send all correspondence to Consumer Relations, Mattel, Inc., 333 Continental Blvd., El Segundo, California 90245-5012, U.S.A. Or you may phone us toll-free at 1-800-524-TOYS, Monday - Friday, 8:00 a.m. - 6:00 p.m. Eastern Time. See telephone directory for Mattel listing.



CONSUMER INFORMATION	
	<p>YOU CAN TELL IT'S MATTEL™! CALL us toll-free or write with any comments or questions about our products or service. Monday-Friday 8:00 a.m. - 6:00 p.m. Eastern Time. Outside U.S.A., see telephone directory for Mattel listing.</p> <p>Consumer Relations, Mattel, Inc. 333 Continental Blvd. El Segundo, CA 90245 USA</p> <p>1(800)524-TOYS</p>
WE ARE DEDICATED TO QUALITY PRODUCTS.	