

Play Time! (continued)

Reward doll with a sticker for using the potty!

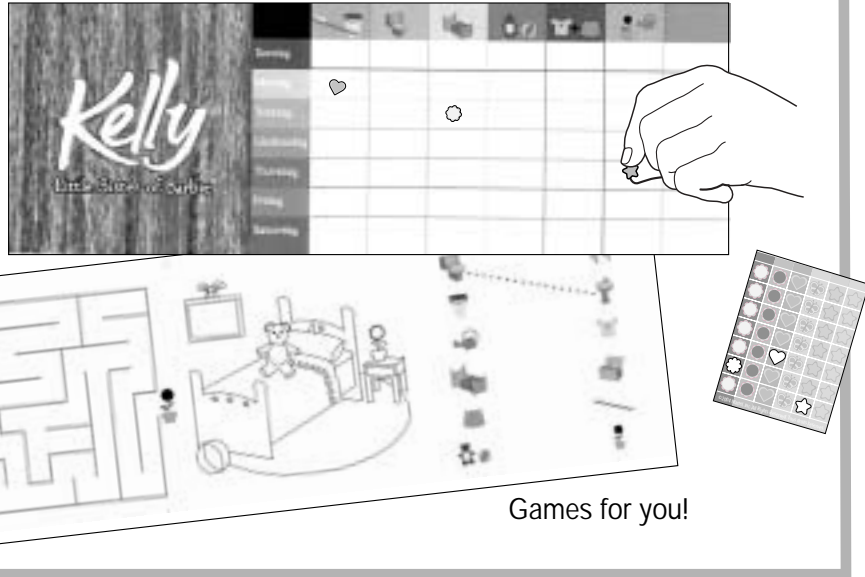

Kelly[®] Doll

INSTRUCTIONS



(1X) Pictured above.

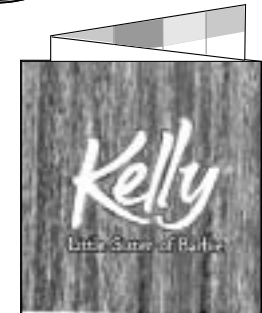
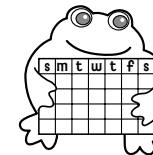
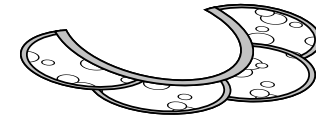
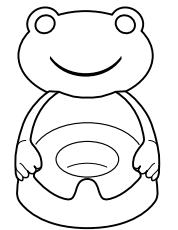
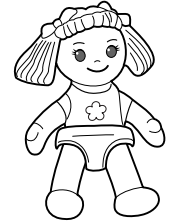

CONTENTS

Colors and decorations may vary from those shown.

WARNING:
CHOKING HAZARD - Small parts.
Not for children under 3 years.

Please remove everything from the package and compare to the contents shown here.
If any items are missing, please call 1-800-524-TOYS.

3+



G8042-0920

Keep these instructions for future reference as they contain important information.

©2004 Mattel, Inc., El Segundo, CA 90245 U.S.A. All Rights Reserved.

Clean & Store

Surface washable only.

After each use, place the doll on the potty to drain the water, then rinse, clean, and dry all items.



CONSUMER INFORMATION

YOU CAN TELL IT'S MATTEL!™ CALL us toll-free or write with any comments or questions about our products or service. Monday-Friday 8:00 a.m.-6:00 p.m. Eastern Time. Outside U.S.A., see telephone directory for Mattel listing.

Consumer Relations, Mattel, Inc.
333 Continental Blvd.
El Segundo, CA 90245 USA

1 (800) 524-TOYS

WE ARE DEDICATED TO QUALITY PRODUCTS.

Mattel U.K., Ltd., Vanwall Business Park, Maidenhead SL6 4UB. Helpline 01628500303.

Mattel Australia Pty., Ltd., Richmond, Victoria 3121. Consumer Advisory Service 1300 135 312 (valid only in Australia).

Mattel East Asia Ltd, Room 1106, South Tower, World Finance Centre, Harbour City, Tsimshatsui, HK, China.

Dilimport & Diedarkan Oleh: Mattel SEA Ptd Ltd.(993532-P) Lot 13.5, Menara Lien Hoe, Persiaran Tropicana Golf Country Resort, 47410



Play Time!

Water toys sometimes get messy, so please protect play surfaces before use. Drain/rinse/clean/dry all items thoroughly before storing.

FUN TIP! Package is a pop-up play scene!
(Just carefully remove inside of package.)

- 1** Fill bottle with clean tap water:
A. Squeeze air out.
B. Hold sipping cup under water, then relax your squeeze to let water in. (*Sipping cup will not fill completely.*)

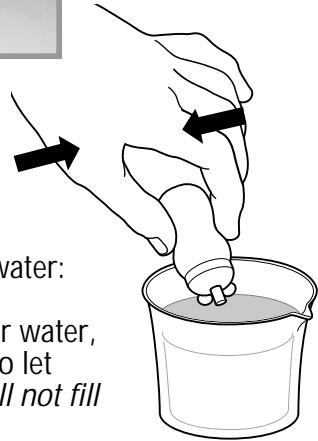

Cup or pail is not included.

- 3** Remove your doll's panties. Put your doll on her potty! Squeeze her tummy and she really tinkles!

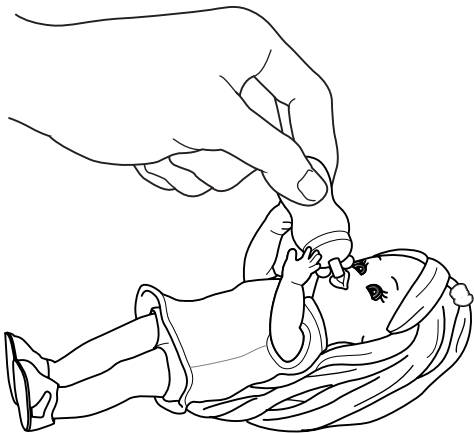
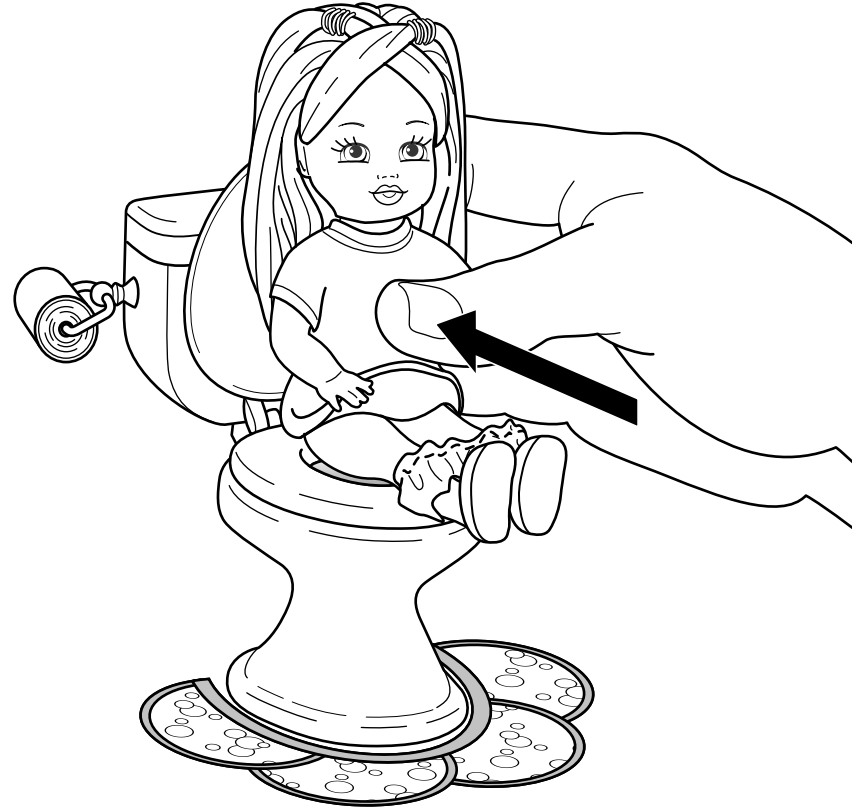

- 2** Lay your doll on her back.* Insert tip of sipping cup all the way into doll's mouth.

**Your doll could have an "accident" if fed sitting upright or if you feed her too much.*

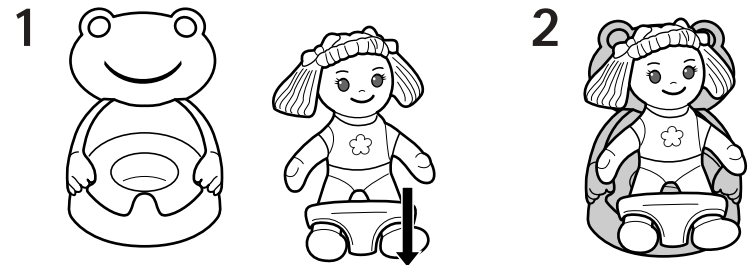

Play Time! (continued)

Reward doll with a sticker!

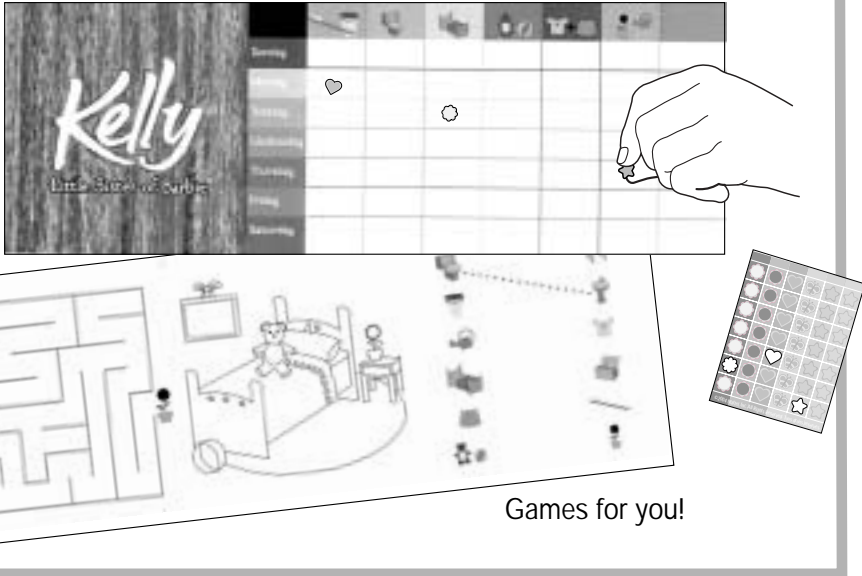

Games for you!

Storage

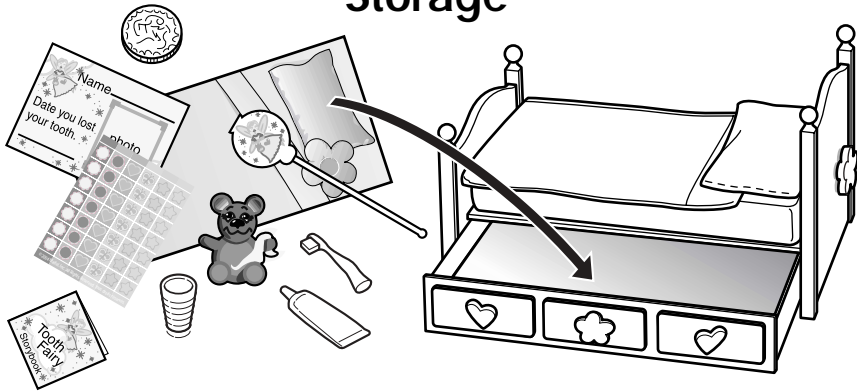

Kelly[®] Doll

INSTRUCTIONS

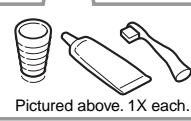
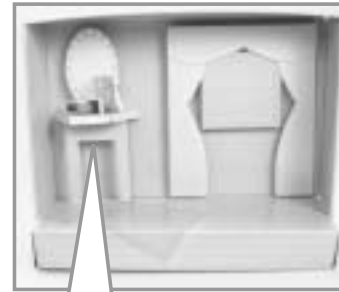

Pictured above. 1X each.

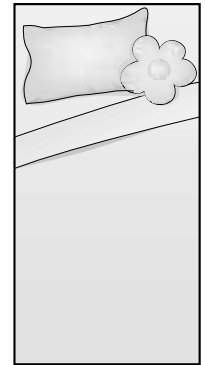
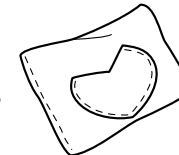
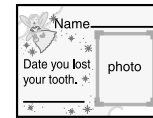
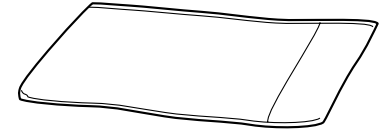
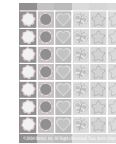
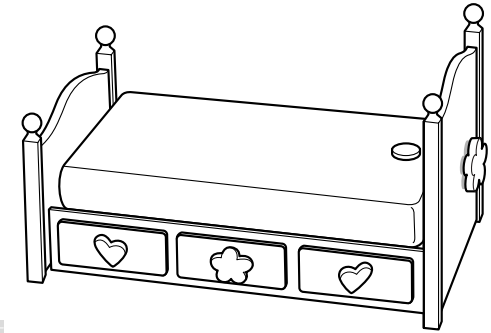

CONTENTS

CONSUMER INFORMATION

YOU CAN TELL IT'S MATTEL!™ CALL us toll-free or write with any comments or questions about our products or service. Monday-Friday 8:00 a.m.-6:00 p.m. Eastern Time. Outside U.S.A., see telephone directory for Mattel listing.

Consumer Relations, Mattel, Inc.
333 Continental Blvd.
El Segundo, CA 90245 USA

1(800) 524-TOYS

WE ARE DEDICATED TO QUALITY PRODUCTS.

Mattel U.K., Ltd., Vanwall Business Park, Maidenhead SL6 4UB. Helpline 01628500303.

Mattel Australia Pty., Ltd., Richmond, Victoria 3121. Consumer Advisory Service 1300 135 312 (valid only in Australia).

Mattel East Asia Ltd, Room 1106, South Tower, World Finance Centre, Harbour City, Tsimshatsui, HK, China.

Diimport & Diedarkan Oleh: Mattel SEA Ptd Ltd.(993532-P) Lot 13.5, Menara Lien Hoe, Persiaran Tropicana Golf Country Resort, 47410

WARNING:
CHOKING HAZARD - Small parts.
Not for children under 3 years.

Colors and decorations may vary from those shown.

Please remove everything from the package and compare to the contents shown here. If any items are missing, please call 1-800-524-TOYS.

3+



G8373-0920

Keep these instructions for future reference as they contain important information.



Play Time!

Water toys sometimes get messy, so please protect play surfaces before use. Drain/rinse/clean/dry all items thoroughly before storing.

FUN TIP! Package is a pop-up play scene!
(Just carefully remove inside of package.)

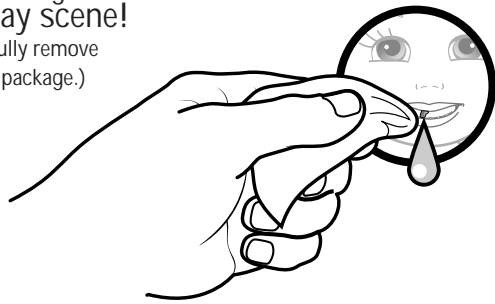

1 Before play, apply water with cloth (not included) to remove the water-soluble paint from the "tooth".

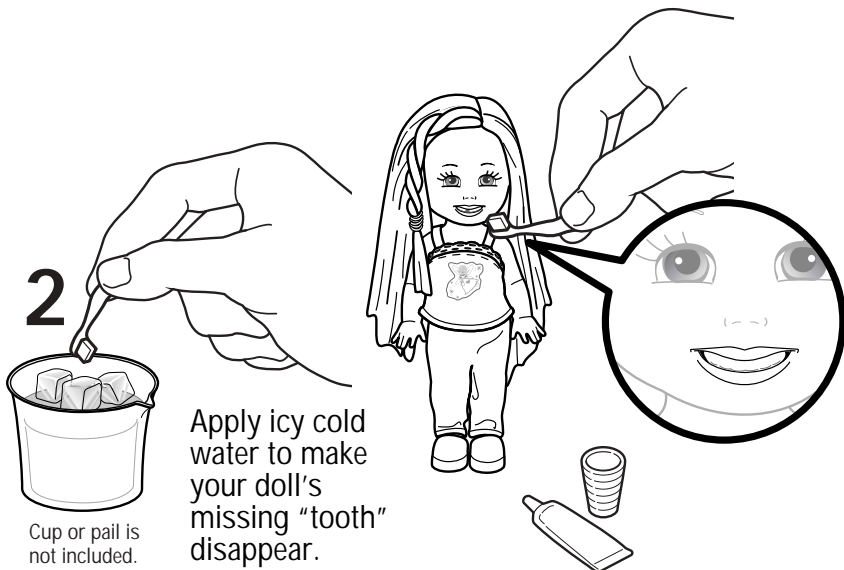

2 Apply icy cold water to make your doll's missing "tooth" disappear.
Cup or pail is not included.

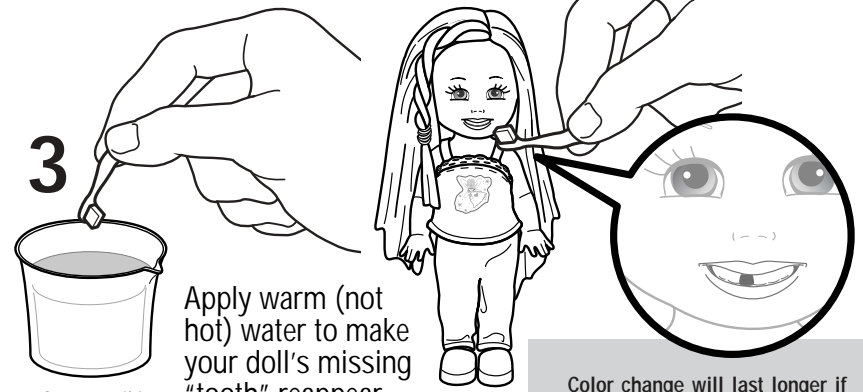

3 Apply warm (not hot) water to make your doll's missing "tooth" reappear.

Cup or pail is not included.

To avoid burns, do not use water that is too hot, above 120 degrees F (°C).

Color change will last longer if not exposed to intense heat or direct sunlight for prolonged periods of time.

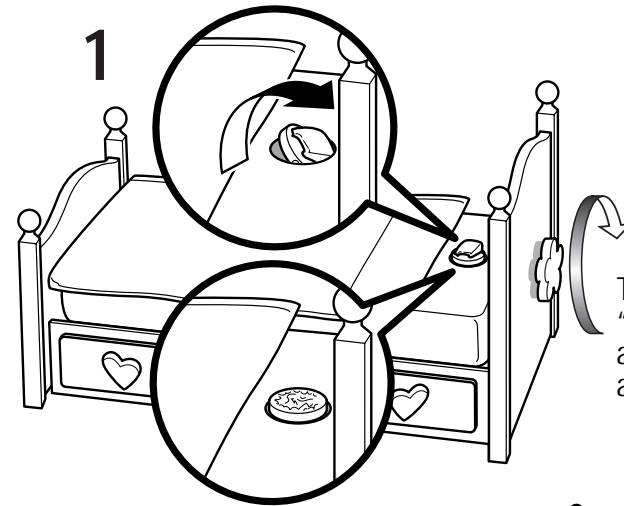

Turn knob. "Tooth" vanishes and a "coin" appears.

2 Put your own tooth in the "magic" pillow at bed time.

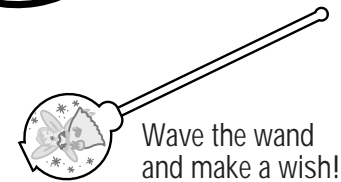

Wave the wand and make a wish!

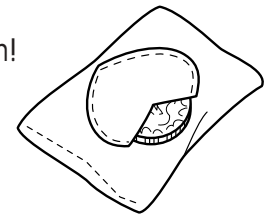
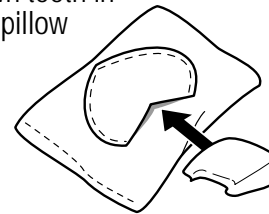

When you awaken, check the pillow to see what the tooth fairy left!