

MEGA
Barbie
BUILDING SETS



**WONDER
BUILDERS™**

GYH09

**ANIMAL GROOMING STATION
SALON DE TOILETTAGE**

ESTACIÓN DE CUIDADO PARA ANIMALITOS

ESTAÇÃO DE CUIDADOS PARA OS ANIMAIZINHOS

TIERPFLEGESTATION • САЛОН ДЛЯ УХОДА ЗА ЖИВОТНЫМИ



PLAY AS YOU BUILD! JUEZ EN CONSTRUIR!

JUEGA MIENTRAS CONSTRUYES • CONSTRUÇÃO E BRINCADEIRA SIMULTÂNEAS
GLEICHZEITIG BAUEN UND SPIELEN • СТРОИ И ИГРАЙ



CHOOSE WHAT YOU WANT TO BUILD FIRST! CHOISISSEZ CE QUE VOUS VOULEZ CONSTRUIRE EN PREMIER!

¡ELIGE QUÉ QUIERES CONSTRUIR PRIMERO!
ESCOLHA O QUE VOCÊ QUER CONSTRUIR PRIMEIRO!
KINDER KÖNNEN AUSSUCHEN, WAS SIE ZUERST BAUEN WOLLEN!
ВЫБЕРИ, ЧТО ТЫ ХОЧЕШЬ СОБРАТЬ СНАЧАЛА!

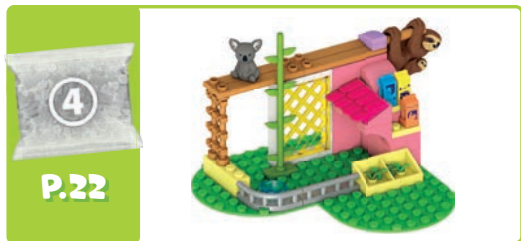

MEGA
UNBOXED



TRY OUR INTERACTIVE
BUILDING INSTRUCTIONS!

CONSULTEZ NOS INSTRUCTIONS DE
CONSTRUCTION INTERACTIVES!

¡CONSULTA NUESTRAS INSTRUCCIONES
DE CONSTRUCCIÓN INTERACTIVAS!
CONSULTE NOSSAS INSTRUÇÕES
DE CONSTRUÇÕES INTERATIVAS!
MIT INTERAKTIVEN BAUANLEITUNGEN!
ОЗНАКОМЬСЯ С НАШИМИ ИНТЕРАКТИВНЫМИ
ИНСТРУКЦИЯМИ ПО СБОРКЕ!



UNBOXED.MEGAONSTRUX.COM

CUSTOMIZE YOUR BARBIE FIGURE! PERSONNALISEZ VOTRE FIGURINE BARBIE!

PERSONALIZA TU BARBIE! - PERSONALIZE SUA BARBIE!
DIE BARBIE-FIGUREN INDIVIDUELL GESTALTEN!
СДЕЛАЙ СВОЮ ФИГУРКУ БАРБИ УНИКАЛЬНОЙ!



1



2

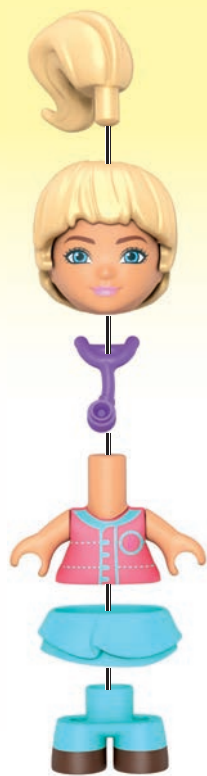

1



2



1



2

LET'S BUILD THE BATHING STATION! CONSTRUYAMOS LA PISCINE!

¡CONSTRUYAMOS UNA ESTACIÓN DE BAÑO!
CONSTRUAMOS UMA ESTAÇÃO DE BANHO!
EINE BADESTATION BAUEN!
ДАВАЙ СОБЕРЕМ СТАНЦИЮ ДЛЯ КУПАНИЯ!

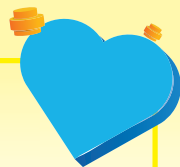

1



2

1

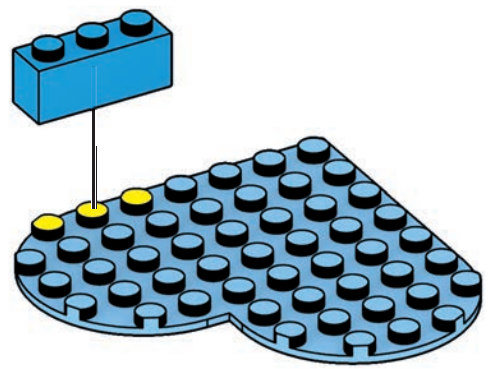
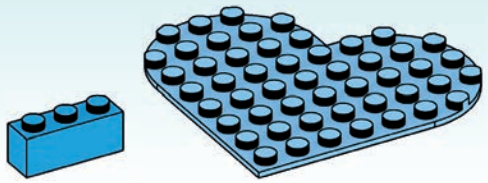

2

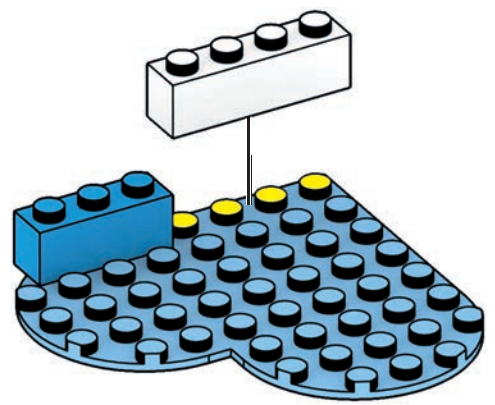
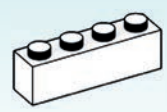

3

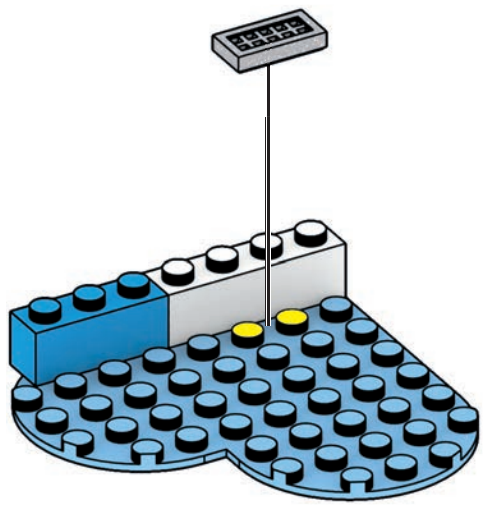

4

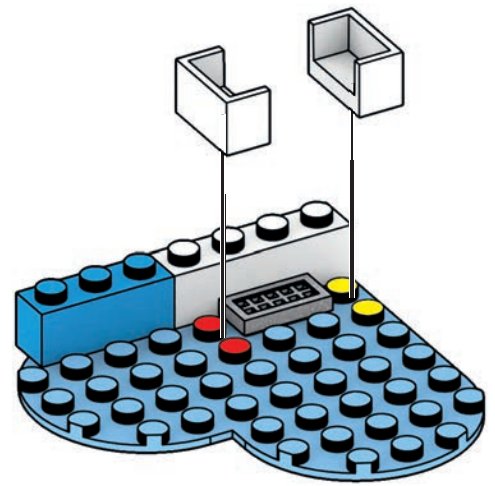
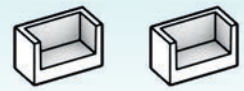

5

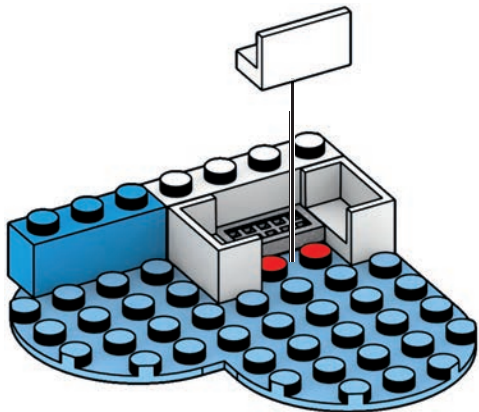

6

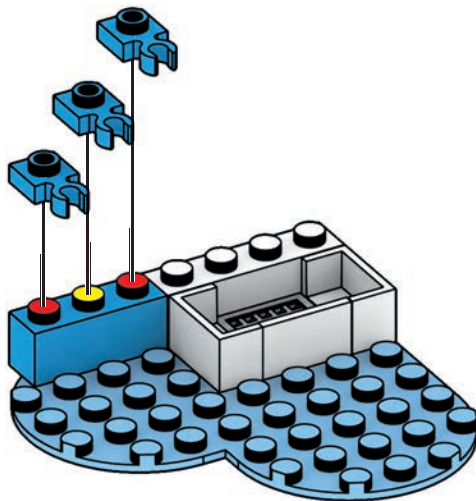

7

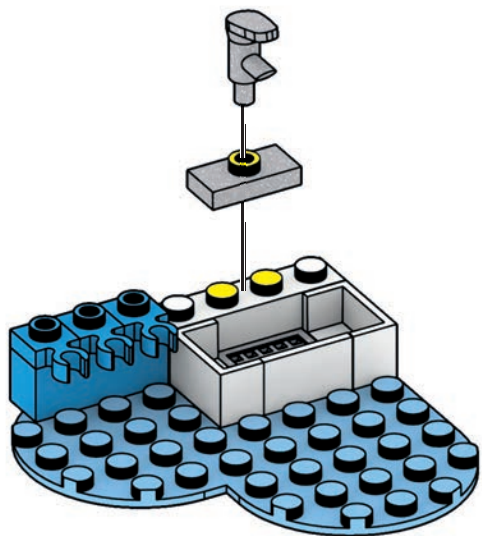
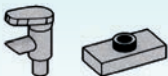

8

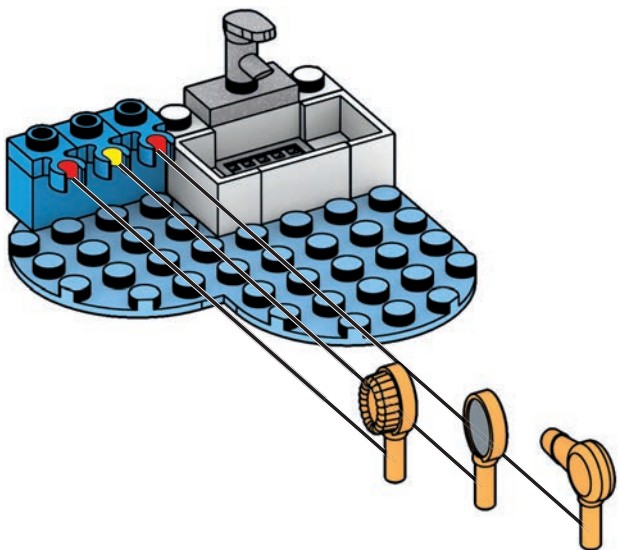

9

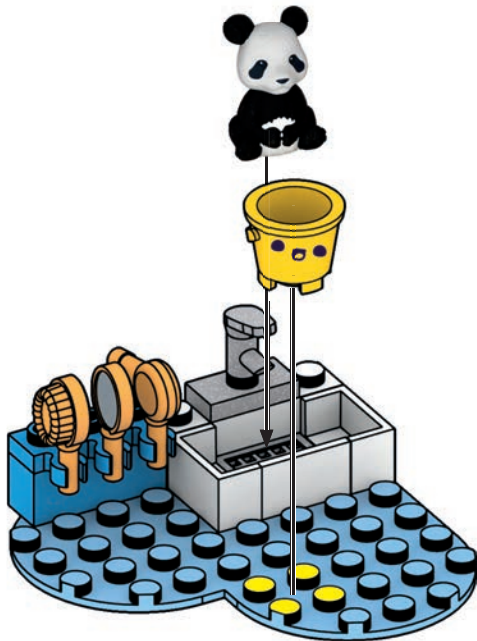

1



2



LET'S BUILD THE VET STATION! CONSTRUIVONS LA ZONE DE SOIN DES ANIMAUX!

¡CONSTRUYAMOS UNA VETERINARIA!
CONSTRUAMOS UM VETERINÁRIO!
EINE TIERARZTPRAXIS BAUEN!
ДАВАЙ СОБЕРЕМ СТАНЦИЮ ВЕТЕРИНАРА!



CUSTOMIZE YOUR BARBIE FIGURE! PERSONNALISEZ VOTRE FIGURINE BARBIE!

¡PERSONALIZA TU BARBIE! • PERSONALIZE SUA BARBIE!
DIE BARBIE-FIGUREN INDIVIDUELL GESTALTEN!
СДЕЛАЙ СВОЮ ФИГУРКУ БАРБИ УНИКАЛЬНОЙ!



10

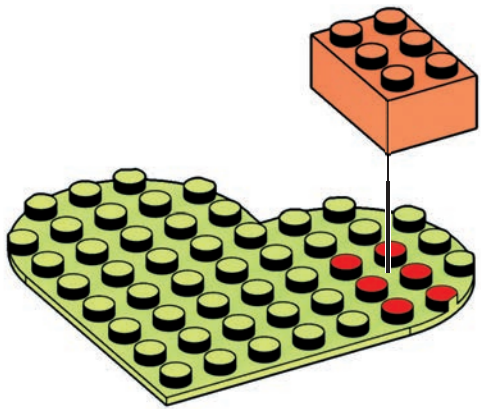
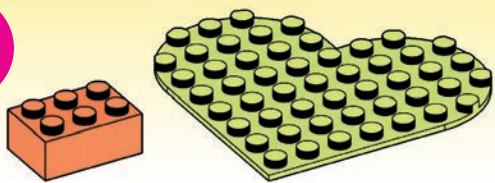

11

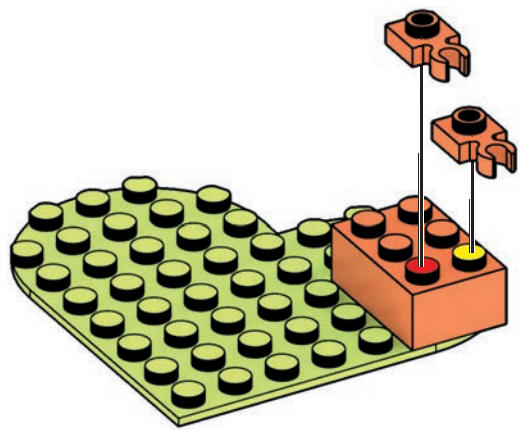

12

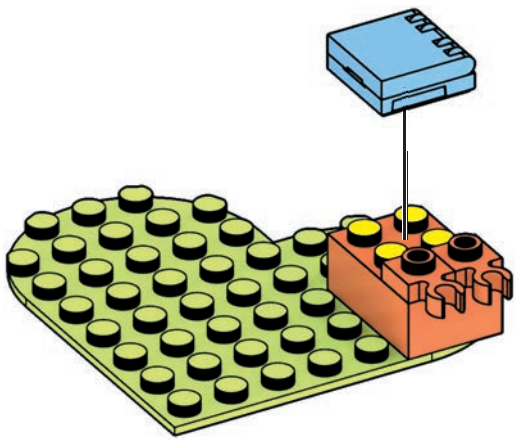

1

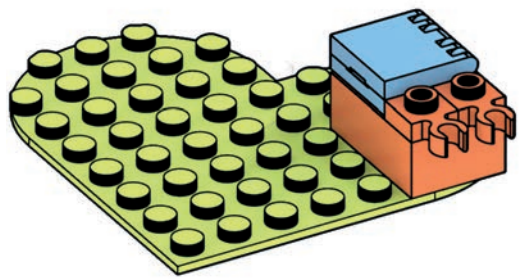

2

13

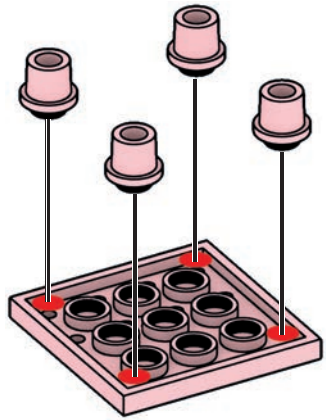
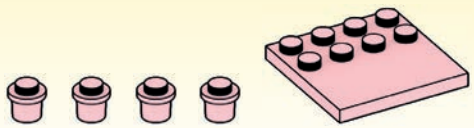

1

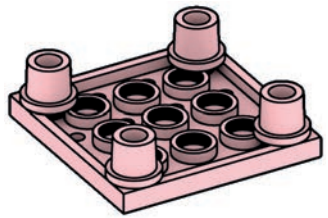

2

14

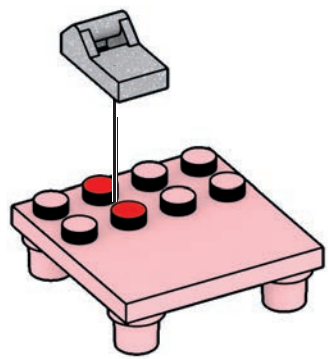

15

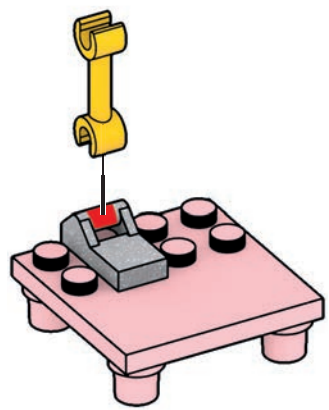

16

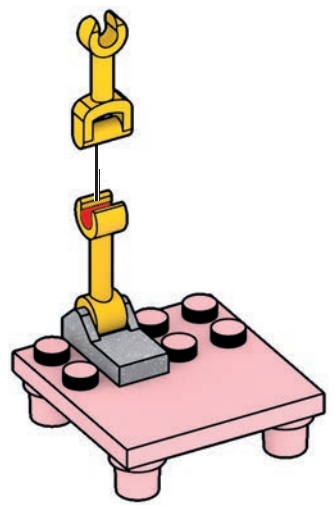

1

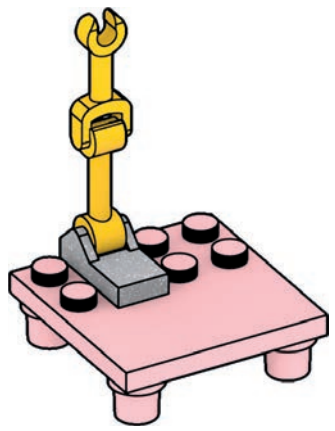

2

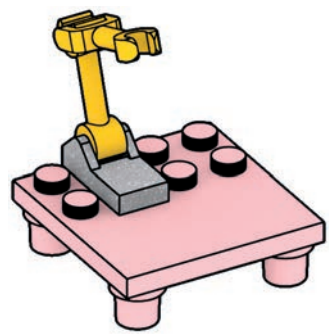

3

17



1



2

18

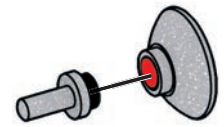

1



2

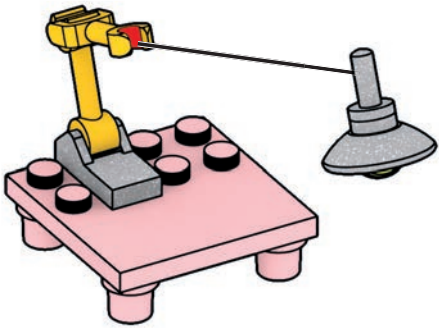

1

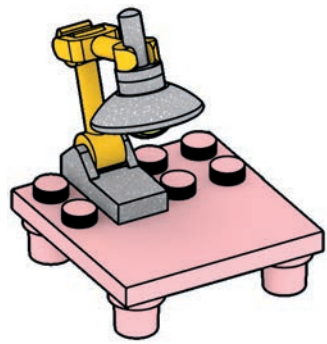

2

20

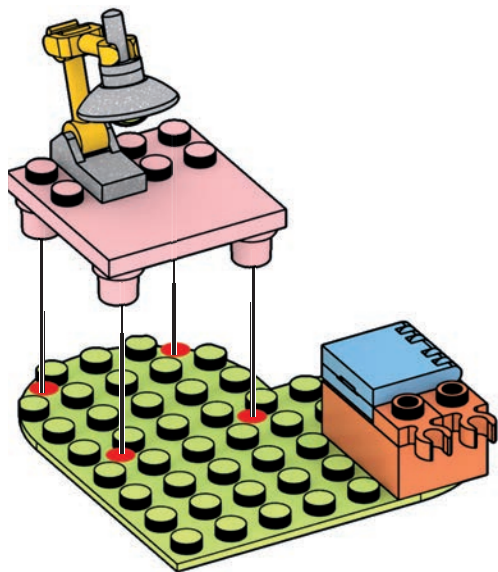

21

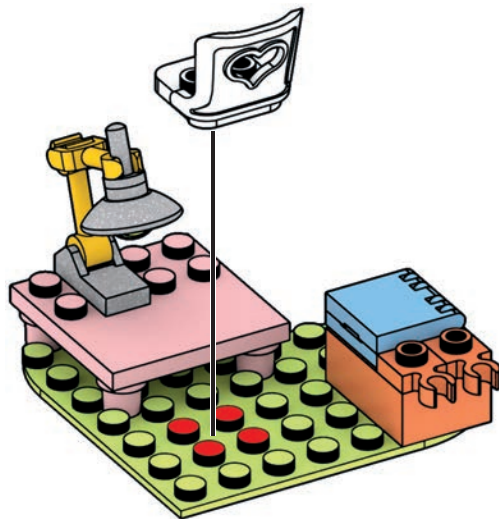

22

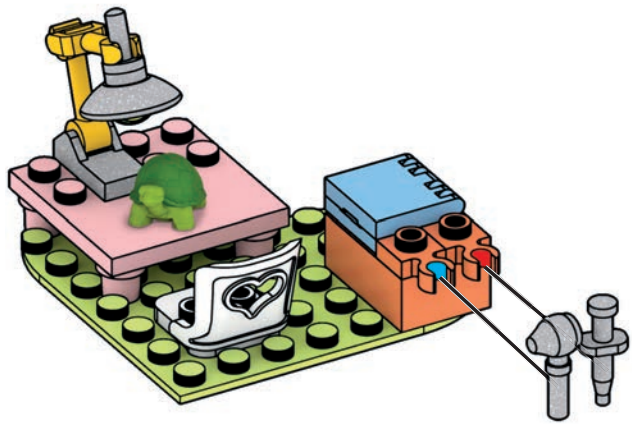

1

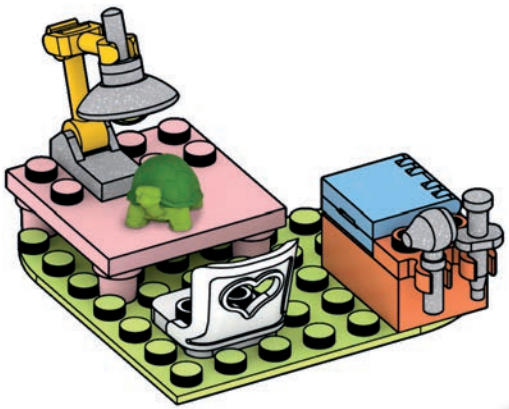

2

LET'S BUILD THE FEEDING STATION! CONSTRUIVONS LA ZONE D'ALIMENTATION !

¡CONSTRUYAMOS UNA ESTACIÓN DE COMIDA!
CONSTRUAMOS UMA ESTAÇÃO DE COMIDA!
EINE FUTTERSTATION BAUEN!
ДАВАЙ СОБЕРЕМ СТАНЦИЮ ДЛЯ КОРМЛЕНИЯ!

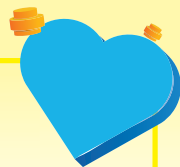

1



2

23

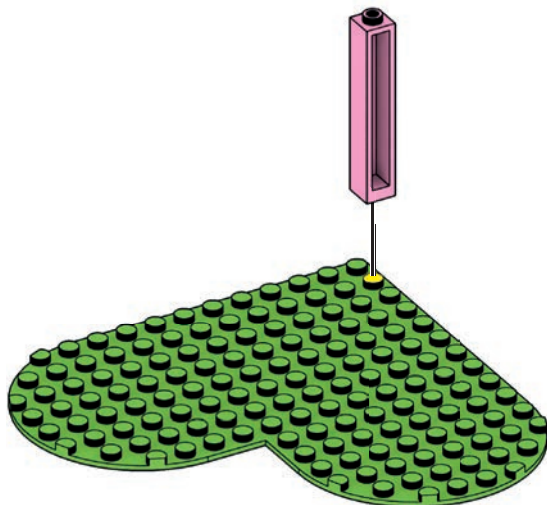
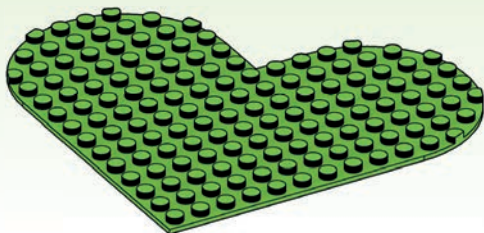

24

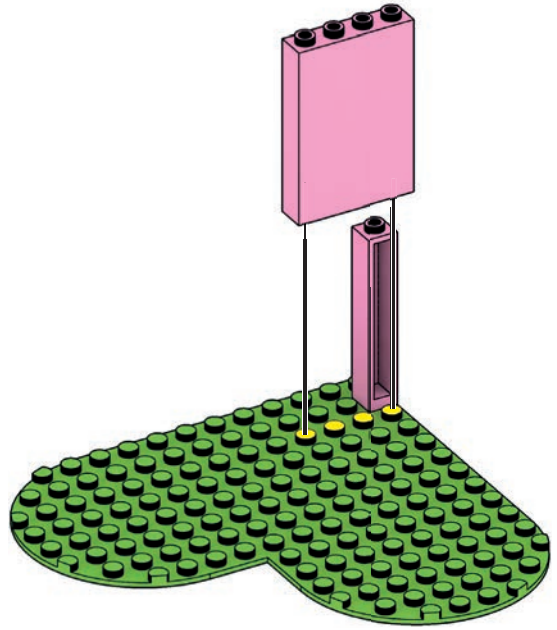
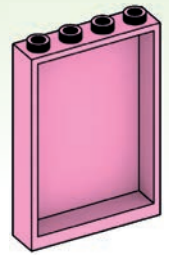

25

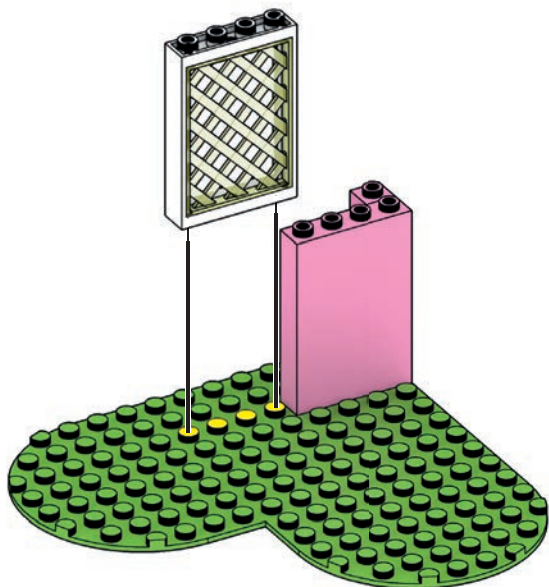
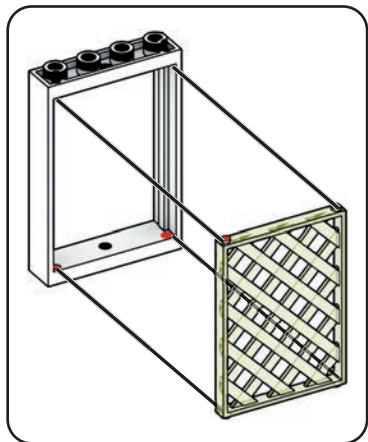
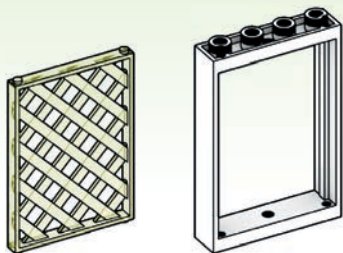

26

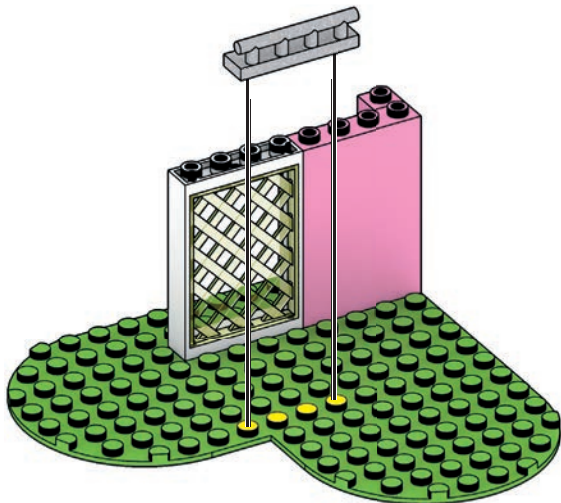
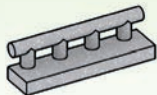

27

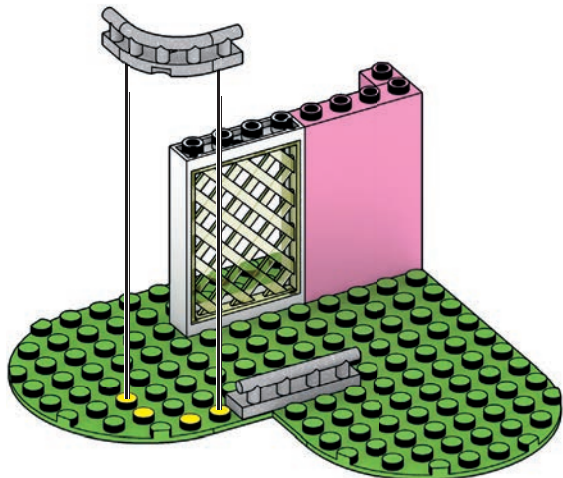
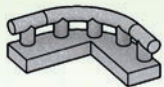

28

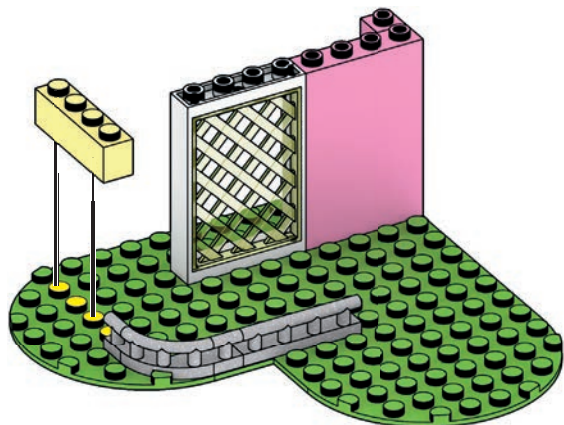
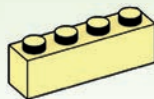

29

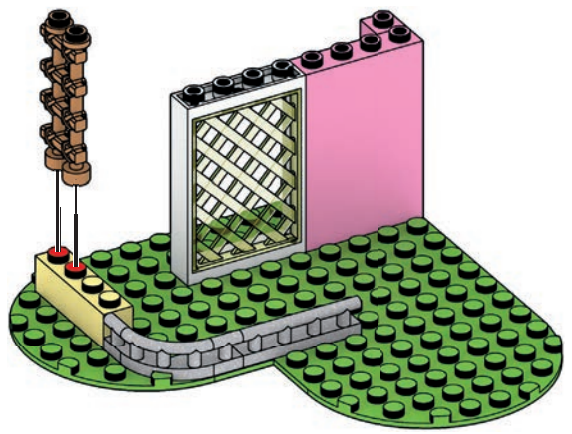

30

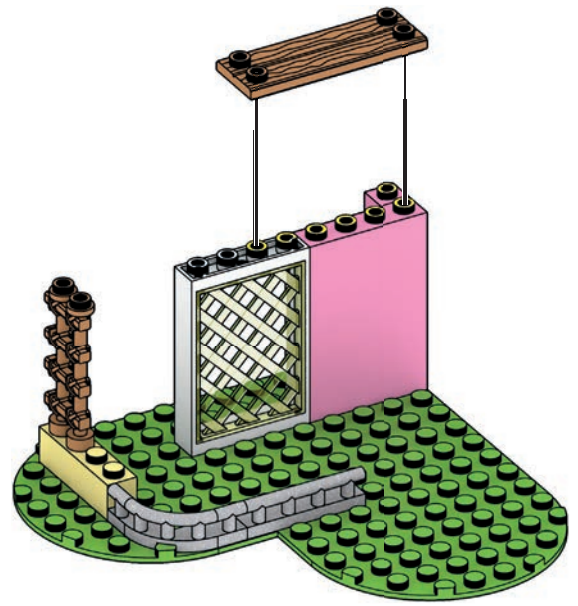

31

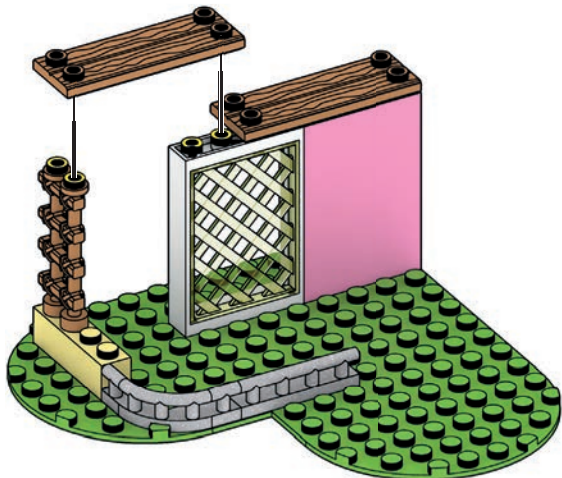

32

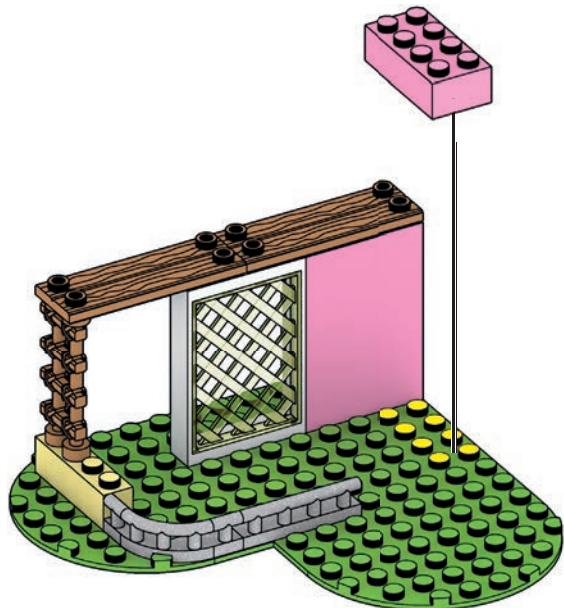
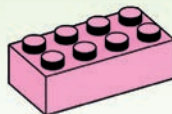

33

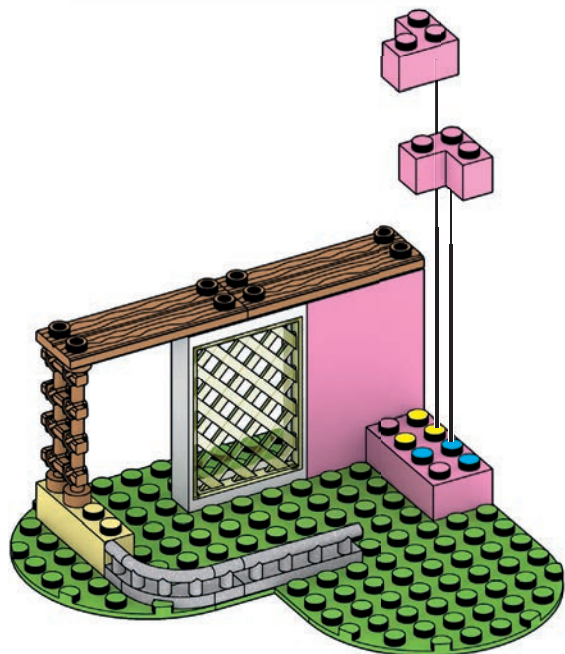
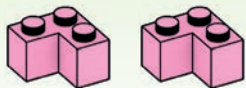

34

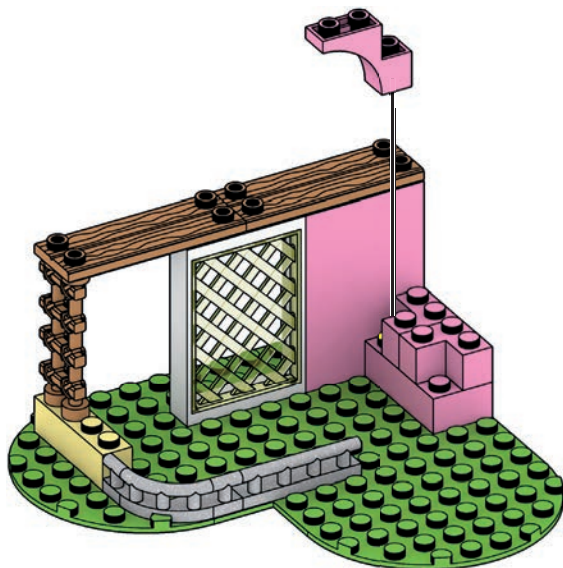

35

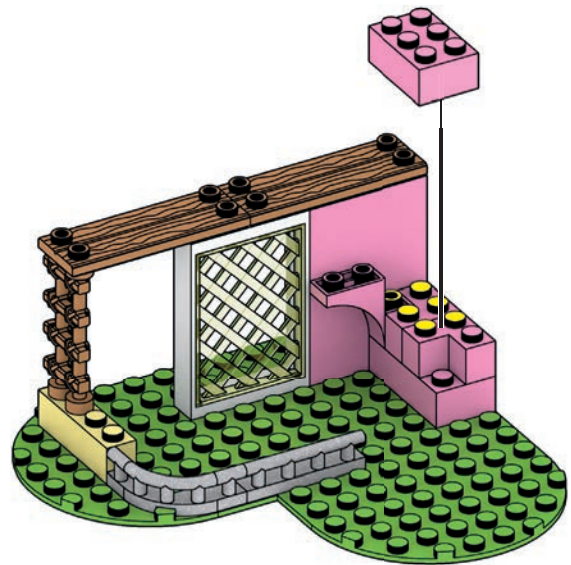
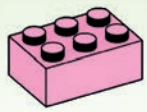

36

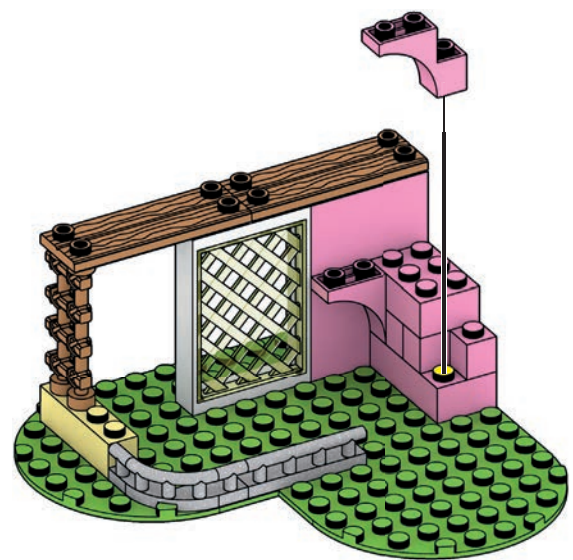
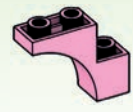

37

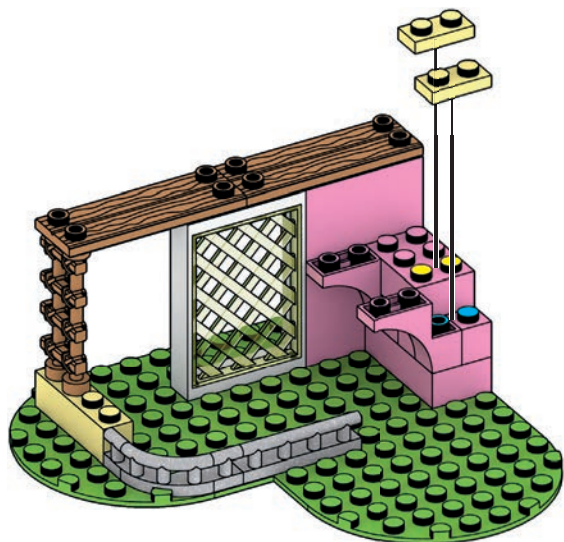

38

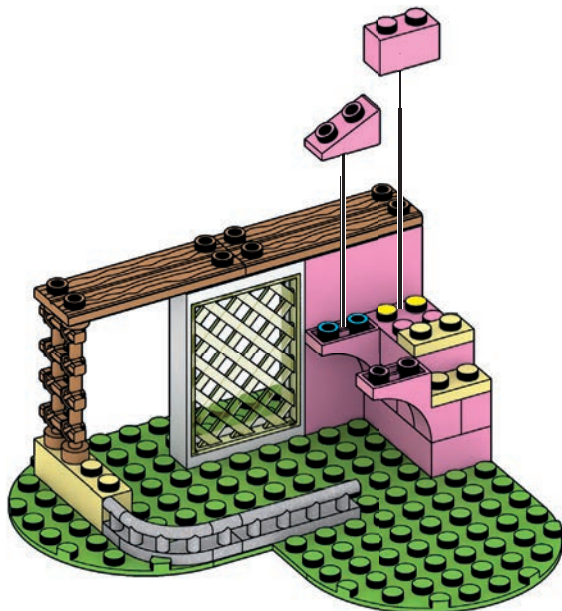
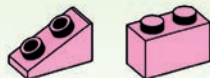

39

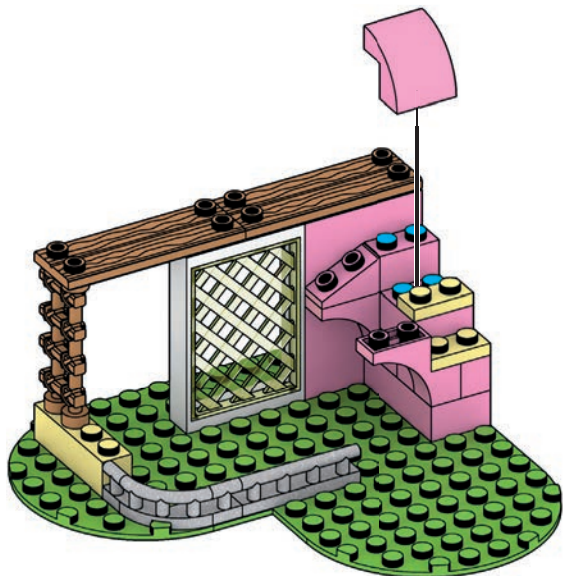

40

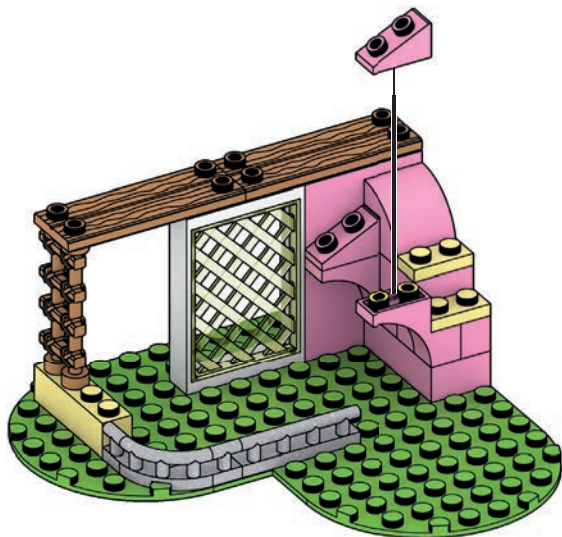

41

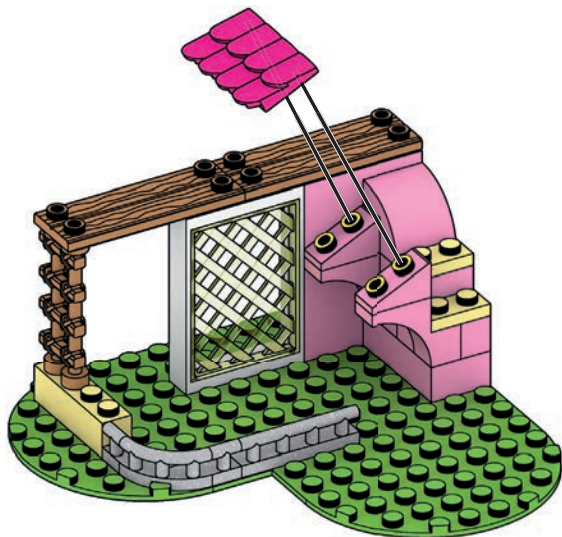

42

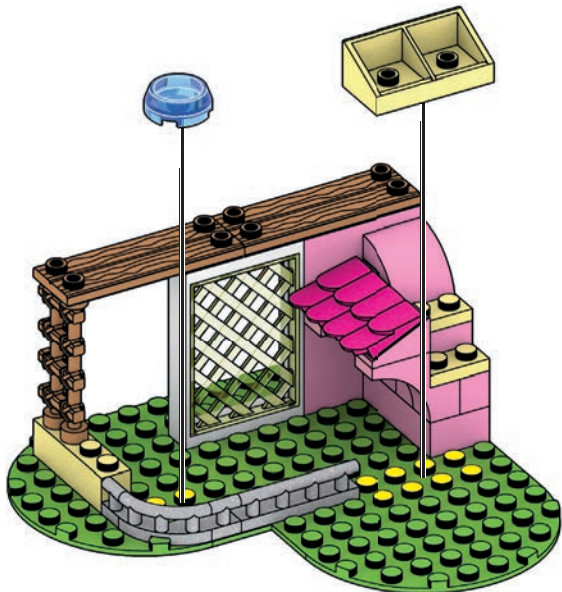

43

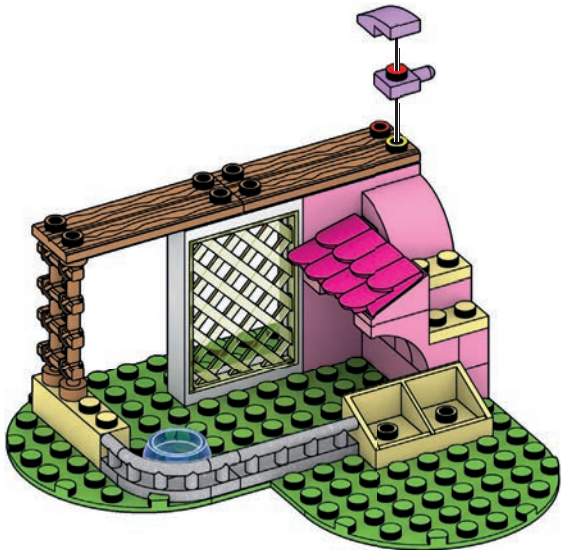
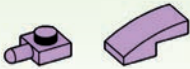

44

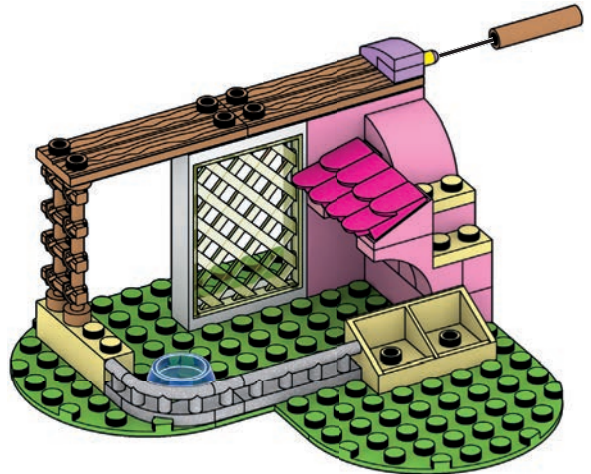
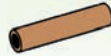

45

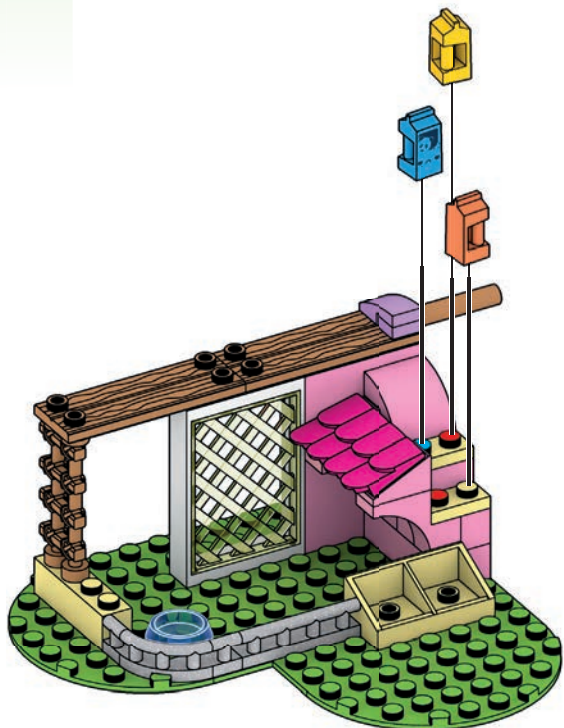

46

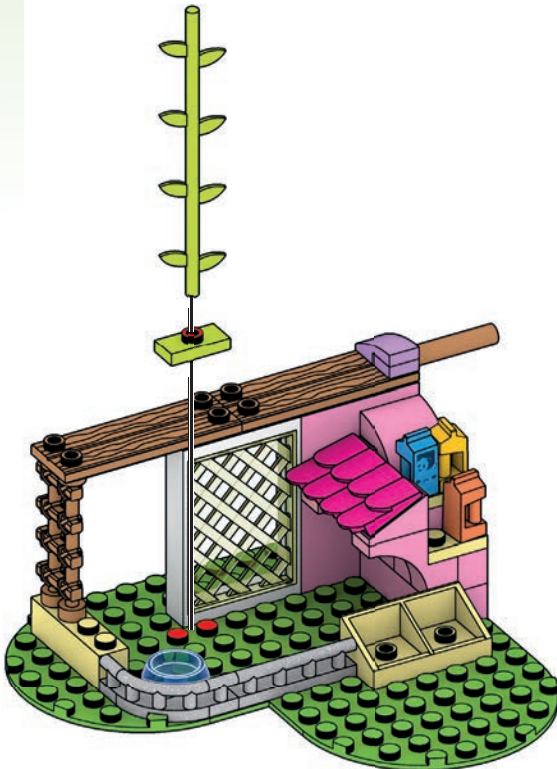

47

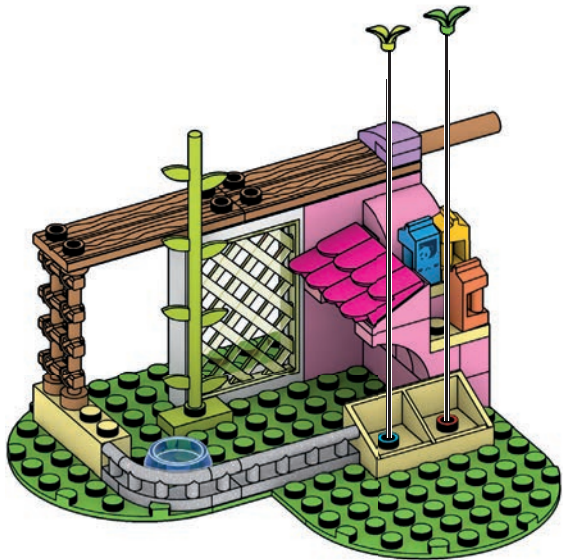

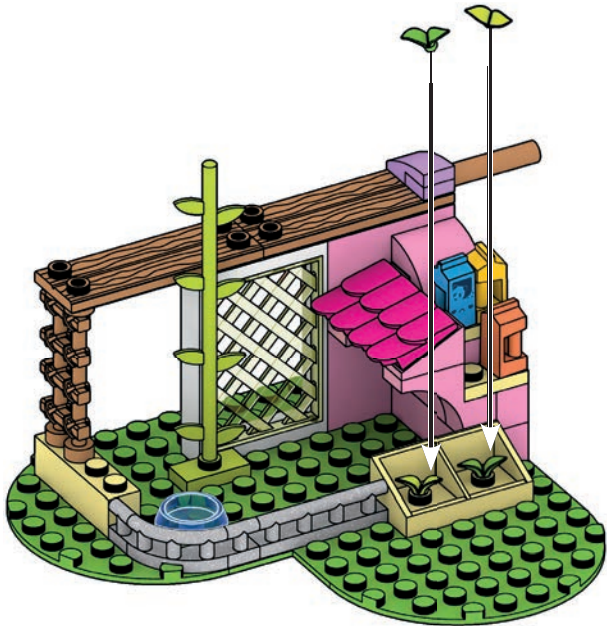

49

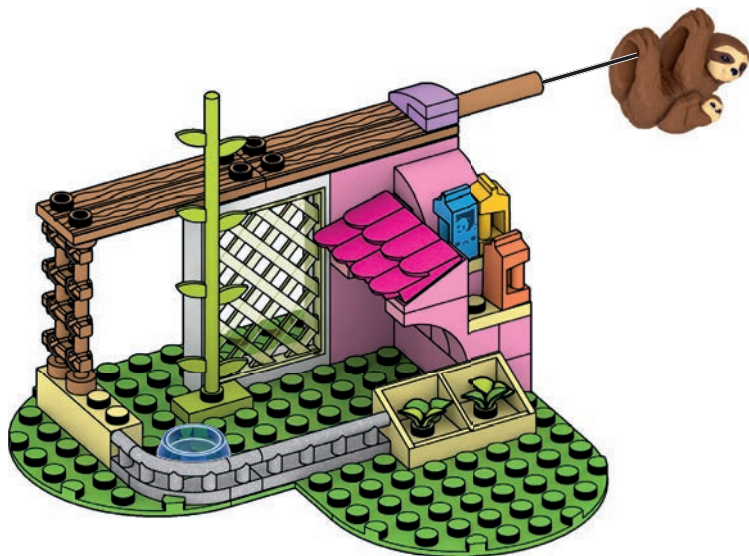

50

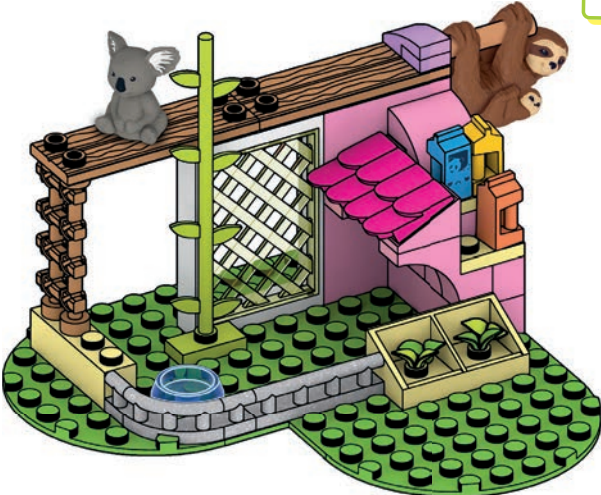

LET'S PLAY! AMUSONS-NOUS!

İZJUGARI • A BRINCAR!
LASS UNS SPIELEN! • НАИГНАЕМ ИГРУ!



2X
AM78803HT



2X
AM78803BBG



1X
AM08417Z



4X
AM81164NU



1X
AM01140NL



2X
AM18591AAD



3X
AM18591GX



1X
AM19158APG



1X
AM76329APG



1X
AM76330APG



1X
AM72931APG



1X
AM72980FM



1X
AS-GYH09-06



1X
AM72982FM



1X
AS-GYH09-02



1X
AS-GYH09-03



1X
AS-GYH09-04



1X
AS-GYH09-05



1X
AS-GYH09-07



1X
AM74016APG



1X
AM72972HJ



1X
AM18756APG



1X
AM07590APG



1X
AM07590BBG



2X
AM09393CS



1X
AM18901APG



2X
AM81095E



1X
AM78486NL



1X
AM07228E



2X
AM04429ASX



1X
AM09013ASX



2X
AM17153ASX



1X
AM19327BYE



1X
AM76653BYE



1X
AM72233VL



1X
AM16384GX



1X
AM03873AAD



1X
AM03873ASX





1X
AM81142E

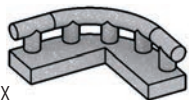

1X
AM77415APG

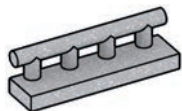

1X
AM01847APG

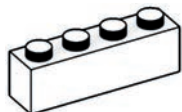

1X
AM01087E

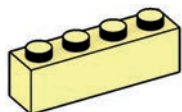

1X
AM01087CS



1x
AM81161ATC

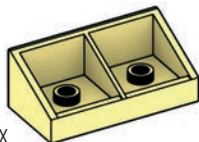

1X
AM19754CS

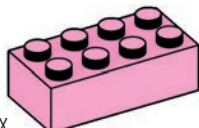

1X
AM09033ASX

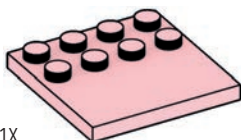

1X
AM18617NU

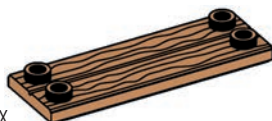

2X
AM79449VL



1X
AM08481ASX

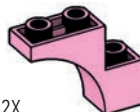

2X
AM78916ASX



1X
AM79245VL



1X
AM16289ASX

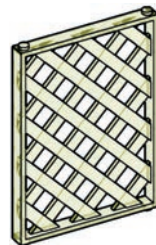

1X
AM78723Z

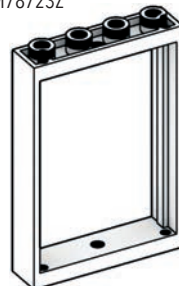

1X
AM76416E

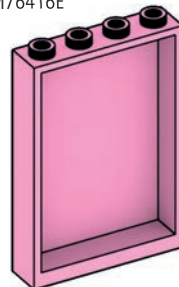

1X
AM16311ASX

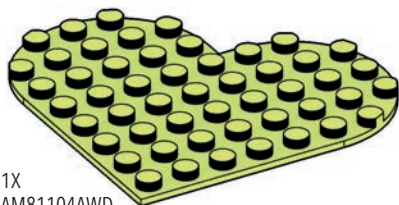

1X
AM81104AWD

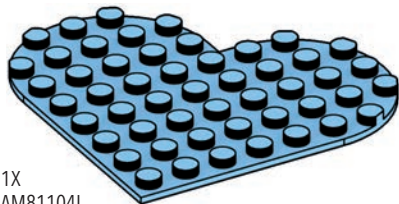

1X
AM81104I



1X
AM78727BBG

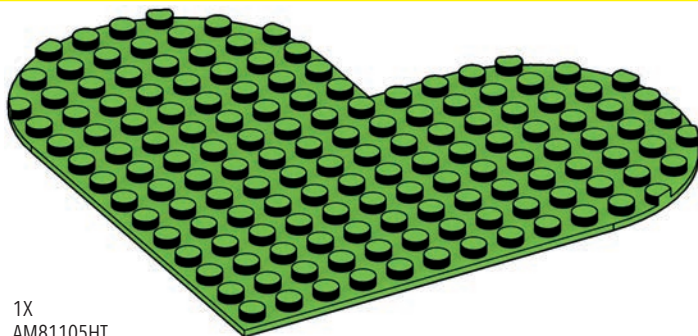

1X
AM81105HT



1X
AM81278AEN



1X
FIG-GYH09-H



1X
AM81278AML



1X
FIG-GYH09-F



1X
FIG-GYH09-E



1X
FIG-GYH09-G



1X
FIG-GYH09-D

**Missing pieces?
Pièces manquantes?**

¿Partes faltantes? • Perdeu peças?
Fehlen Teile? • Не хватает деталей?

support.megabrands.com



1X
FIG-GYH09-A

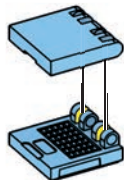

1X
FIG-GYH09-B



1X
FIG-GYH09-C

Mattel Europa B.V., Gondel 1, 1186 MJ Amstelveen, Nederland. Mattel U.K. Limited, The Porter Building, 1 Brunel Way, Slough SL1 1FQ, UK. Mattel France, Parc de la Cerisaie, 1/3/5 allée des Fleurs, 94260 Fresnes Cedex. N° Cristal 0969 36 99 99 (Numéro non surtaxé) ou www.lesjouetsmattel.fr Mattel Belgium, Trade Mart, Atomiumsquare, Bogota 20 - B 275, 1020 Brussels. Grátis nummer België: 0800 - 16 936 - 6818 nummer Luxemburg: 800 - 22 784 - Grátis nummer Nederland: 0800 - 262 88 35. Deutschland : Mattel GmbH, Solmsstraße 4, D-60486 Frankfurt am Main. Schweiz: Mattel AG, Kirchstrasse 24, CH-3097 Liebefeld. Österreich: Mattel Ges.m.b.H., Campus 21, Liebermannstraße A01 404, A- 2345 Brunn/Geirgube, Mattel Italy Srl, Via Bracco, 6-MAC 6, 20159 Milano, Italy. Servizio assistenza clienti: Customer.rivitalia@mattel.com - Numero verde 800 11 37 11. Mattel España, S.A., Aribau 200, 08036 Barcelona. cservice.spain@mattel.com Tel: 902203010 http://www.service.mattel.com/es. Mattel East Asia Ltd., Room 503-09, North Tower, World Finance Centre, Harbour City, Tsimshatsui, HK, China. Tel.: (852) 3185-6500. Diimport & Diederkan (Oleh): Mattel Continental Asia Sdn Bhd. Level 19, Tower 3, Avenue 7, No. 8 Jalan Kerinchi, Bangsar South, 59200 Kuala Lumpur, Malaysia. Mattel South Africa (PTY) LTD, Office 102/13, 30 Melrose Boulevard, Johannesburg 2196. Dystrybutor: Mattel Poland Sp. z o.o., Warsaw Trade Tower 34 p., ul. Chłodna 51, 00-867 Warszawa. Mattel Australia Pty. Ltd., 658 Church St., Richmond, Victoria, 3121. Consumer Advisory Service - 1300 135 312. Mattel AEBE, ΕΒΨύχου Μοκαρίου 1, Κηρίου Κ-2, ΤΚ 17561, Παλαιό Φάληρο. Mattel Oyuncakçılık Tic. Ltd. Şti. İcerenkoy Mah., Erkut Sok. A Blok No:12 Üner Plaza Kat:9 10 34752 Ataşehir İstanbul. Tel: 0216 570 75 00. Импортер/Уполномоченная организация: ООО "МАТТЕЛ" Российская Федерация, 105120 Москва, 2-й Сыромятинский переулок 1; +7 495 287 79 39. Forg.: Mattel Toys Hungary Kft 1139 Budapest Váci uti 91. +36 1 270 0223. Mattel Czech Republic s.r.o., The Forum, Václavské nám. 19, 11000 Praha1. Mattel, 333 Continental Boulevard, El Segundo, CA 90245, USA. Consumer Services: 1-800-465-MEGA (6342). Importado y distribuido por Mattel de México, S.A. de C.V., Miguel de Cervantes Saavedra No. 193, Pisos 10 y 11, Col. Granada, Alcaldía Miguel Hidalgo, C.P. 11520, México, Ciudad de México, R.F.C. MME-920701-NB3. Tels.: 59-05-51-50. Ext. 5206 ó 01-800-463-59-89. Mattel Chile, S.A., Avenida Américo Vespucio 501-B, Quilicura, Santiago. Tel.: 1230-020-6213. Servicio al consumidor Venezuela: Tel.: 0-800-100-9123. Mattel Argentina, S.A., Av. Libertador 1000, Piso 11 – Oficinas 109 y 111, Vicente López – Prov. Buenos Aires. Tel.: 0800-666-3373. San Isidro, Colombia, S.A., Calle 12347-07 P5, Bogotá. Tel.: 01800-710-2069. Mattel Perú, S.A., Av. Juan de Arona n° 151, Centro Empresarial Juan de Arona, Torre C, PISO 7, Oficina 704, San Lázaro, Lima 27, Perú. RUC: 20425853865. Reg. Importador: 02350-12-IUE-DIGESA. Tel.: 0800-54744. E-mail Latinoamérica: servicio.clientes@mattel.com. Mattel do Brasil Ltda. - CNPJ : 54.558.002/0001-20 - Rua Verbo Divino, 1488 - 2º. Andar - 04719-904 - Chácara Santo Antonio - São Paulo - SP - Brasil. Serviço de Atendimento ao Consumidor: fone 0800 575 0780. E-mail: sac.mattel@dobrazil@mattel.com

ANIMAL GROOMING STATION | SALON DE TOILETTAGE | TIERPFLEGESTATION | TOILETTATURA DEGLI ANIMALI | DIERENKAPSALON | ESTACIÓN DE CUIDADO PARA ANIMALITOS | ESTAÇÃO DE CUIDADOS PARA OS ANIMAIZINHOS | STATION FÖR HUSDJURSKÖTSEL | DYREPLEJENUS | DYRESPA | SALON DLA ZWIERZĄT | ÁLLATGONDOZÓ | САЛОН ДЛЯ УХОДА ЗА ЖИВОТНЫМИ | ΣΤΑΘΜΟΣ ΠΕΡΙΠΟΤΗΣΗΣ ΖΩΩΝ | PET KUAFOR SALONU | محطة رعاية الحيوانات

⚠ WARNING:
CHOKING HAZARD. - Small parts.
Toy contains small balls.
Not for children under 3 years.

⚠ ATTENTION:
DANGER D'ÉTOUFFEMENT. - Présence de petits éléments.
Le jouet contient des petites balles.
Ne convient pas aux enfants de moins de 3 ans.

⚠ 警告:
のどにつまる危険 小さな部品が含まれています
小さな玉が含まれています。
3歳以下の子供には与えないで下さい。

⚠ تحذير:
ليست مناسبة للأطفال دون سن 36 شهراً - قطع صغيرة.
كرات صغيرة. خطر الاختناق.

⚠ 警告!
本产品内含小零件和小球，可能产生窒息危险，不适合3岁以下儿童使用。

ADVERTENCIA: PELIGRO DE ATRAGANTAMIENTO. Juguete no recomendado para menores de 3 años, porque contiene piezas pequeñas / bolitas que podrían provocar asfixia en caso de ser ingeridas o inhaladas por el/la niño/a.

ATENÇÃO! Não indicado / não recomendável para crianças menores de 3 (três) anos por conter part(s) pequena(s) / bola(s) pequena(s) que pode(m) ser engolid(a)s ou aspirada(s) podendo provocar asfixia.

AVVERTENZA: Piccole parti. Piccole palle. Rischio di soffocamento.

ACHTUNG: Kleine Teile. Kleine Kugeln. Erstickungsgefahr.

OSTRZEŻENIE: Małe części. Małe kuleczki. Niebezpieczeństwo zadławienia.

WAARSCHUWING: Kleine onderdelen. Kleine balletjes. Verstikkingsgevaar.

ПРЕДУПРЕЖДЕНИЕ: Мелкие детали. Маленькие шарик. Опасность проглатывания.

ADVARESEL: Små dele. Små bolde/kugler. Kvælningsfare.

WARNING: Smådelar. Små bollar. Kvävningrisk.

ADVARESEL: Små deler. Små kuler. Kvælningsfare.

VAROITUS: Pieniä osia. Pieniä palloja. Tukehtumisvaara

ΠΡΟΣΟΧΗ: Μικρά κομμάτια. Μικρές μπάλες. Κίνδυνος Πνιγμού.

UYARI: Küçük parçalar. Küçük toplar. Yutma tehlikesi.

UPOZORNENÍ: Malé díly. Malé micky. Nebezpečí udušení.

UPOZORNENIE: Malé casti. Malé guľôčky. Nebezpečenstvo zadusenía.

FIGYELMEZTETÉS: Kis alkatrészek. Kis labdák. Fulladásveszély.





CONJUNTOS DE CONSTRUÇÃO
BAUSETS • НАБОРЫ КОНСТРУКТОРОВ



GWR79



GWR35



GWR34

MORE TO COLLECT!
ENCORE PLUS À COLLECTIONNER!
¡MÁS PARA COLECCIONAR! • MAIS PARA COLECCIONAR!
MEHR ZUM SAMMELN! • СОБИРАЙ БОЛЬШЕ!



GWR79

GWR35

GWR34

Mattel Canada Inc. Mississauga, Ontario L5R 3W2.
MADE IN CHINA. FABRIQUÉ EN CHINE. FABRICADO NA / HECHO EN CHINA.
ИЗГОТОВЛЕНО В КИТАЕ. ÇIN'DE ÜRETİLMİŞTİR. صنع في الصين

1186 MJ, 1, NL

© 2020, MEGA Brands &™ MEGA Brands; BARBIE and associated trademarks and trade dress are owned by and used under license from Mattel. BARBIE ainsi que les marques et designs y afférents appartiennent à, et sont utilisés sous licence de Mattel. © 2020 Mattel.
Printed in China / Imprimé en Chine AD-GYH09-01

Set(s) sold separately and subject to availability. / Ensemble(s) vendu(s) séparément. Certains produits peuvent ne pas être commercialisés. / Se vende(n) por separado y está(n) sujeto(s) a disponibilidad. / Conjunto(s) vendido(s) em separado e sujeito(s) à disponibilidade. / Set in vendita separatamente, secondo disponibilità. / Das/Die Set(s) sind separat erhältlich. / Zestaw(y) sprzedawany(e) oddzielnie w zależności od dostępności. / Set(s) apart verkrijgbaar en afhankelijk van beschikbaarheid. / Набор(ы) продаются отдельно, при наличии. / Sæt sælges separat og så længe lager haves. / Seten säljs separat så länge lagret räcker. / Settet/settene selges separat så langt lagret rekker. / Pakkaus/pakkaukset myydään erikseen, saatavuus voi vaihdella. / Το(α) σετ πωλούνται ξεχωριστά και ανάλογα με τη διαθεσιμότητα. / Setler ayrı olarak satılır ve stoklarla sınırlıdır. / Set (sety) se prodává (prodávají) samostatně dle aktuální nabídky. / Súprava/-y sa predáva(jú) samostatne a podľa dostupnosti. / A készlet(ek) külön kapható(k), az elérhetőség változhat. / セット商品は別売りになります。在庫状況は別途ご確認をお願いします。 / تباع المجموعة أو المجموعات على حدة وتخضع لتوافرها.

每套单独发售，按供货情况决定。

