



Barbie

Color Reveal



HHM01

DREAMHOUSE™
LA MAISON DE RÊVE DE BARBIE

LA CASA DE LOS SUEÑOS™ / A CASA DOS SONHOS / TRAUMVILLA / ДОМ МЕЧТЫ™

Living Room Salon

Salón • Sala de esta
Wohnzimmer • Гостиная

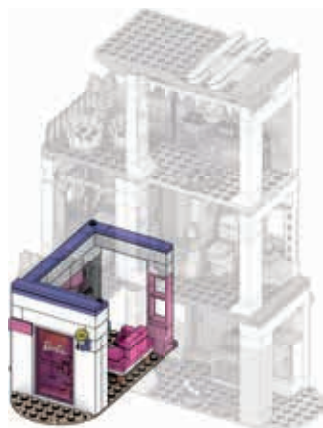

P.6

Kitchen Cuisine

Cocina • Cozinha
Küche • Кухня

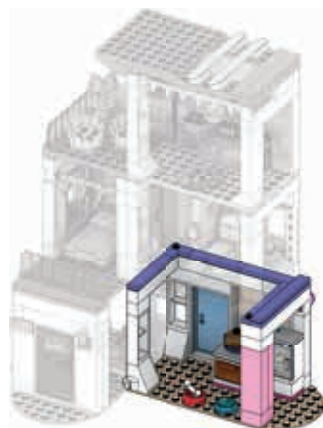

P.40

Bedroom Chambre

Dormitorio • Quarto
Schlafzimmer • Спальня



P.66

Bathroom Salle de bain

Baño • Casa de banho
Badezimmer • Ванная



P.94

Party Room Espace discothèque

Sala de fiestas • Salão de festas
Partyraum • Комната для вечеринок



P.120

Elevator Ascenseur

Ascensor • Elevador
Aufzug • Лифт



P.156

Dreamhouse™ Maison de Rêve

Dreamhouse™ • Casa de sonho
Traumhaus • Дом мечты



P.178





**Build
Construisez**
Construye | Constrói
Bauen | Стройте



Share | Partagez
Comparte | Partilha
Teilen | Делитесь

Devices not included | Aparelhos não incluídos | Dispositivos no incluido
Dispositivos não incluídos | Geräte nicht enthalten | Устройства не входят в комплект

**Play as you build!
Jouez en construisant!**

Juega mientras construyes!
Construção e brincadeira simultâneas!
Gleichzeitig bauen und spielen!
Строй и играй!



megaunboxed.com



P.183

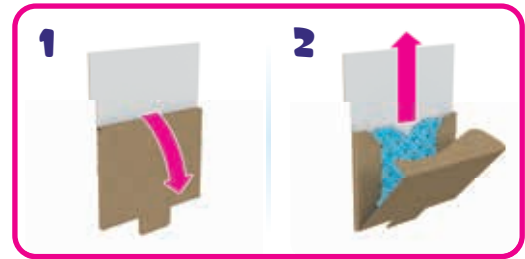

WHAT WILL YOU REVEAL? QU'ALLEZ-VOUS DÉCOUVRIR?

¿QUÉ VAS A REVELAR? • O QUE VOCÊ VAI REVELAR?
WELCHE PUPPE KOMMT ZUM VORSCHIEIN? • КАКУЮ КУКЛУ ВЫ ОТКРОЕТЕ?

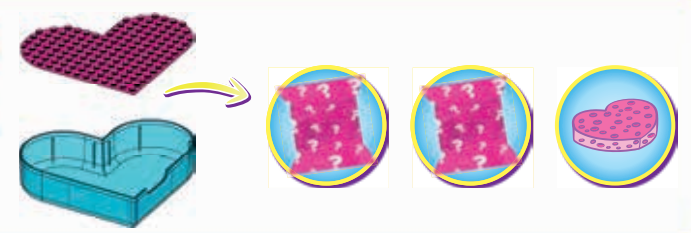



1



2





1



2





Let's Build the Living Room! Construisons le salon !

¡Vamos a construir el salón!
Vamos construir a sala de estar!
Das Wohnzimmer bauen!
Построим гостиную!

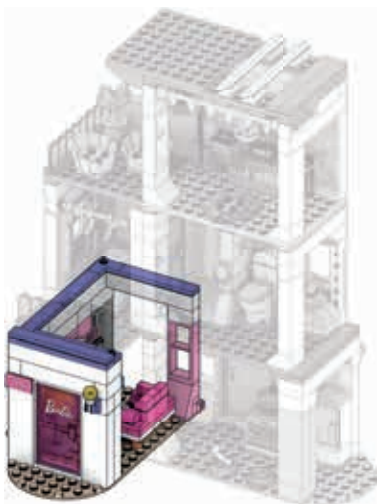

6



WHAT WILL YOU REVEAL? QU'ALLEZ-VOUS DÉCOUVRIR?

¿QUÉ VAS A REVELAR? • O QUE VOCÊ VAI REVELAR?
WELCHE PUPPE KOMMT ZUM VORSCHEN?
КАКУЮ КУКЛУ ВЫ ОТКРОЕТЕ?



**CUSTOMIZE YOUR BARBIE® MICRO-DOLL!
PERSONNALISEZ VOTRE MICRO-POUPÉE BARBIE®!**

¡PERSONALIZA TU MICROMUÑECA BARBIE®! • PERSONALIZE A SUA MICROBONECA BARBIE®!
DIE BARBIE MIKROPUPPE LÄSST SICH IMMER WIEDER NEU GESTALTEN! • СОЗДАЙТЕ СВОЮ МИКРОКУКЛУ BARBIE®!

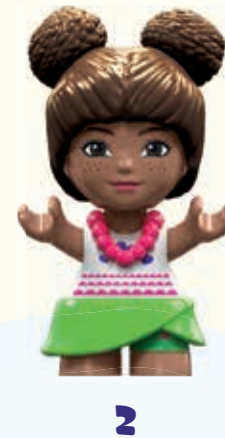
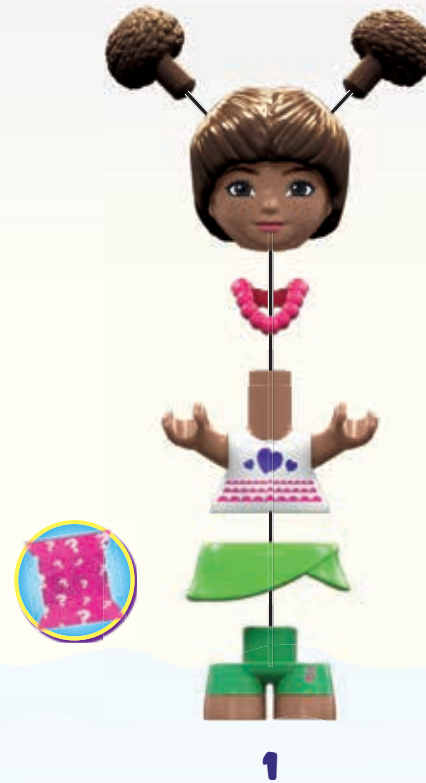



BUILDING TOOL OUTIL DE CONSTRUCTION

HERRAMIENTA DE CONSTRUCCIÓN
BAUWERKZEUG
FERRAMENTA DE MONTAGEM
ИНСТРУМЕНТ ДЛЯ
КОНСТРУИРОВАНИЯ

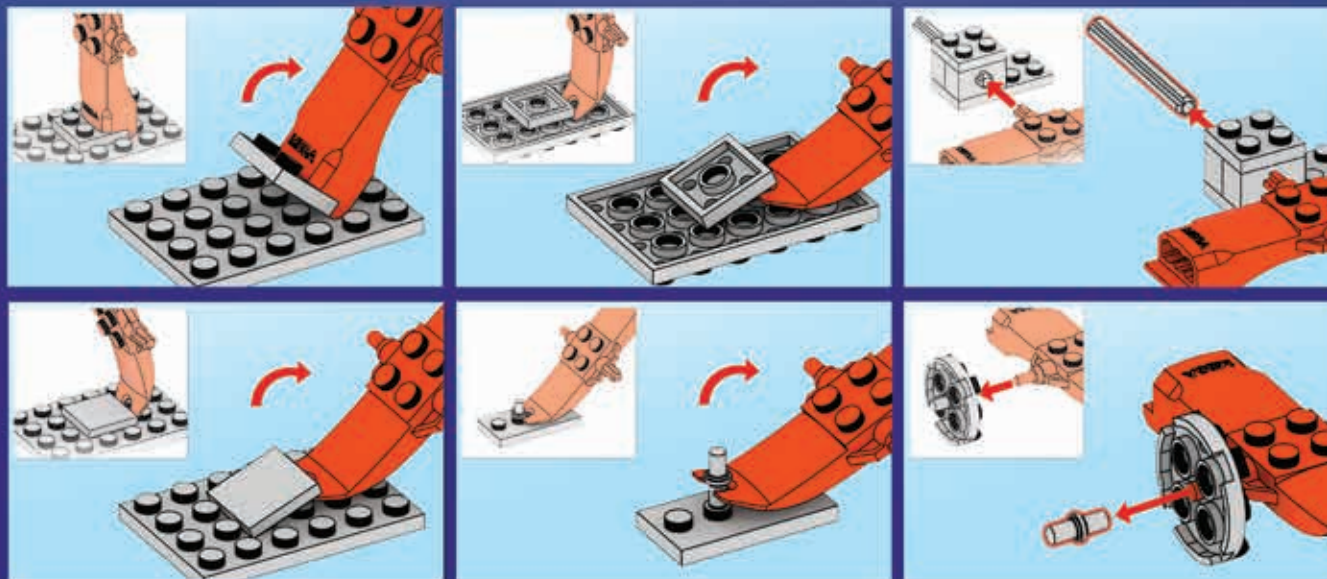



1

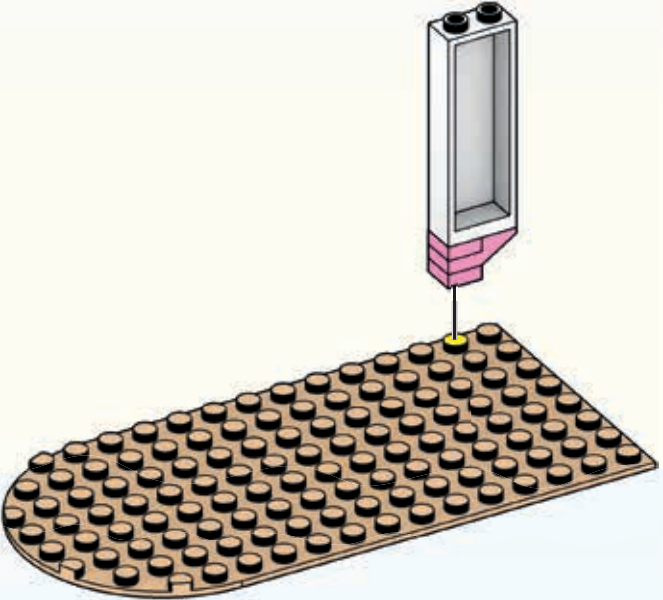
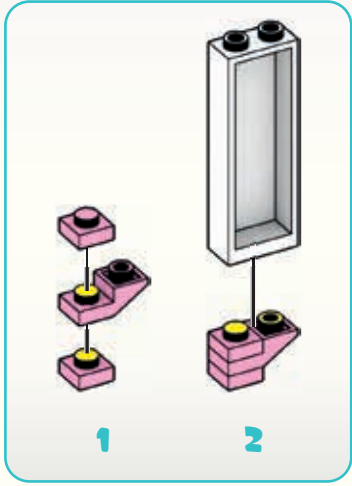
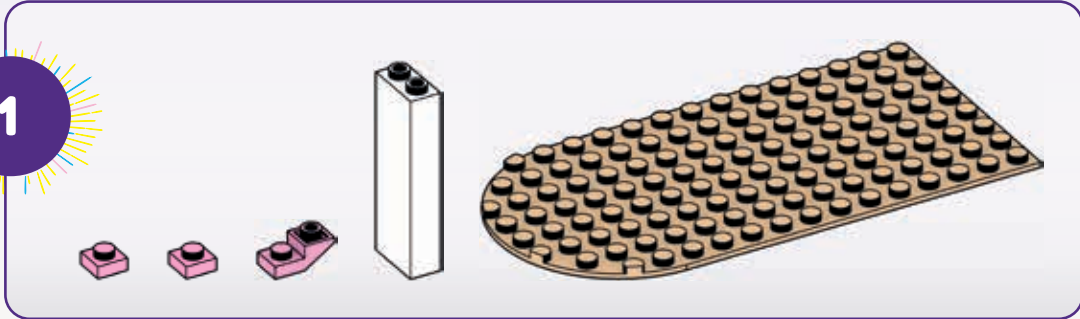

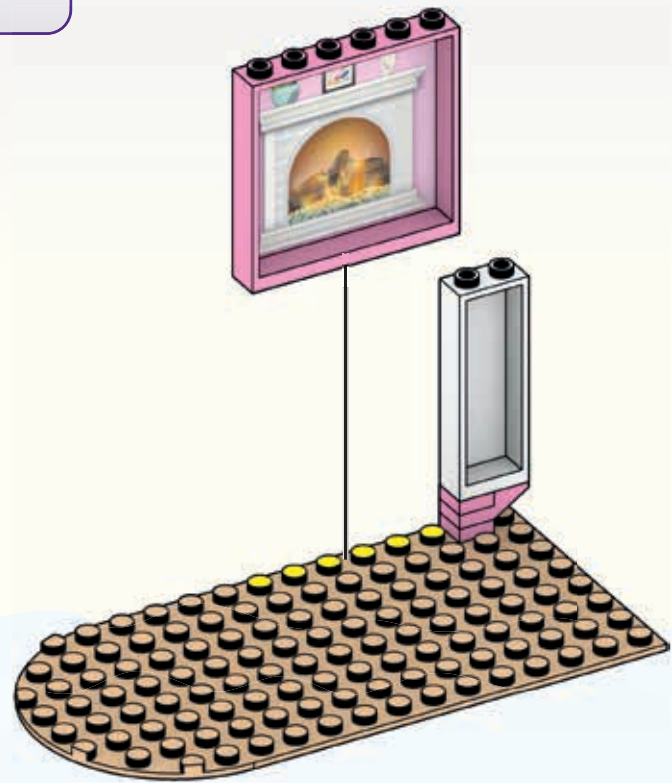



3

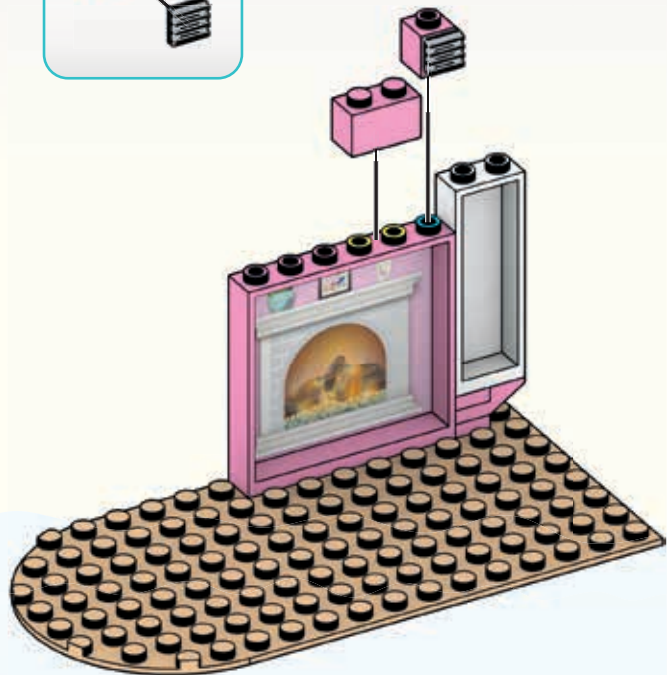
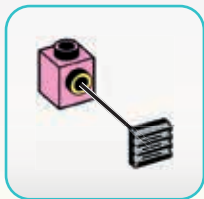

4

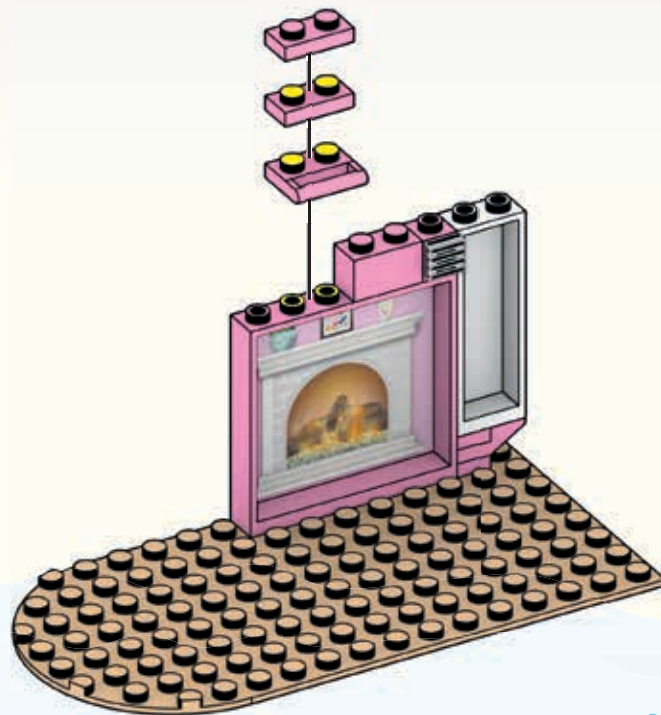

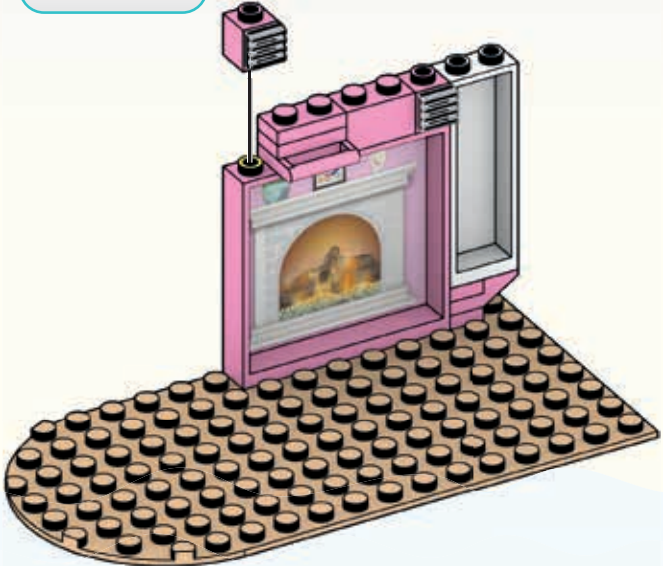

1

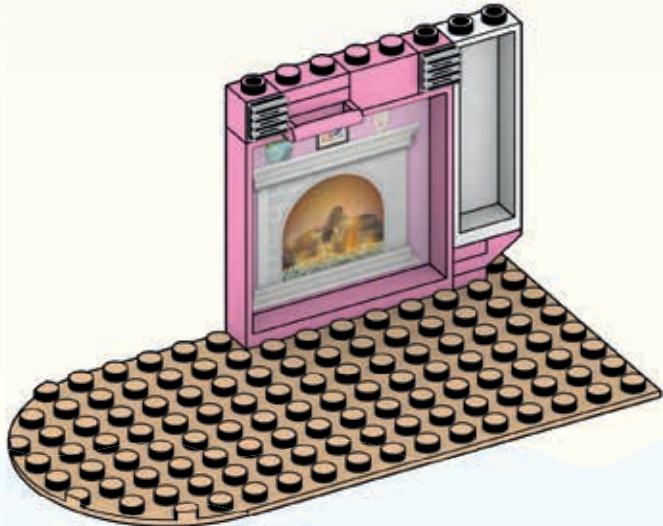

2



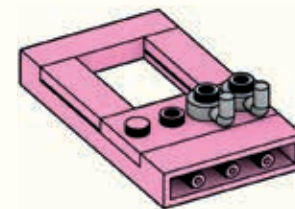
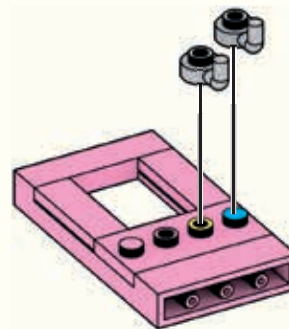
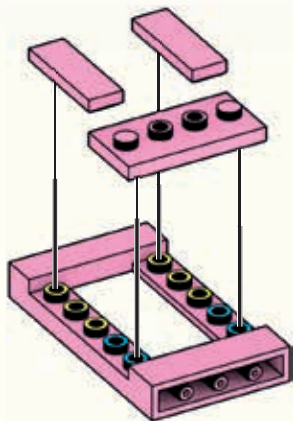
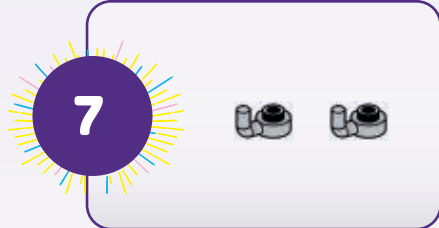
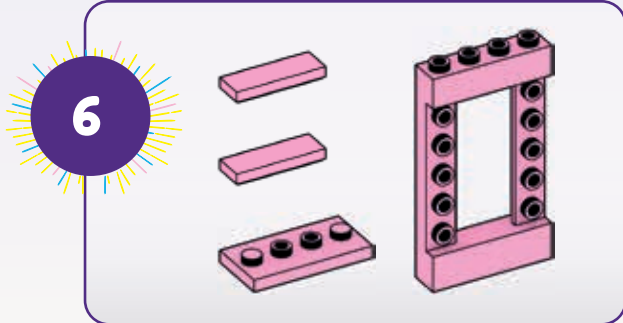



8

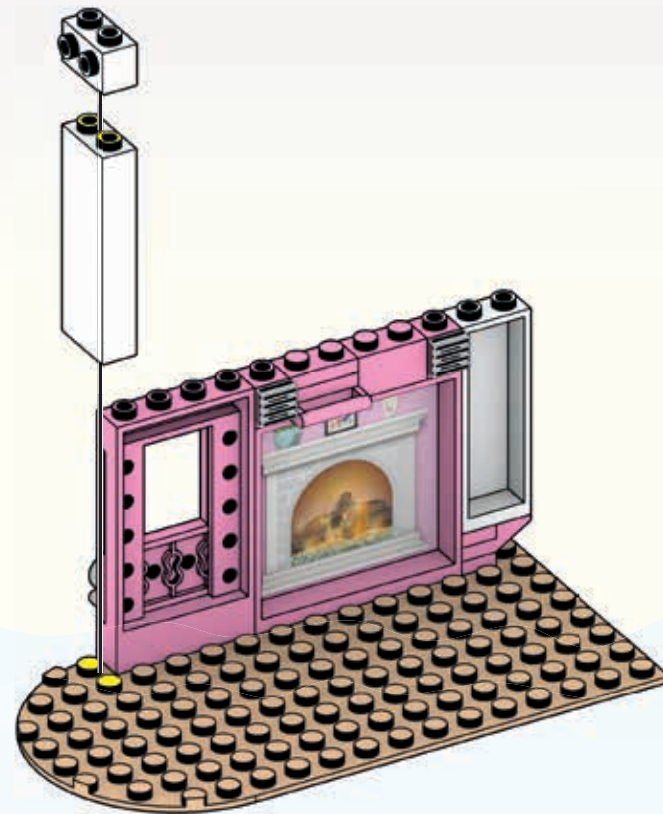
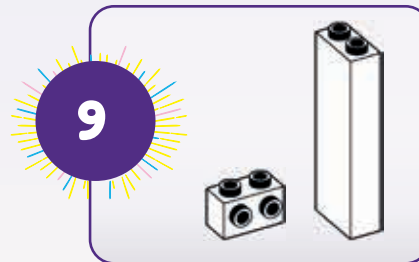
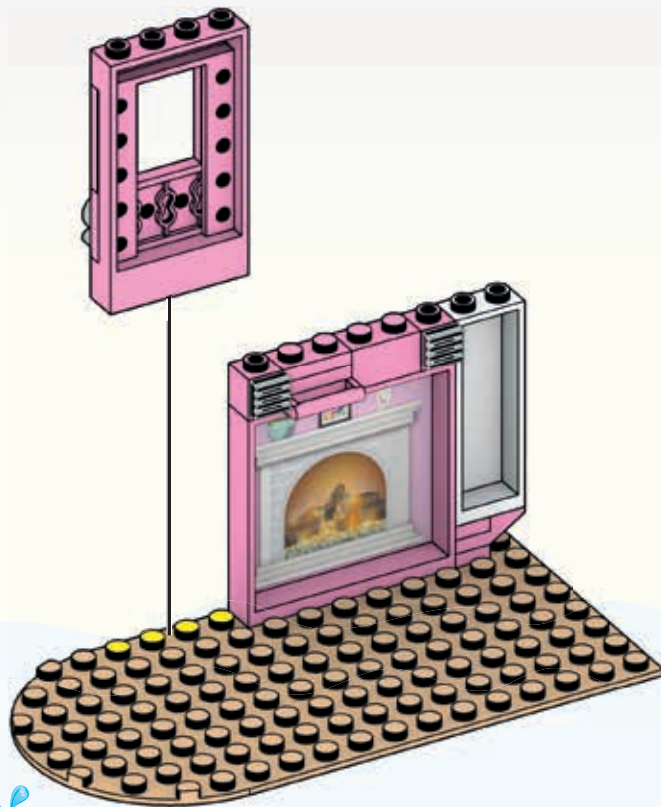

14





10

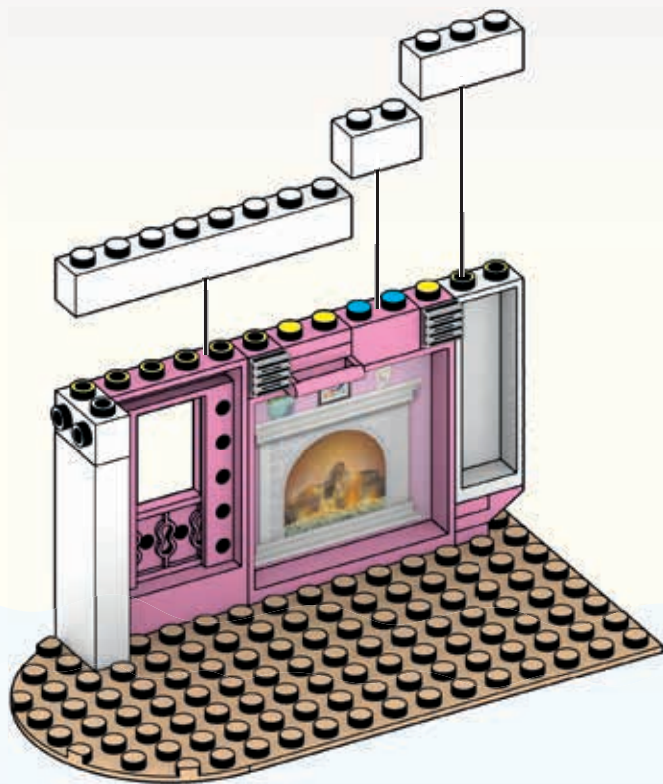
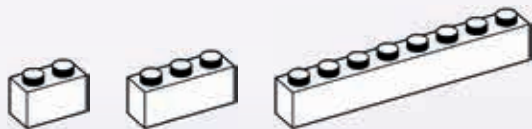

15





11

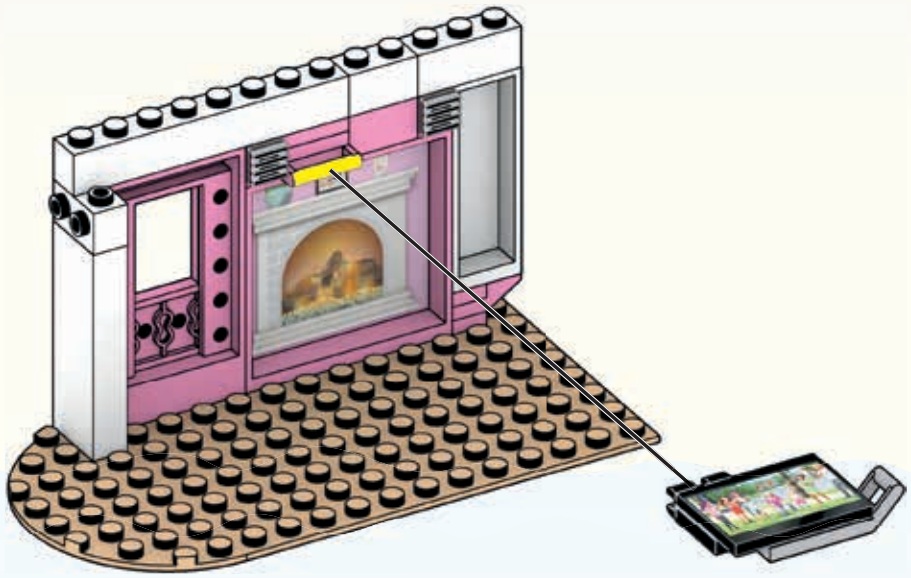
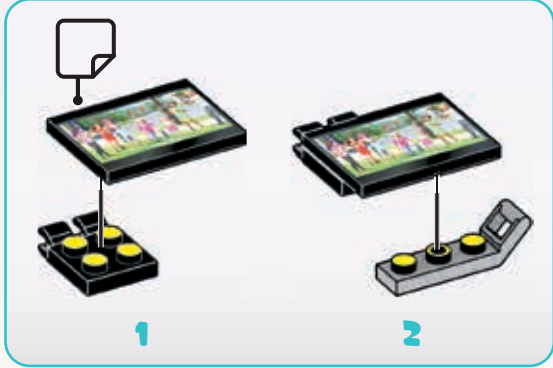
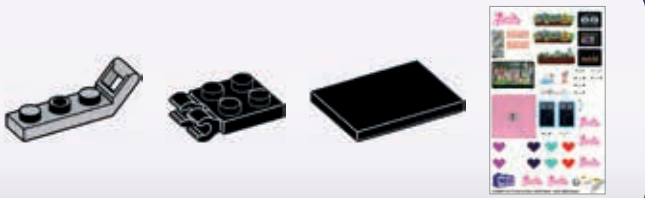

16



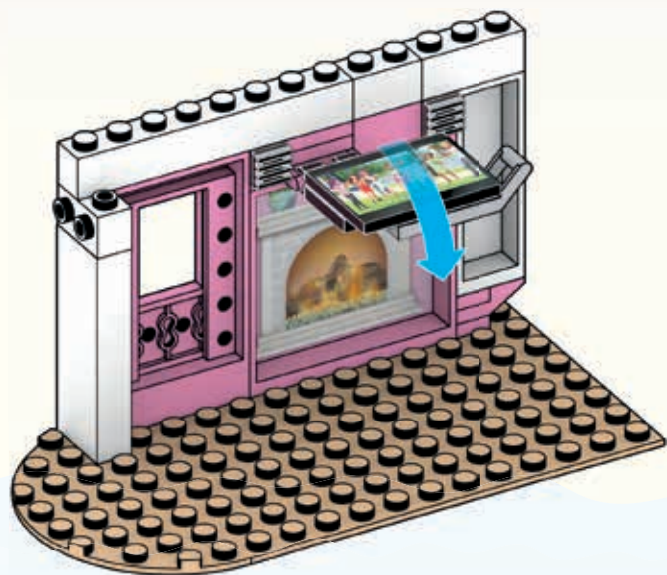

2

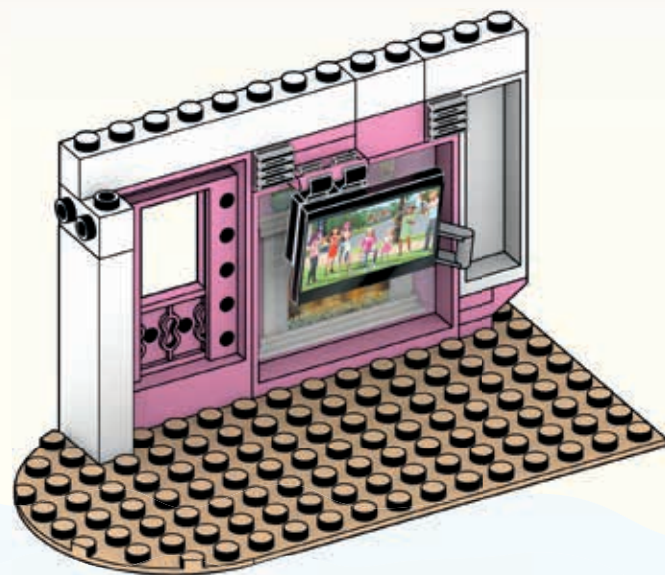

3





12

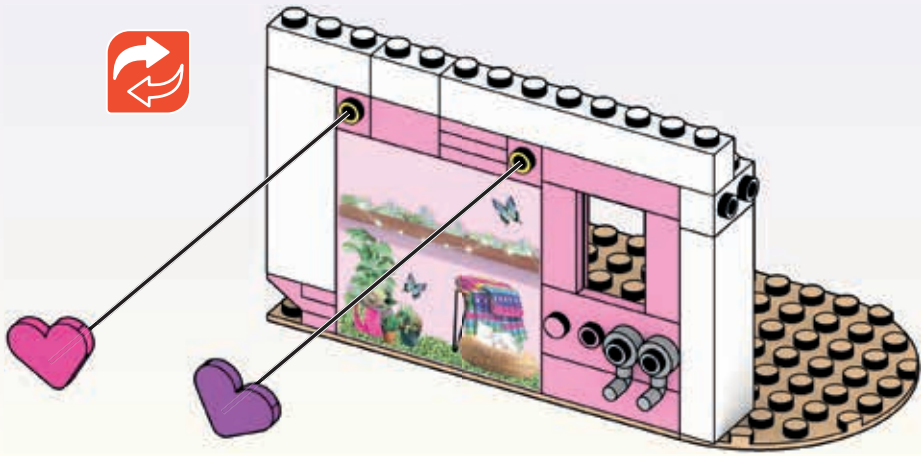
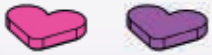

1

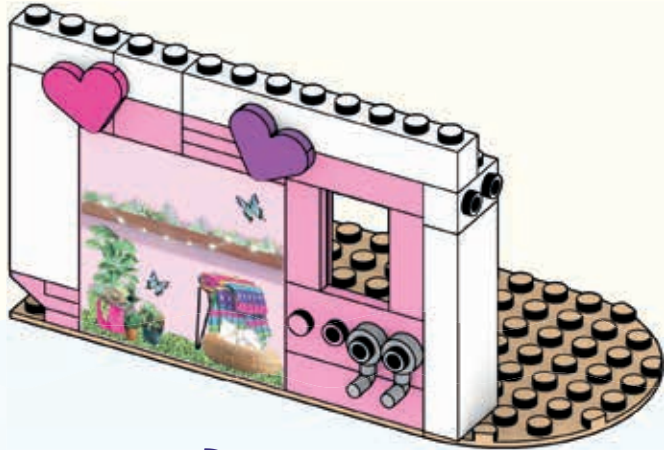

2



13



1

2

3





14

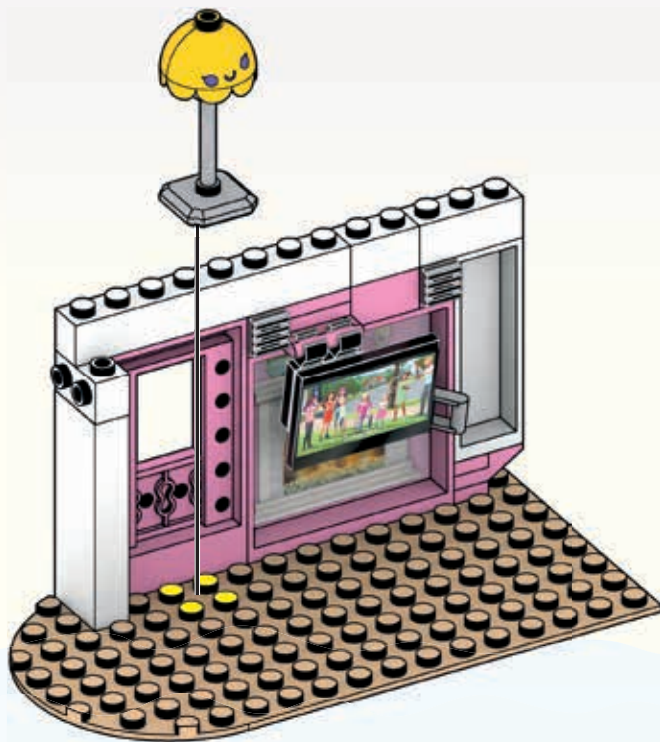

20





15

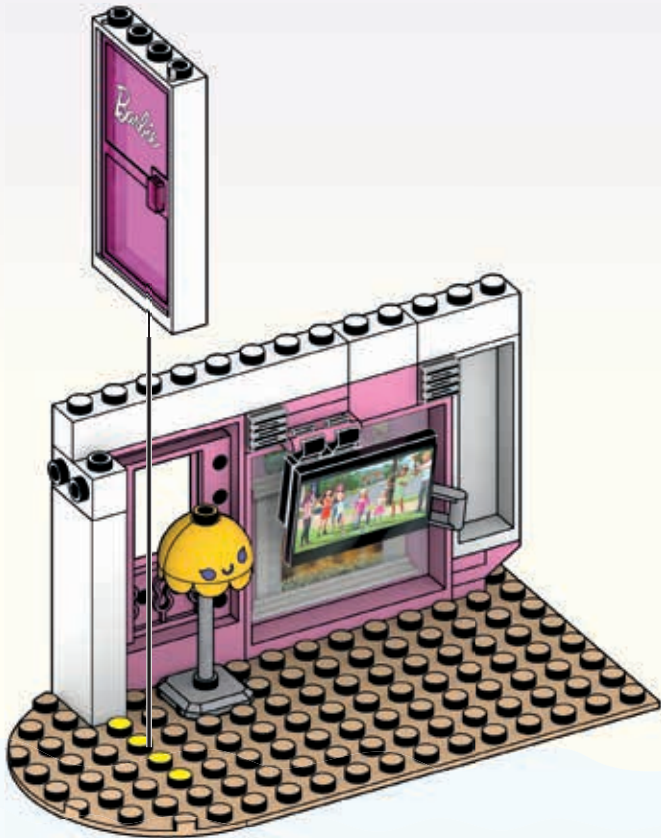



16

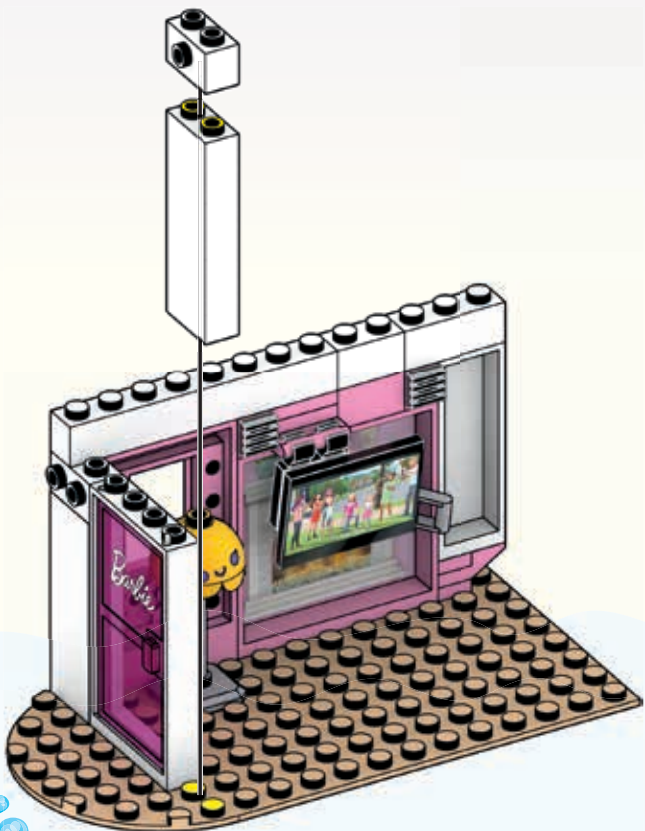
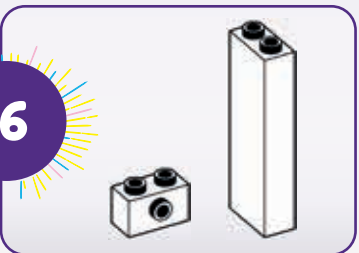

17

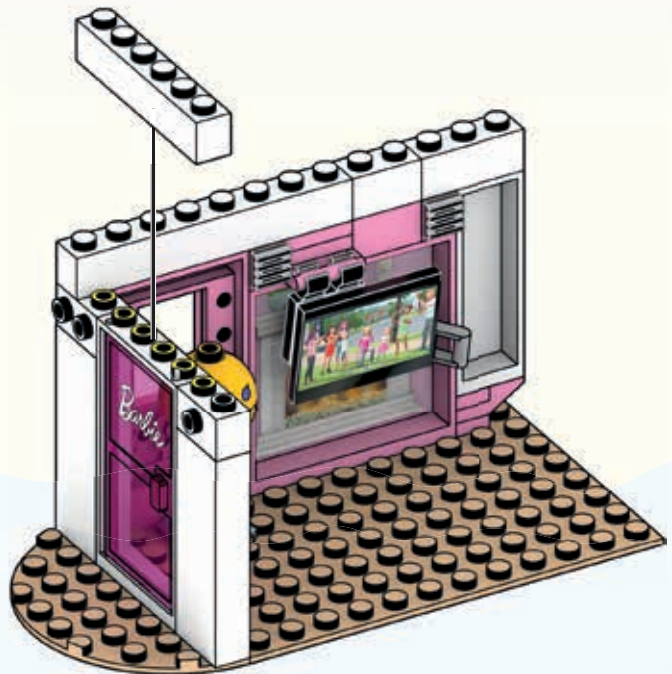
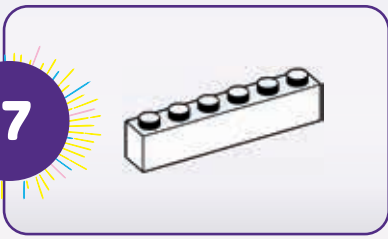

22



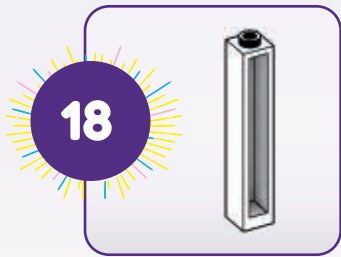

18

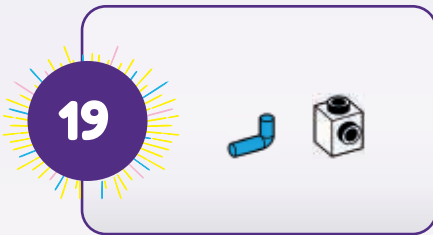
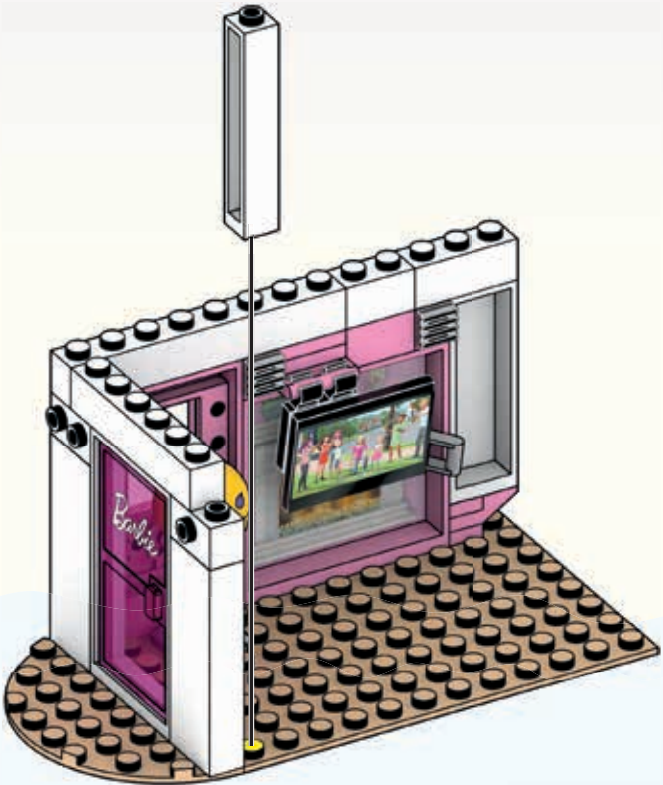

19

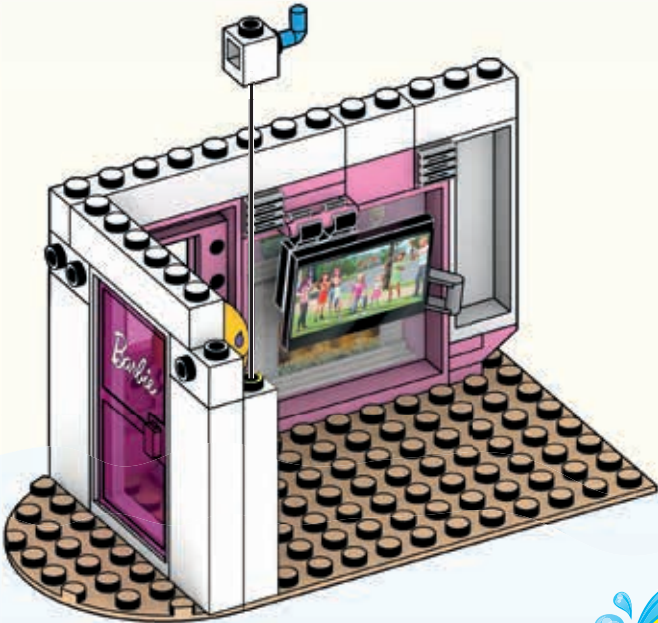
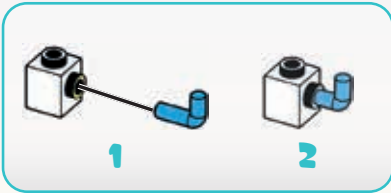

23



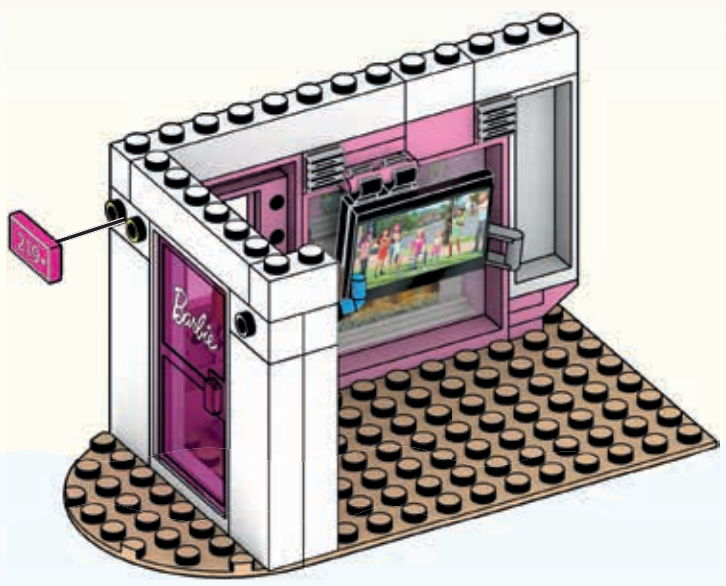
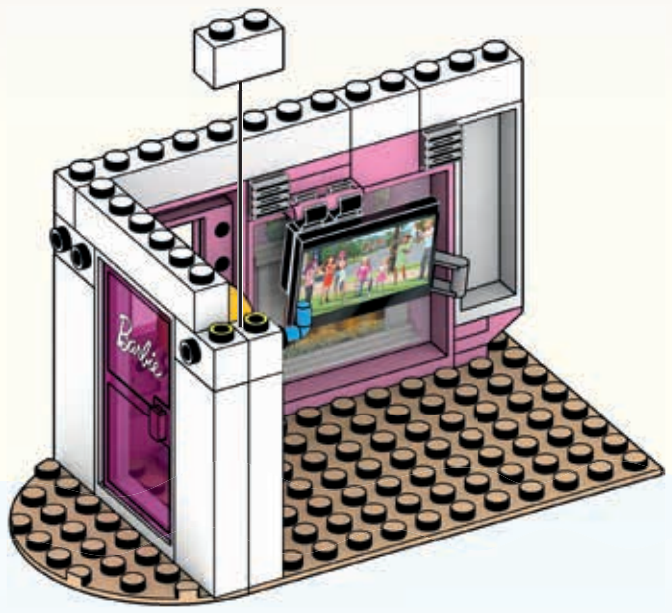
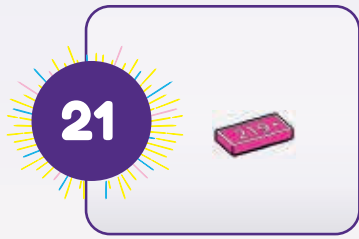
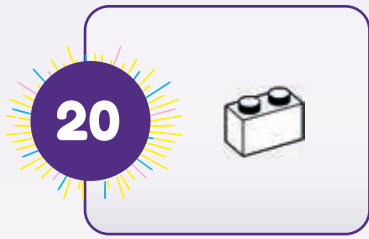



22

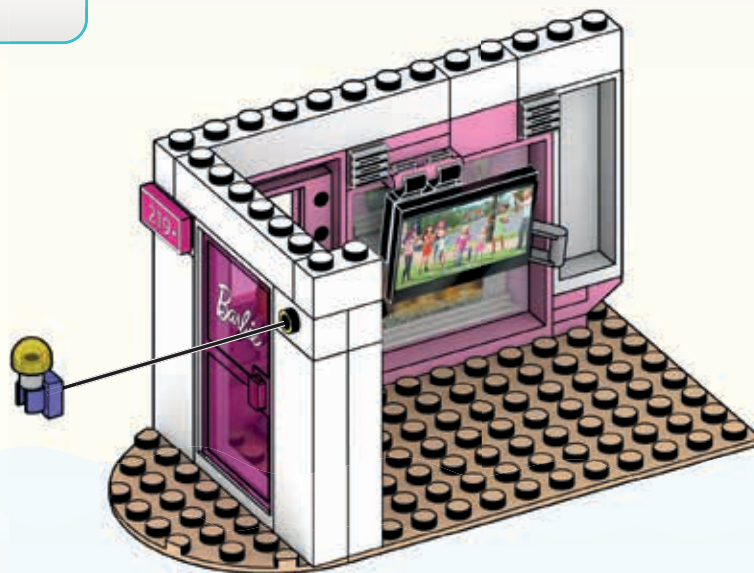
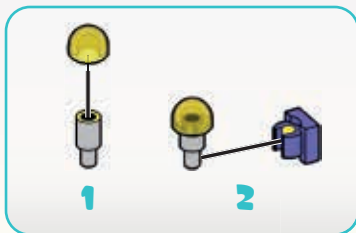

25



23

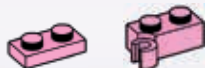

24

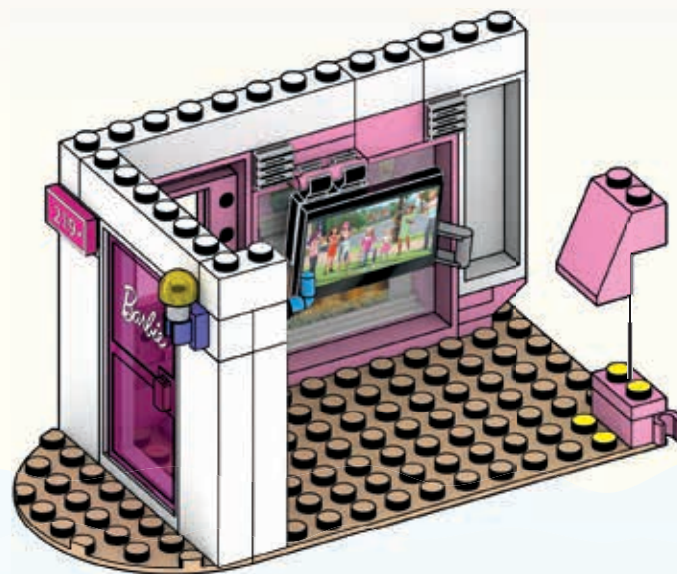
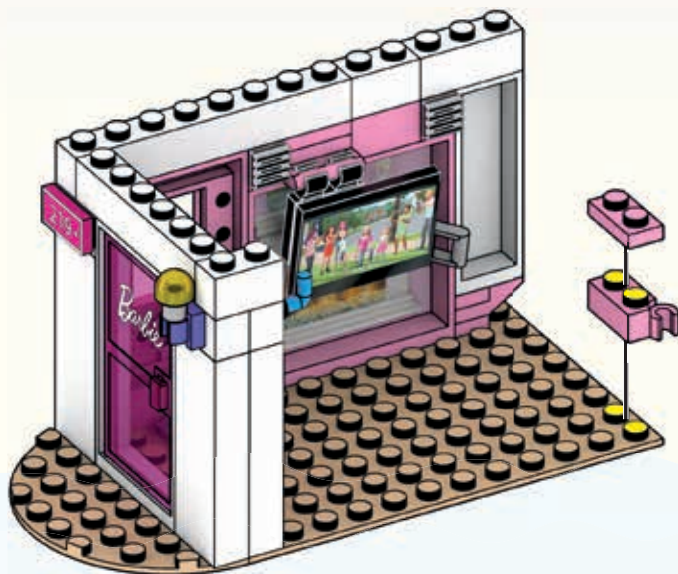

25



26

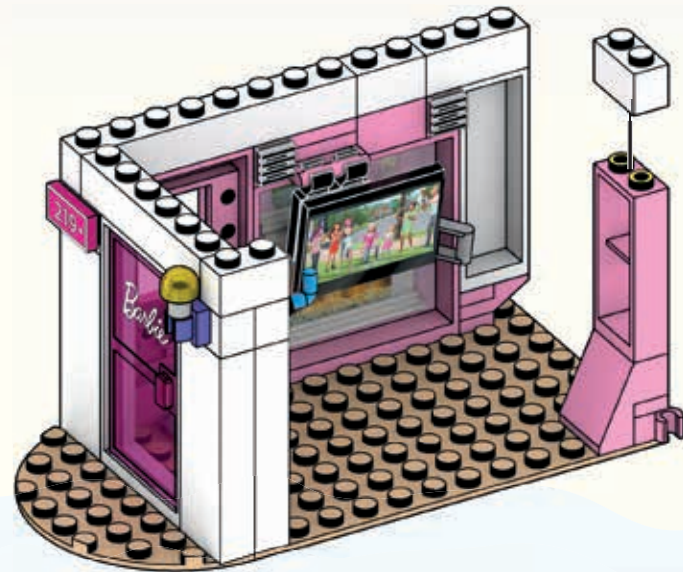
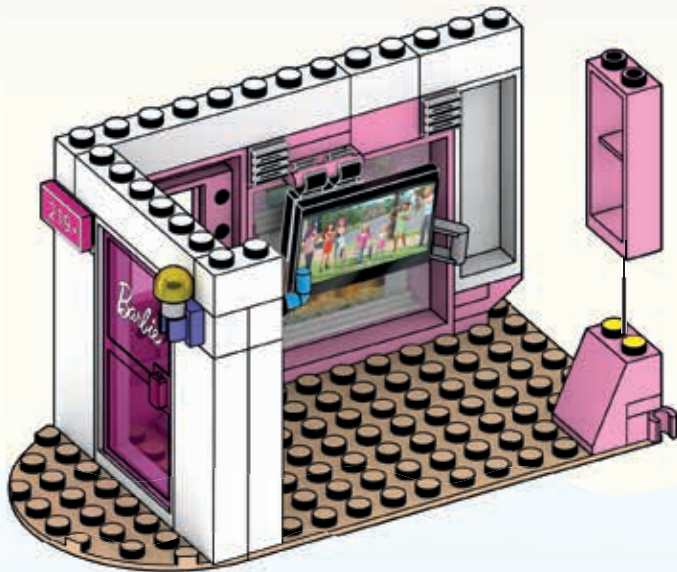

27

27

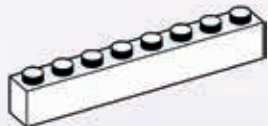

28

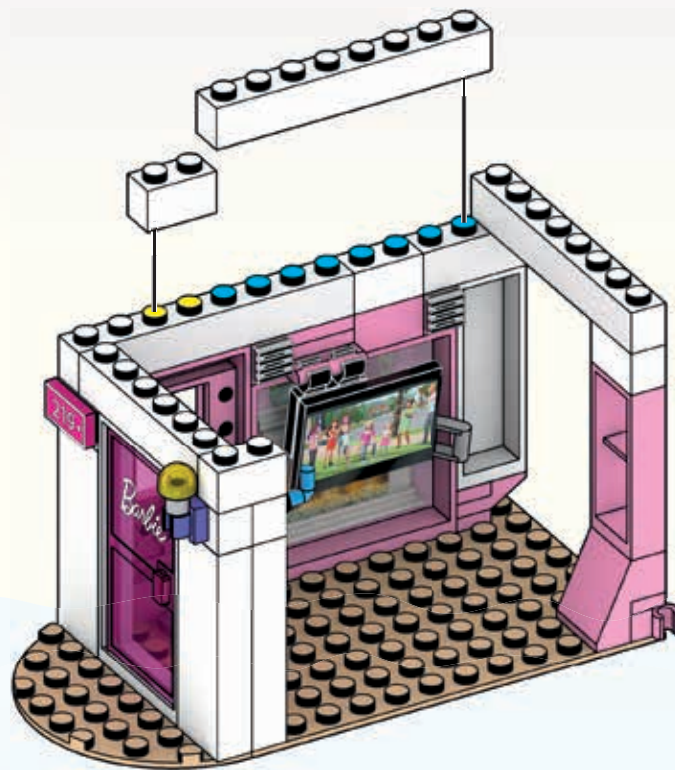
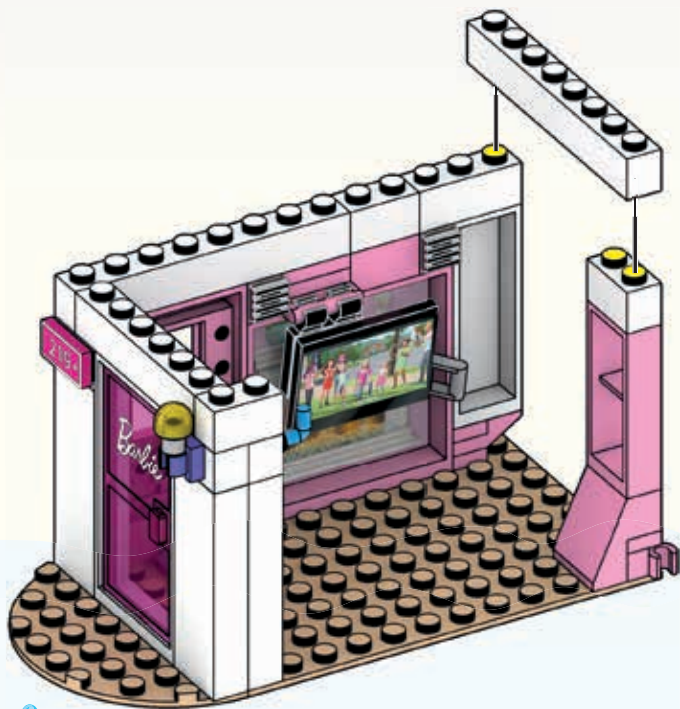

29

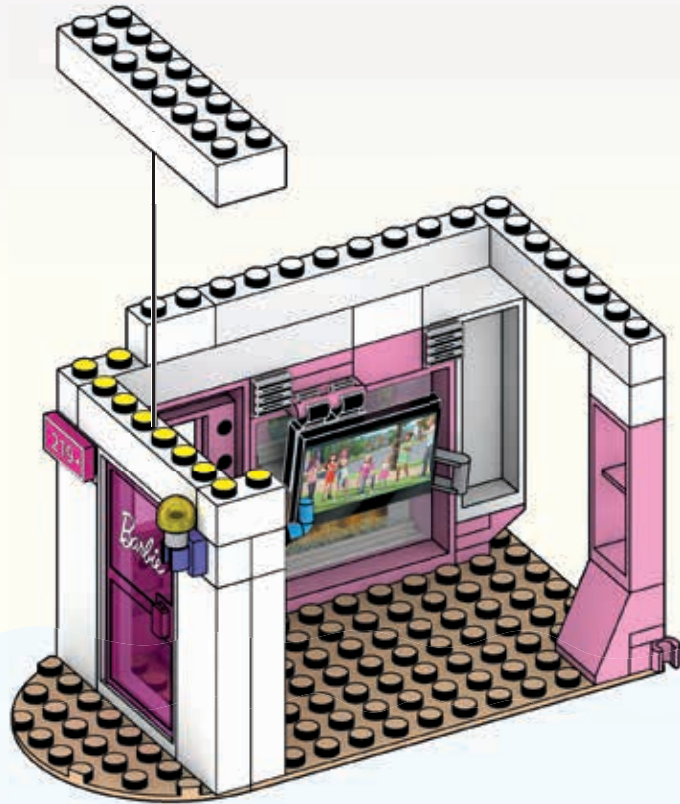

30

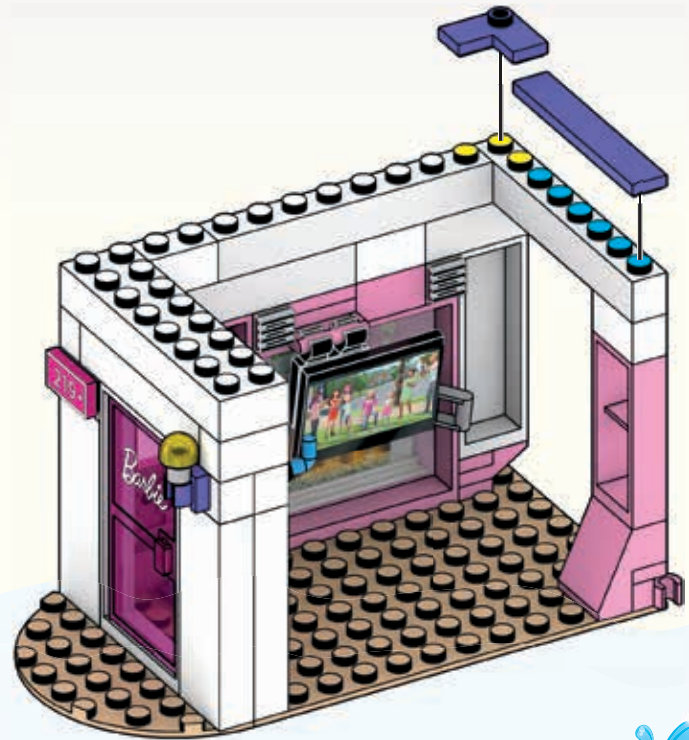

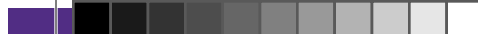

31



32

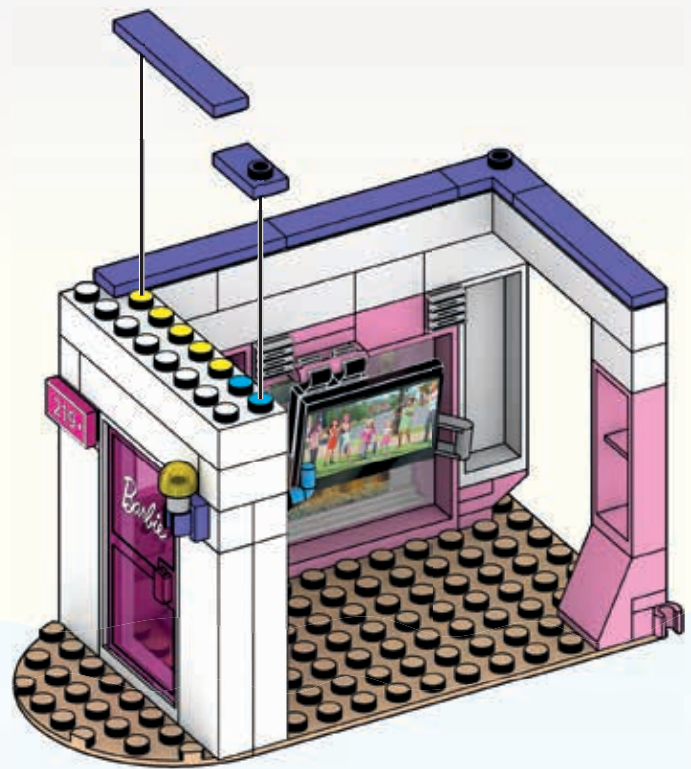
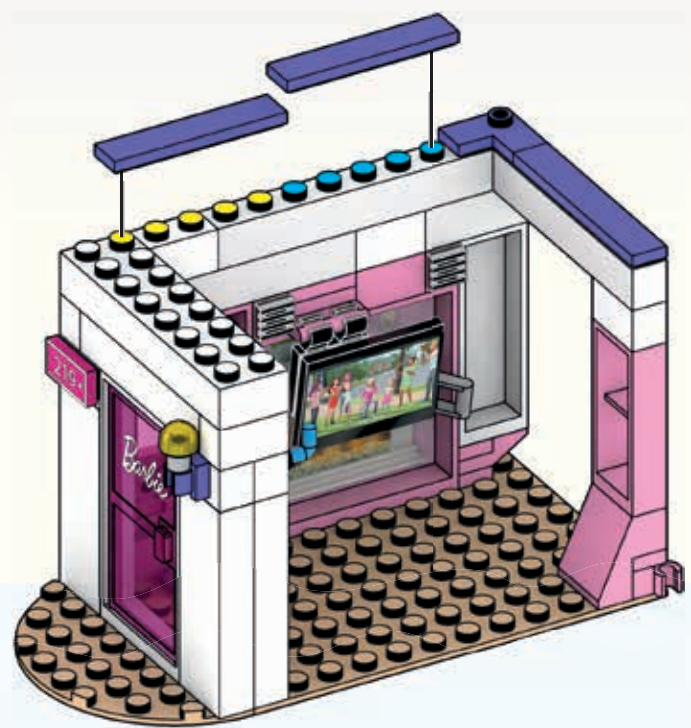

30



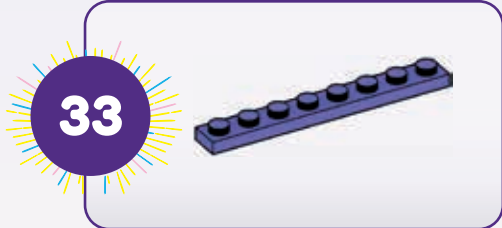

33

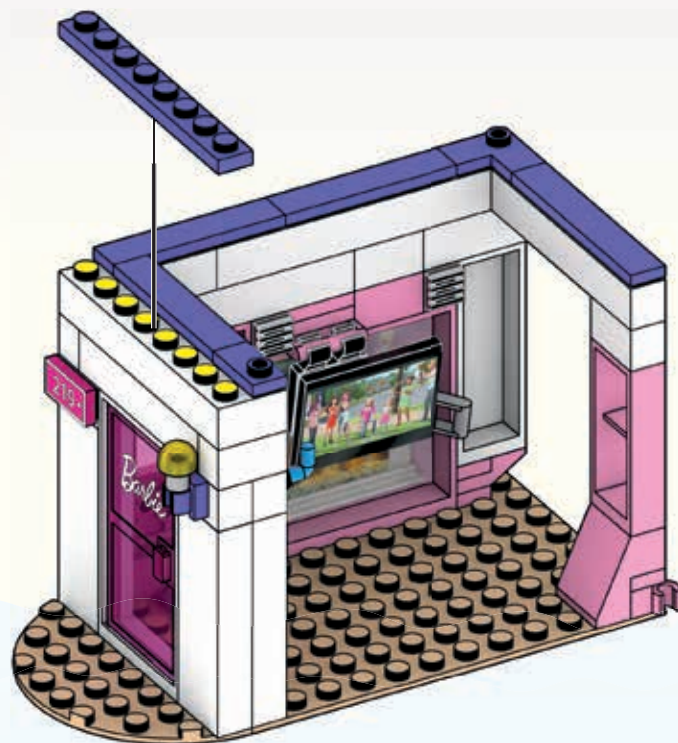

31





34

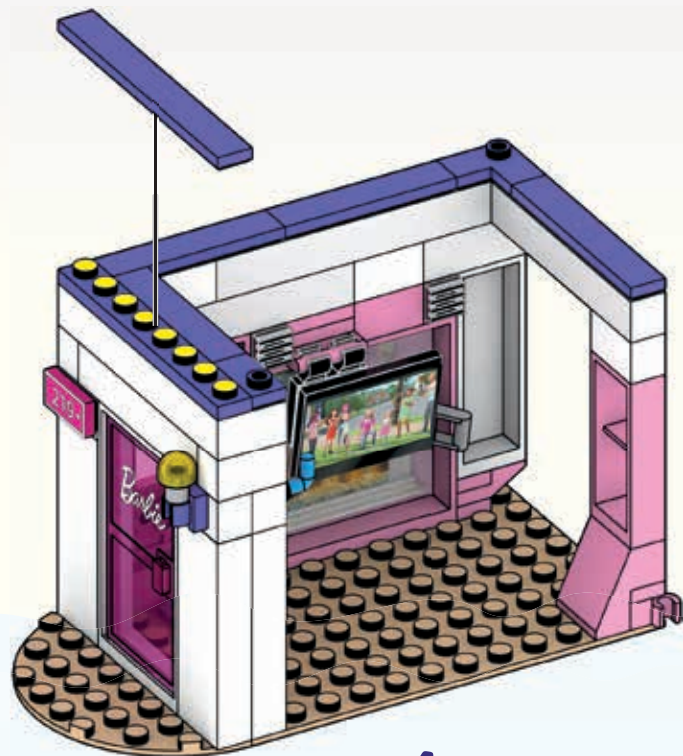

1

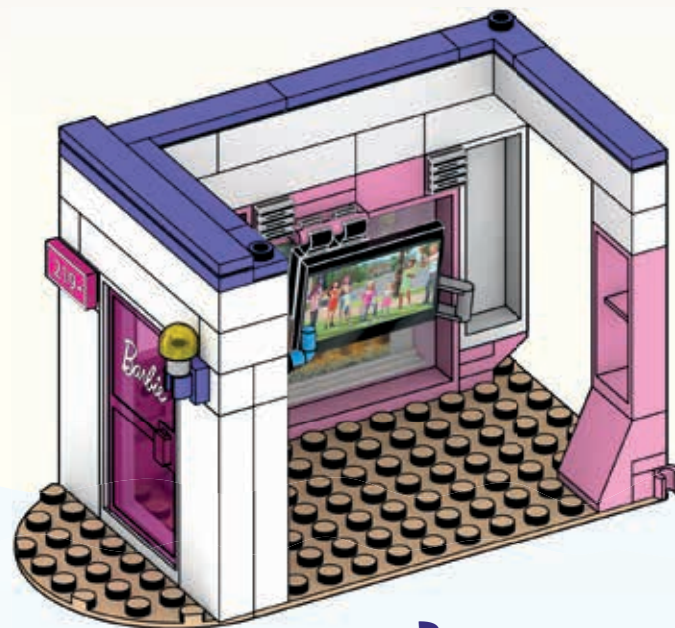

2





35

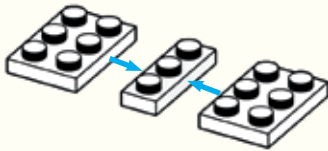

1

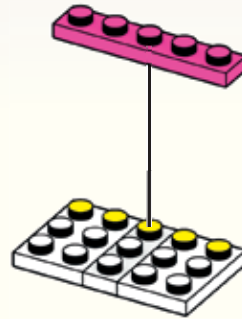

2



36

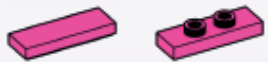

37

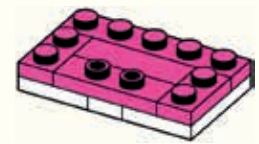
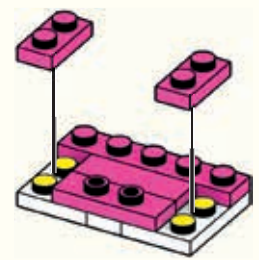
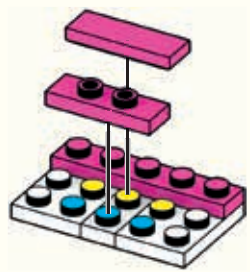
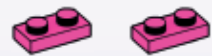

1

2

34





38



39

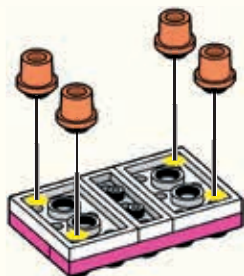
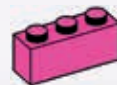

1

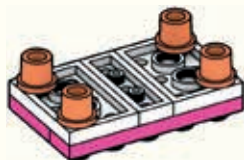

2

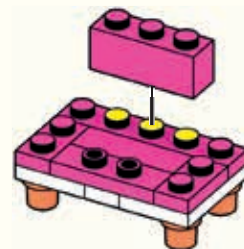



40

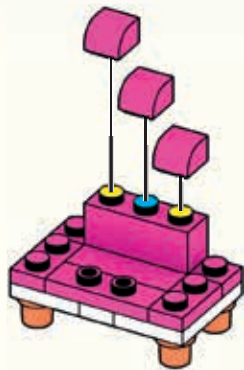

41

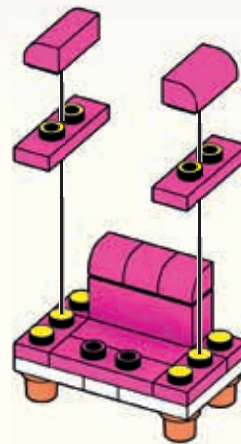

1



2





42

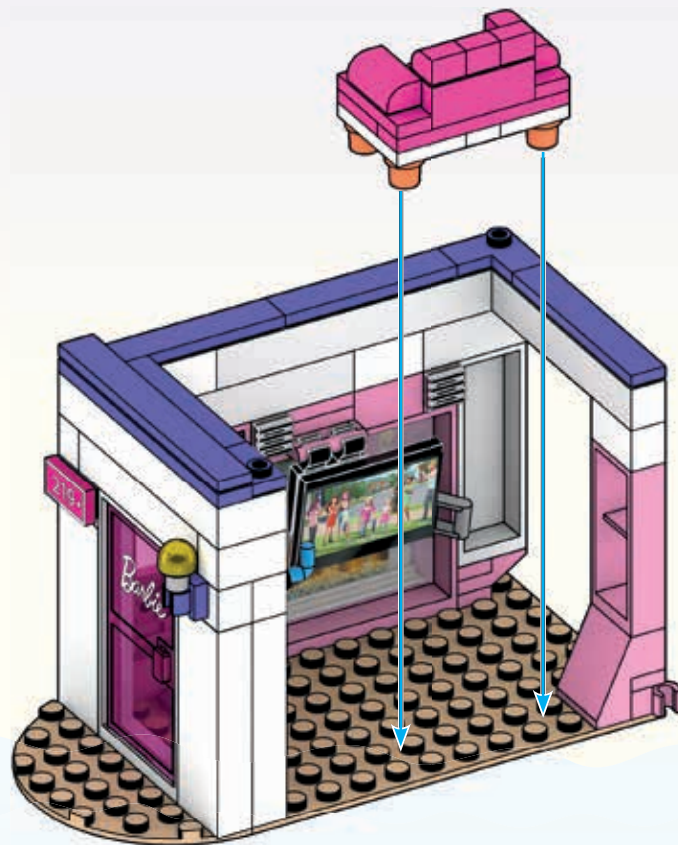

37





43

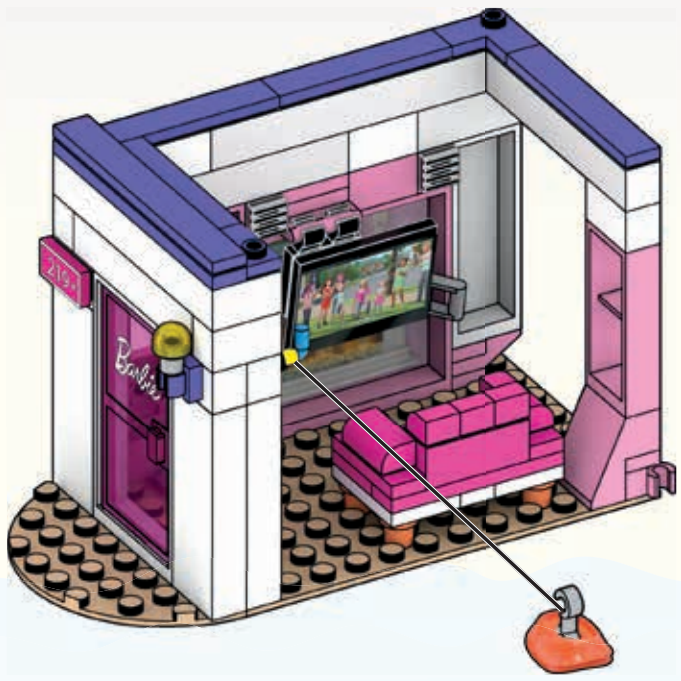
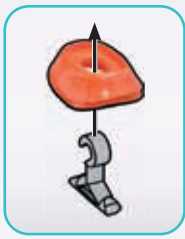

1

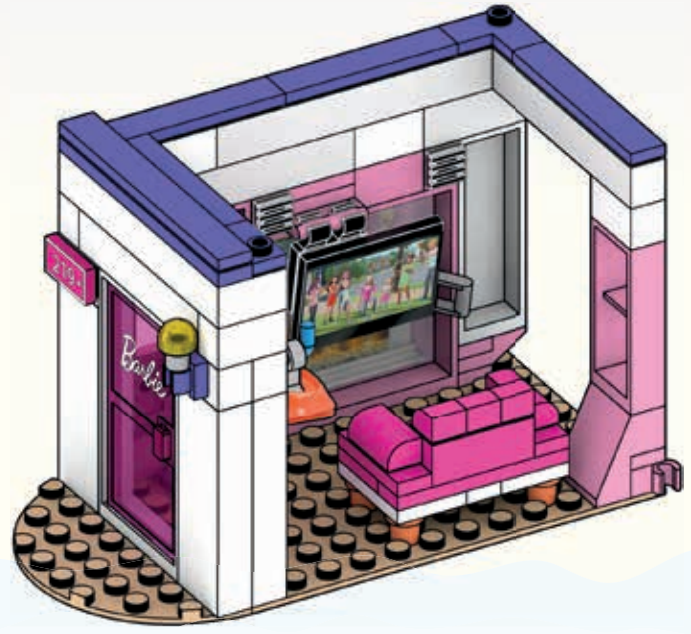

2



LET'S PLAY!
AMUSONS-NOUS!
¡AJUGAR! • A BRINGAR!
LASS UNS SPIELEN! • НАЧИНАЕМ ИГРУ!





Let's Build The Kitchen! Construisons la cuisine !

¡Vamos a construir la cocina!
Vamos construir a cozinha!
Die Küche bauen!
Построим кухню!

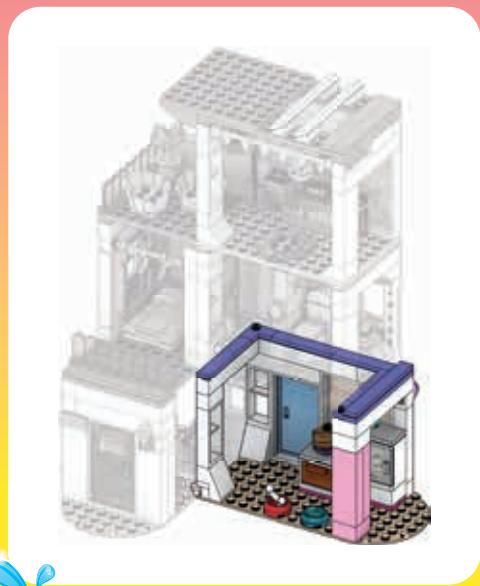

WHAT WILL YOU REVEAL? QU'ALLEZ-VOUS DÉCOUVRIR?

¿QUÉ VAS A REVELAR? • O QUE VOCÊ VAI REVELAR?
WELCHE PUPPE KOMMT ZUM VORSCHEN?
КАКУЮ КУКЛУ ВЫ ОТКРОЕТЕ?



CUSTOMIZE YOUR BARBIE® MICRO-DOLL! PERSONNALISEZ VOTRE MICRO-POUPÉE BARBIE®!

¡PERSONALIZA TU MICROMUÑECA BARBIE®! • PERSONALIZE A SUA MICROBONECA BARBIE®!
DIE BARBIE MIKROPUPPE LÄSST SICH IMMER WIEDER NEU GESTALTEN! • СОЗДАЙТЕ СВОЮ МИКРОКУКЛУ BARBIE®!

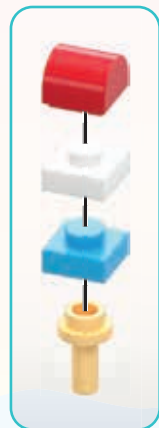

1



2

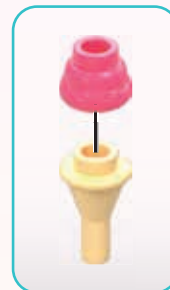

1



2



44

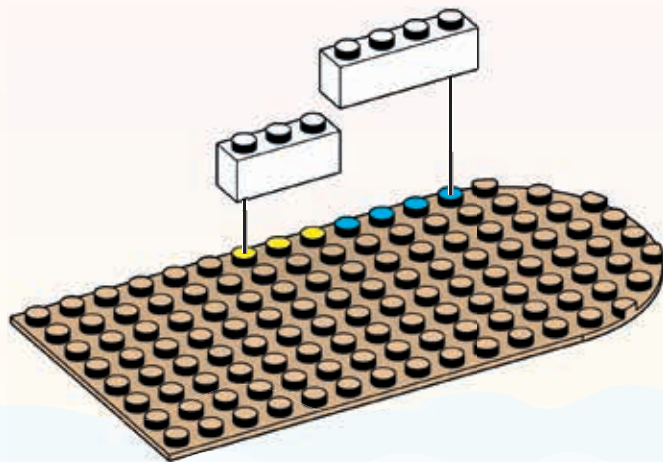
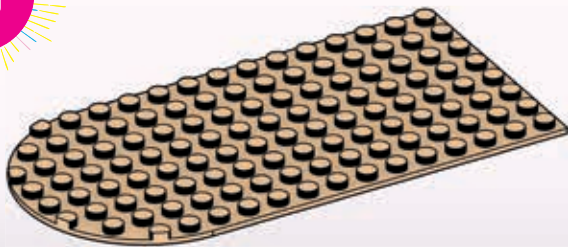

45

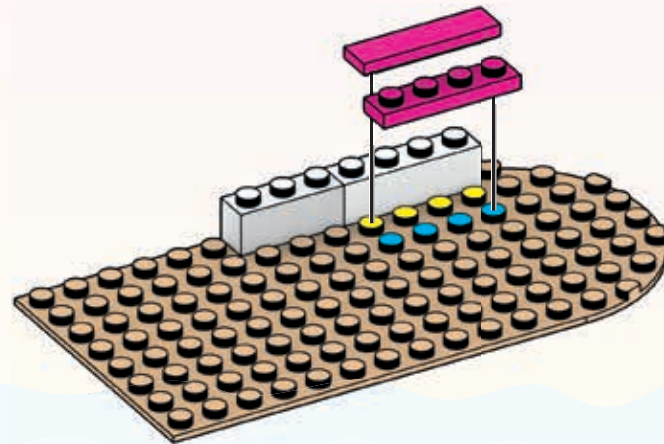

42



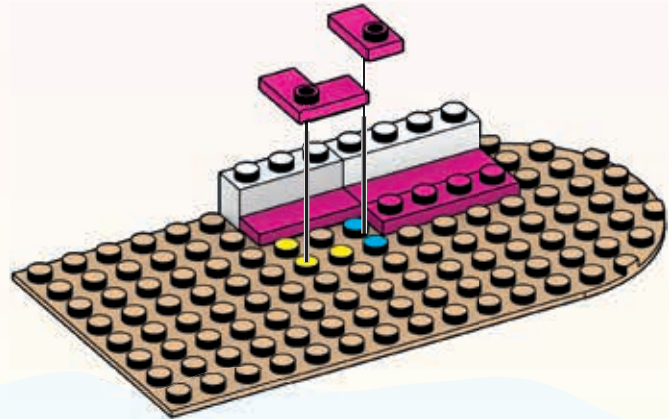
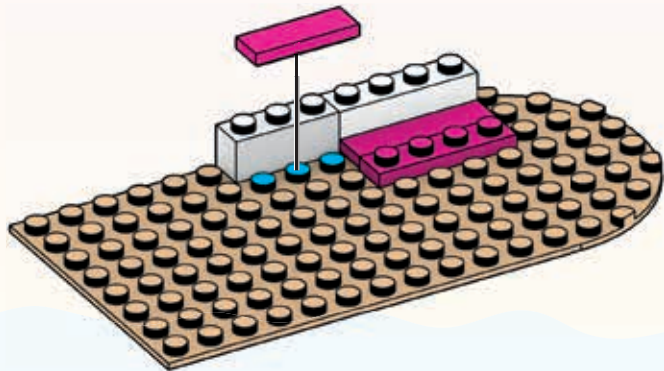
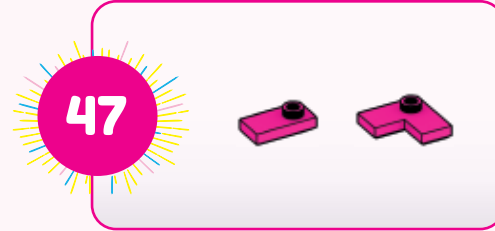
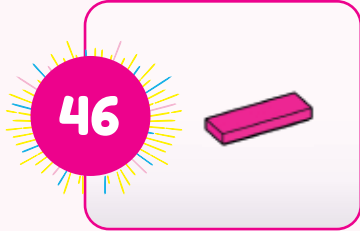



48

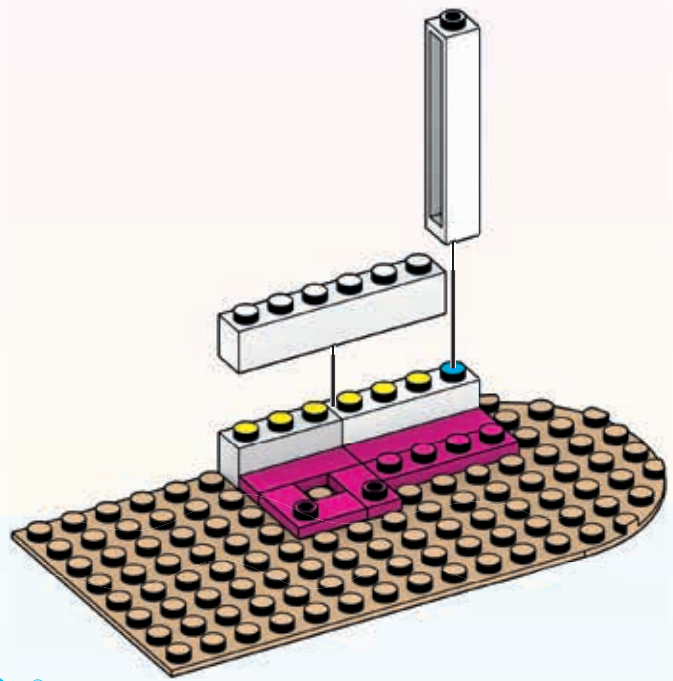
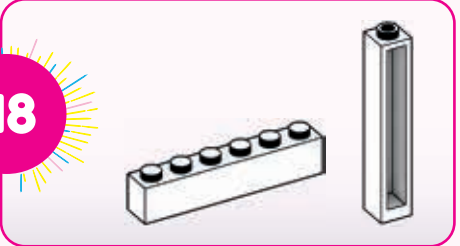

49

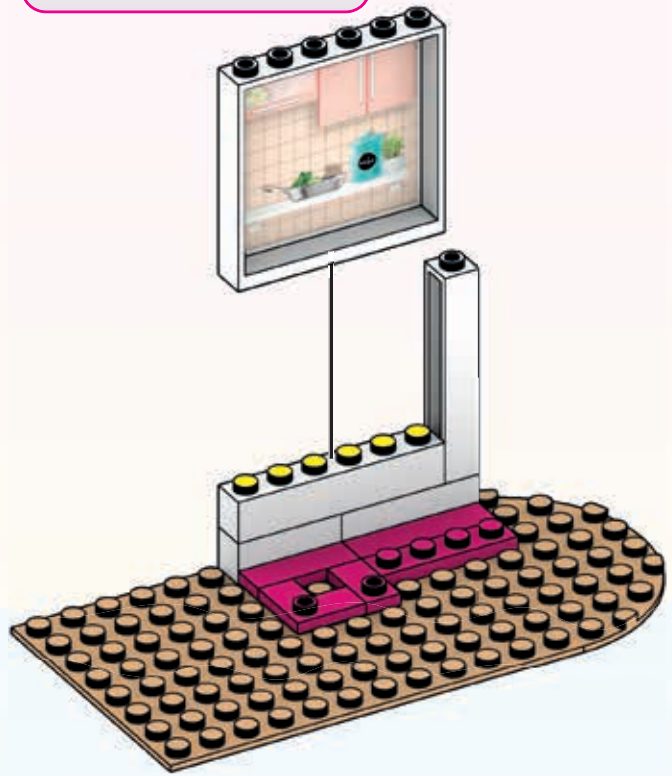

44





50

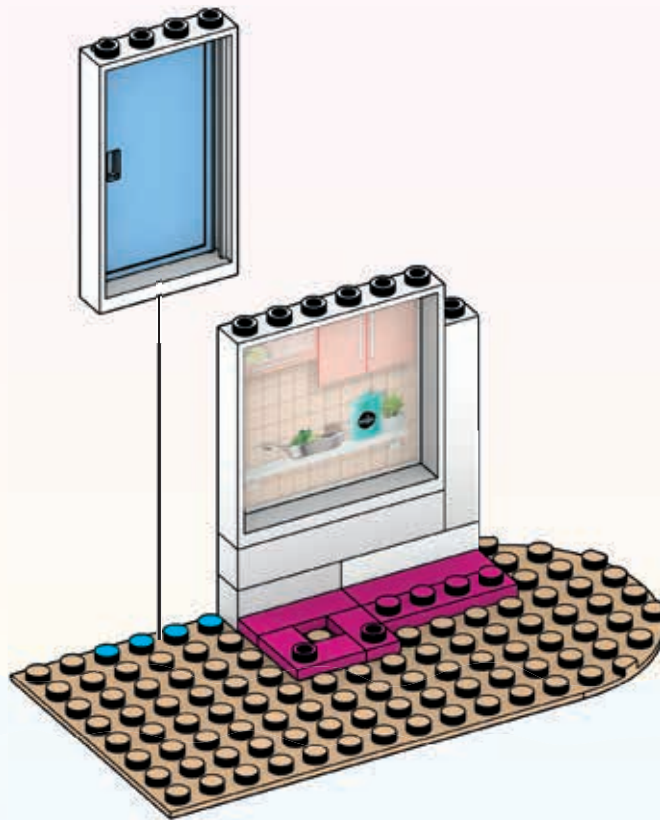
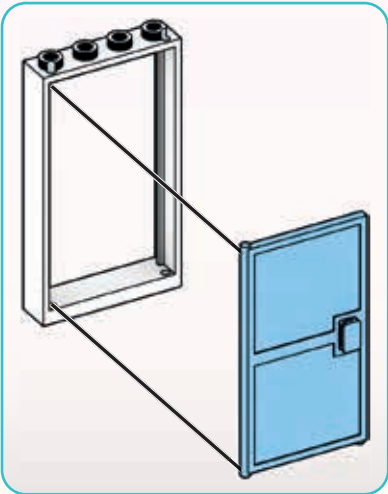
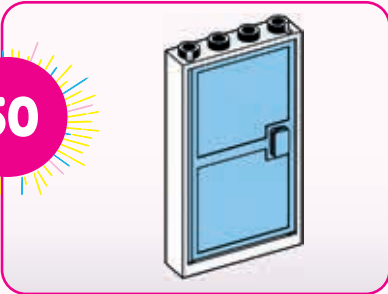

45

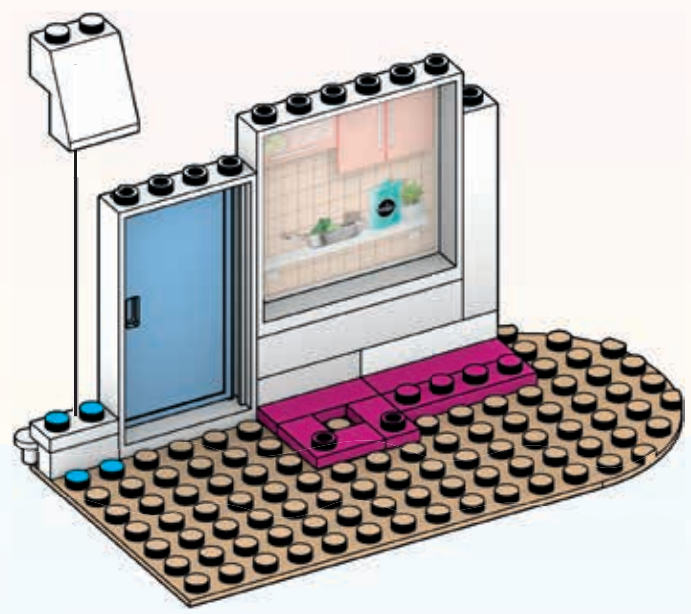
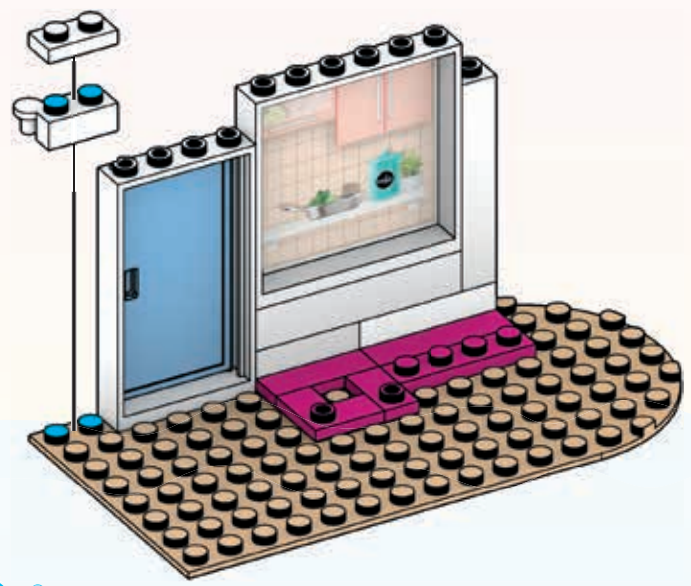
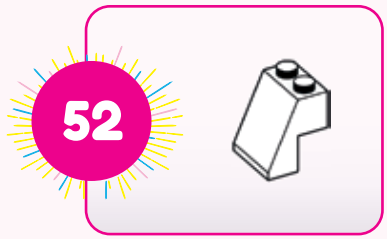
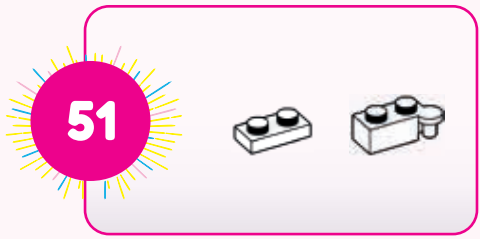

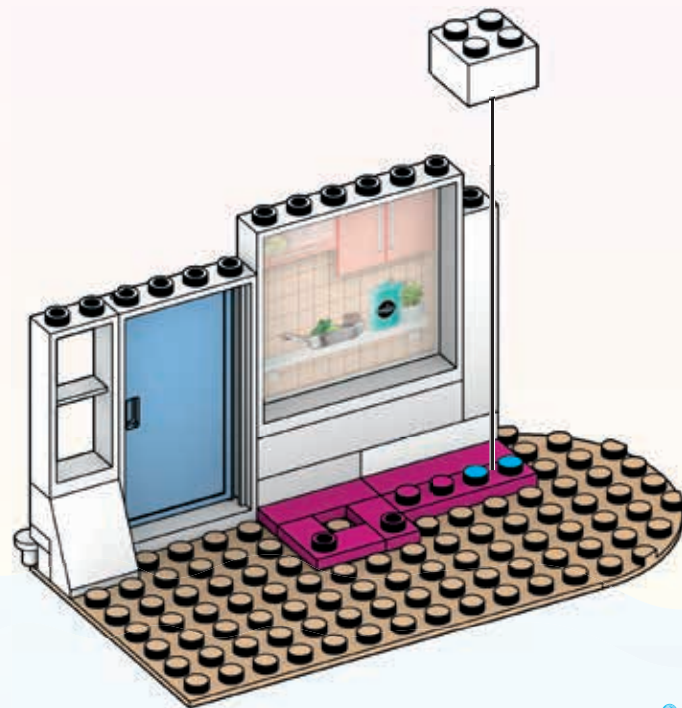
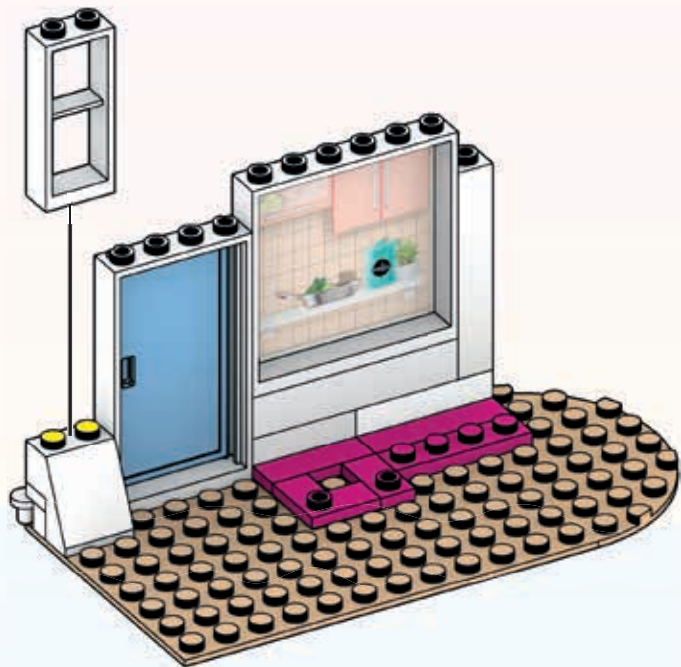
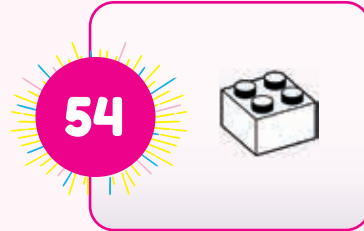
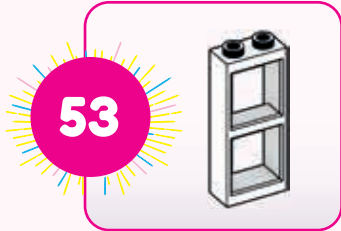



55

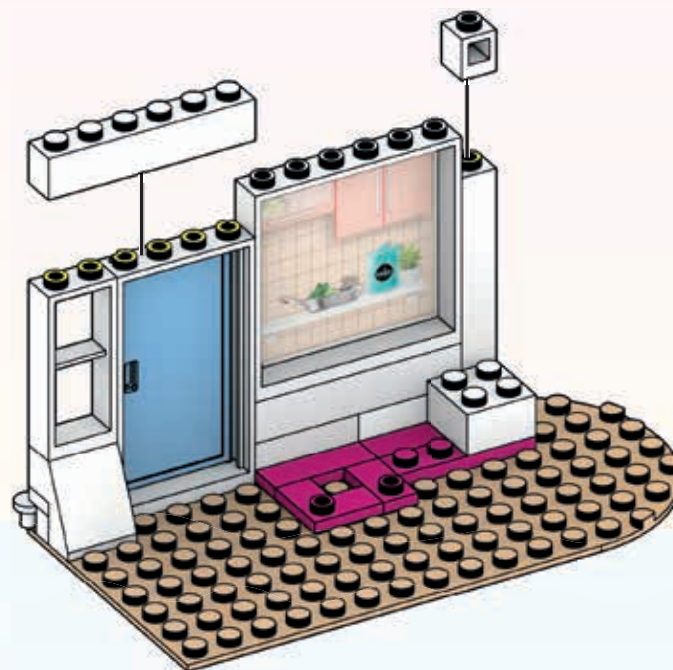

48





56

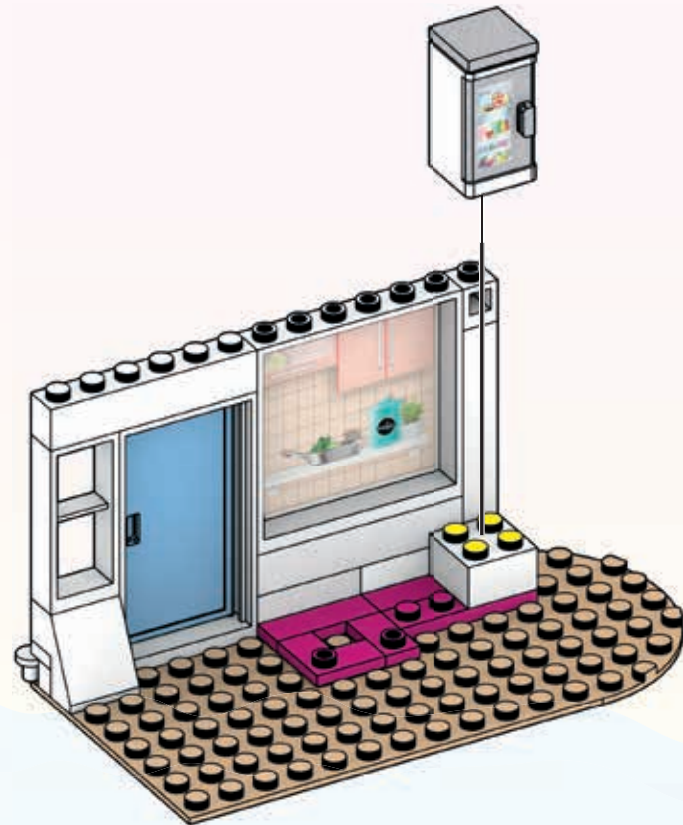
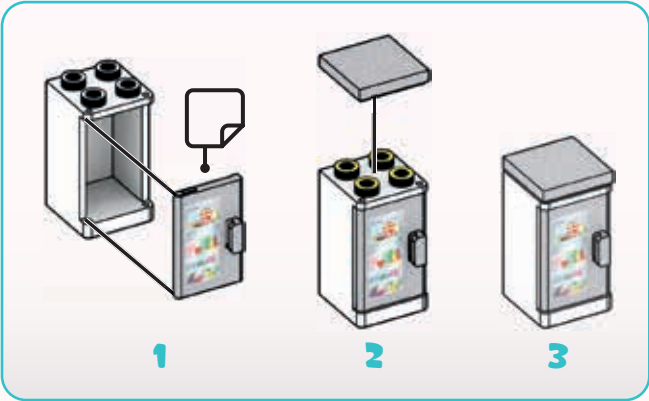
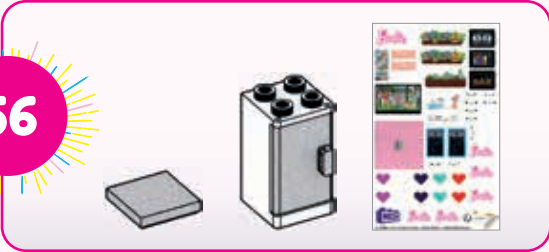

49



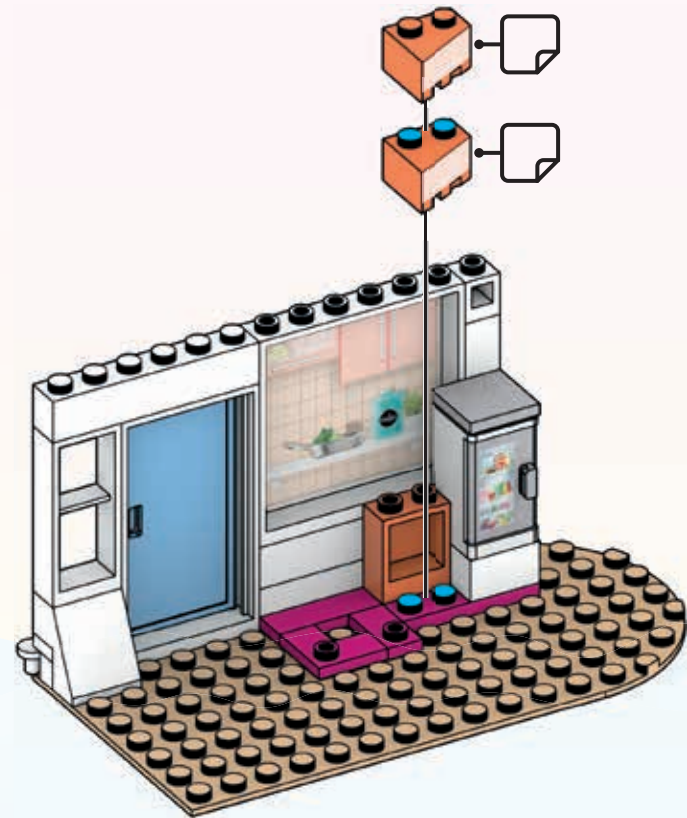
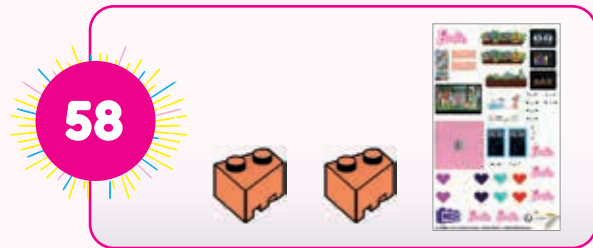
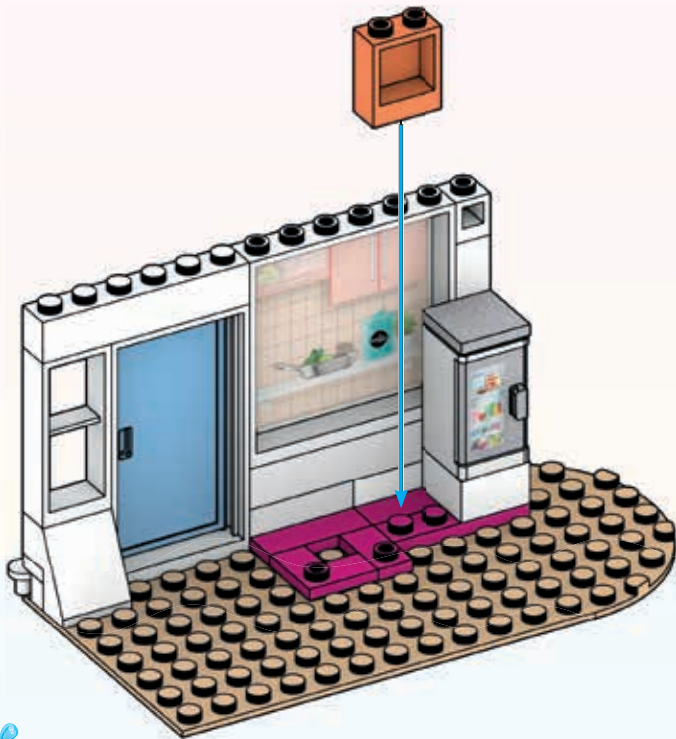

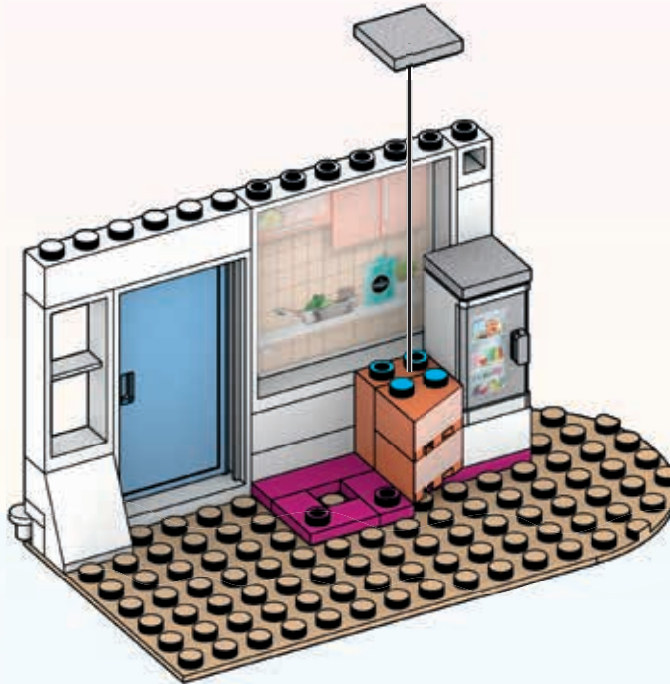
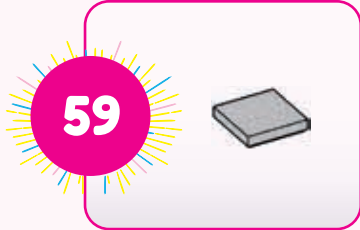



60

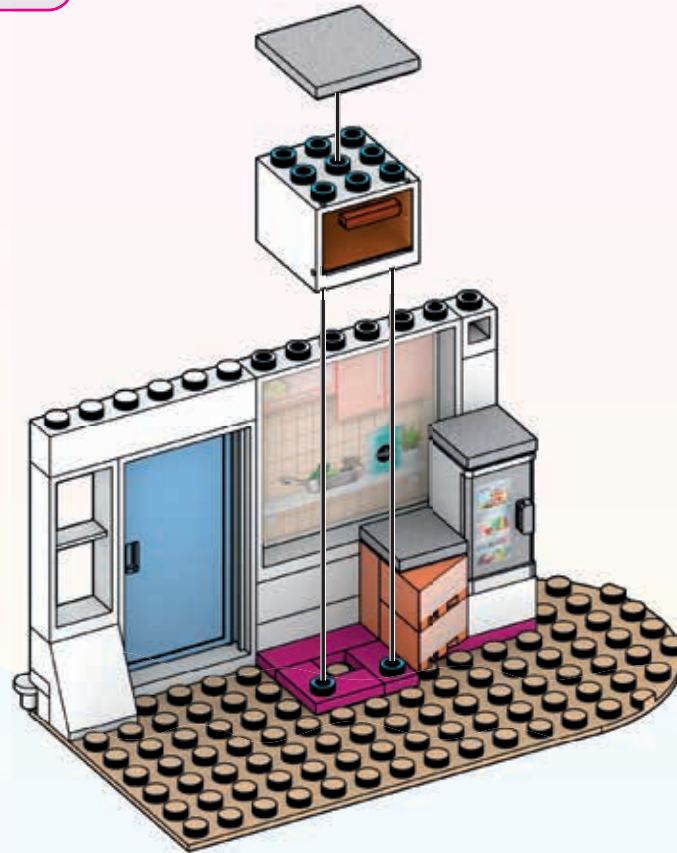
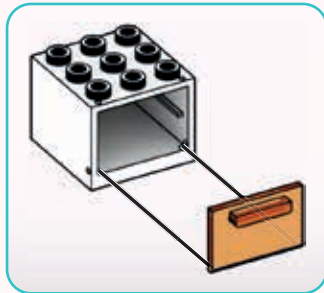
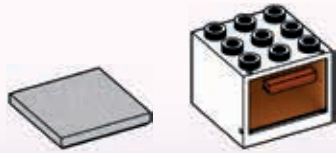

52

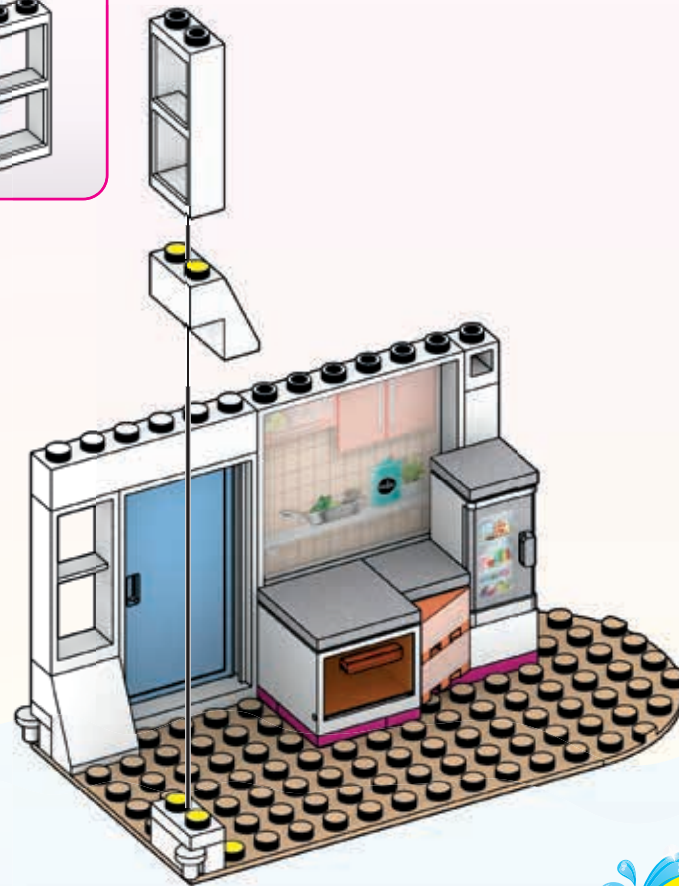
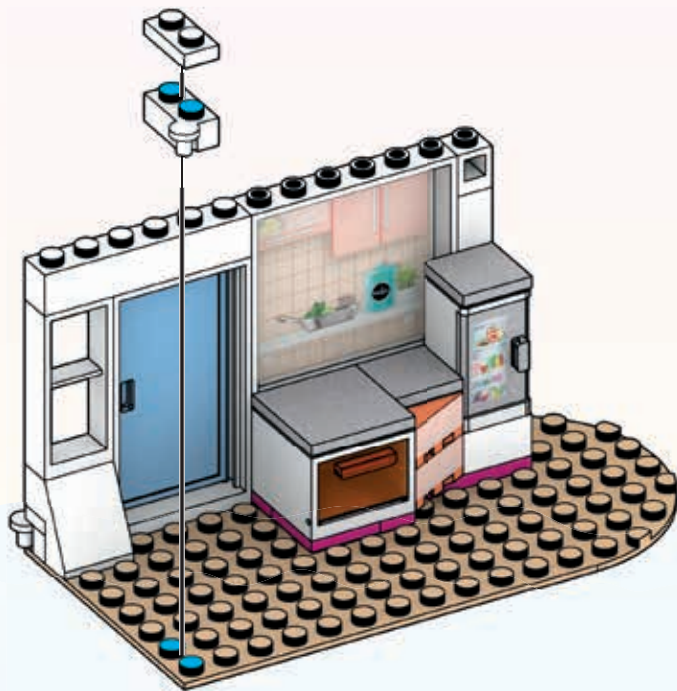
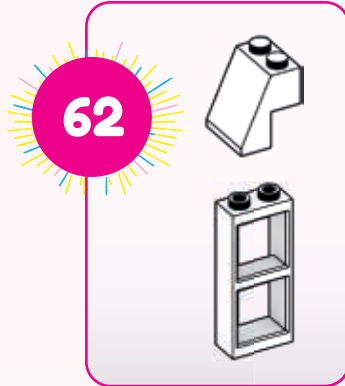
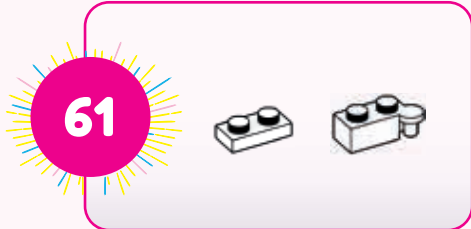

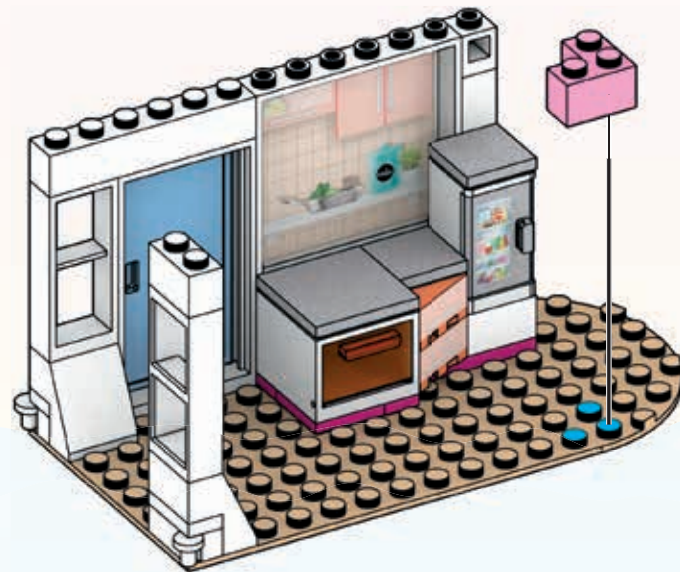
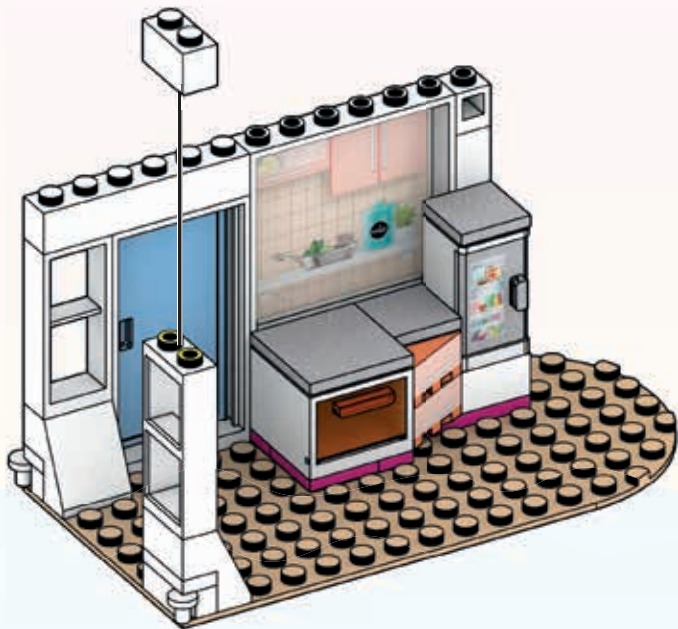
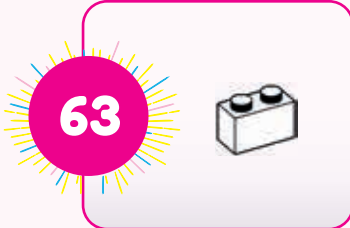

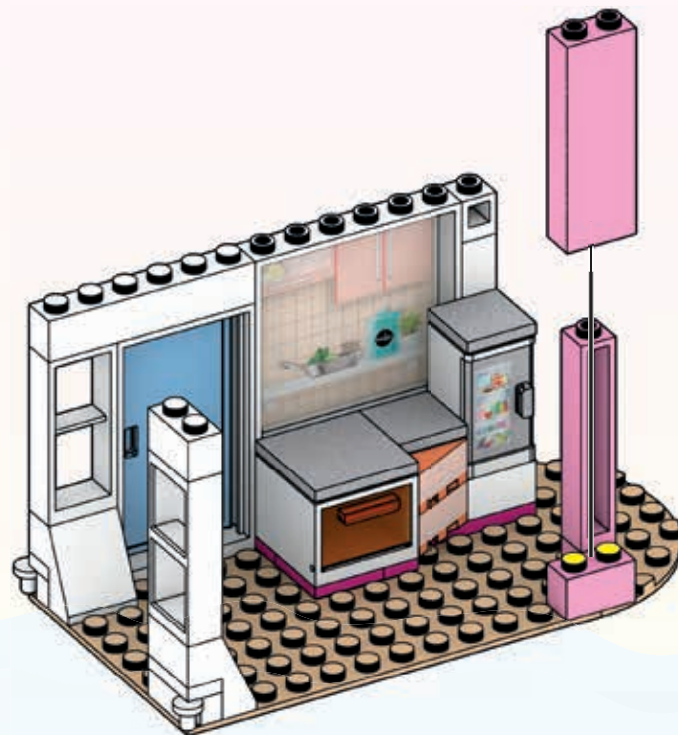
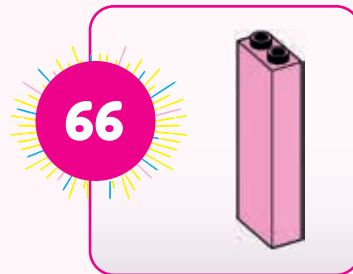
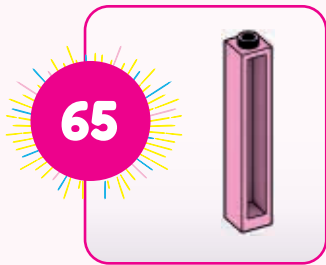



67

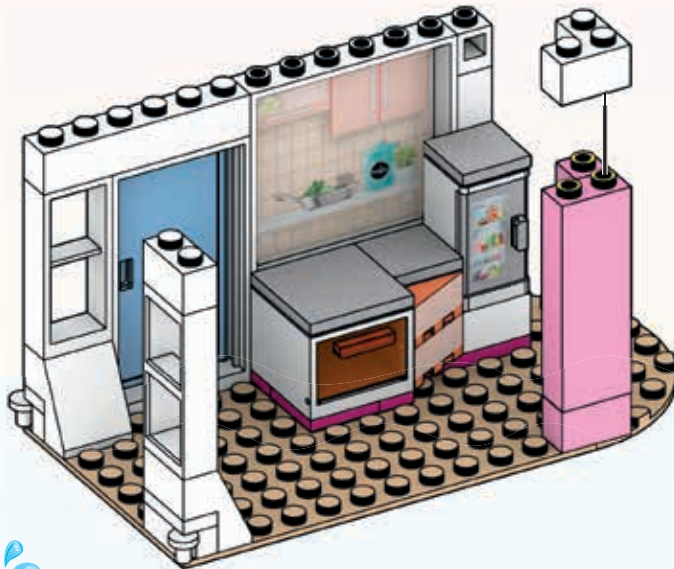

68

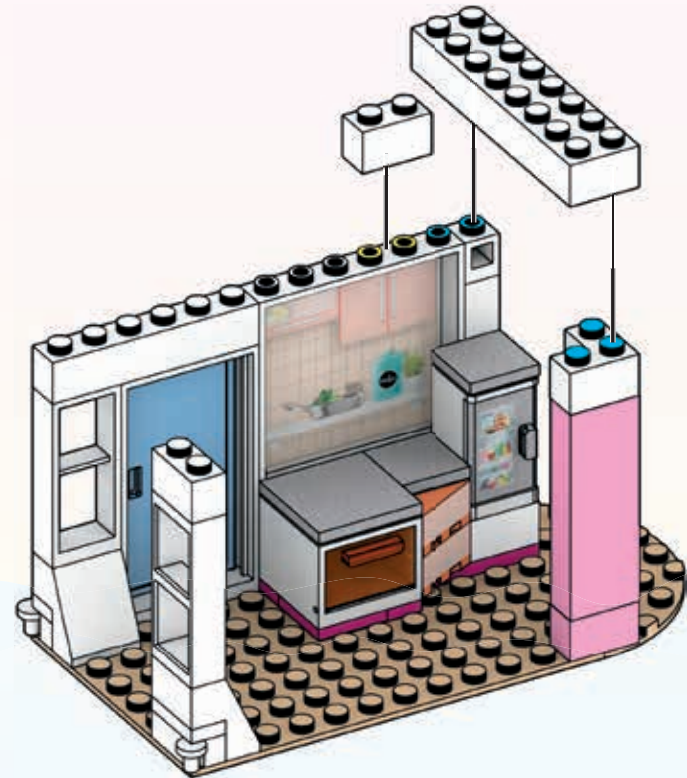

56





69

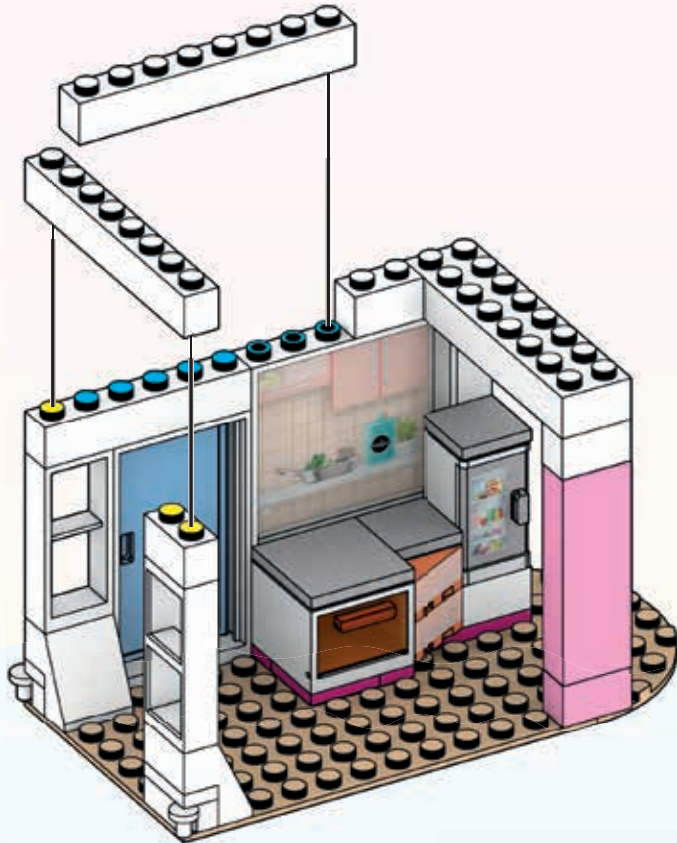
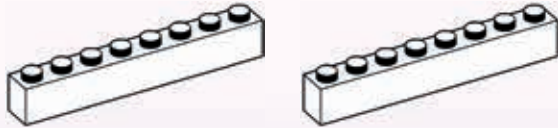

70

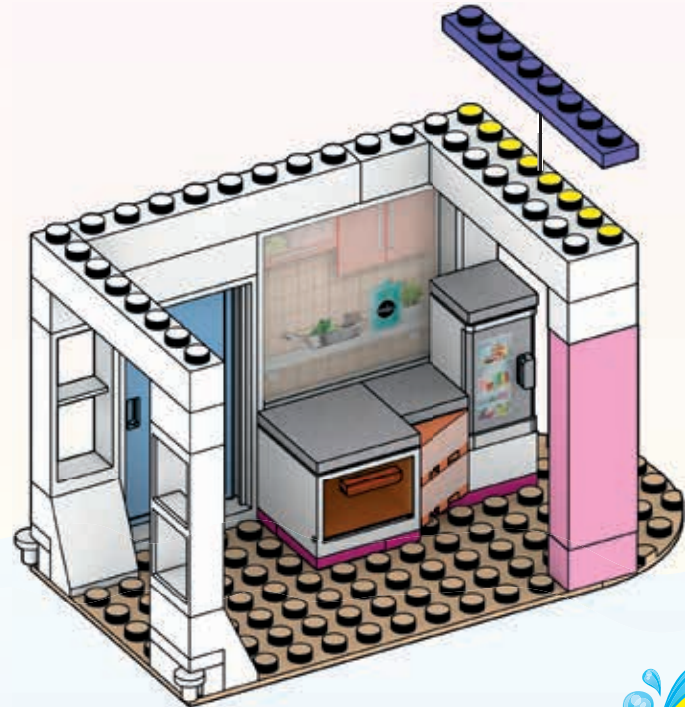
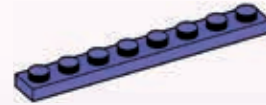

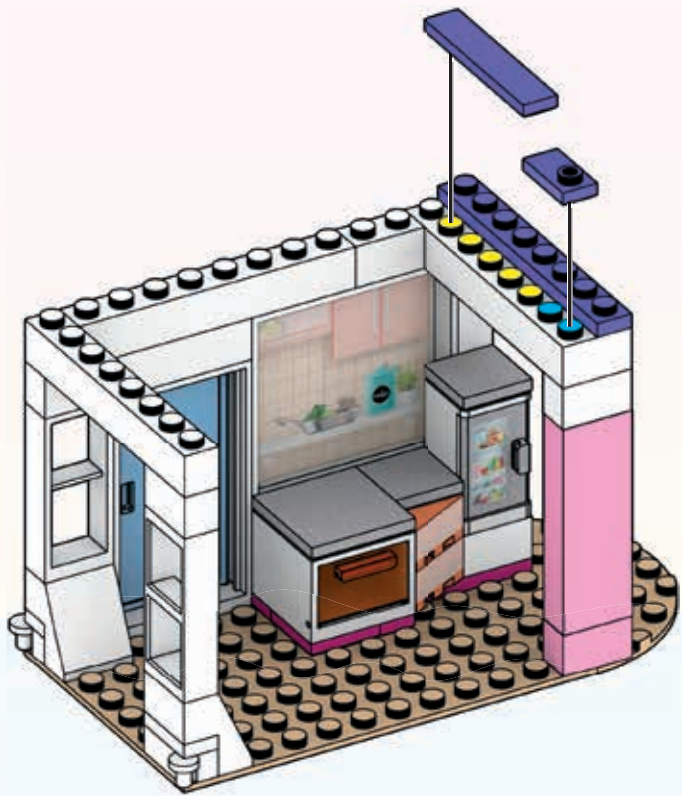
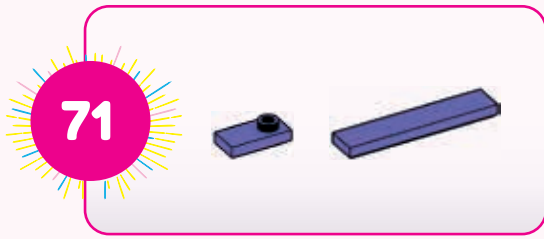



72

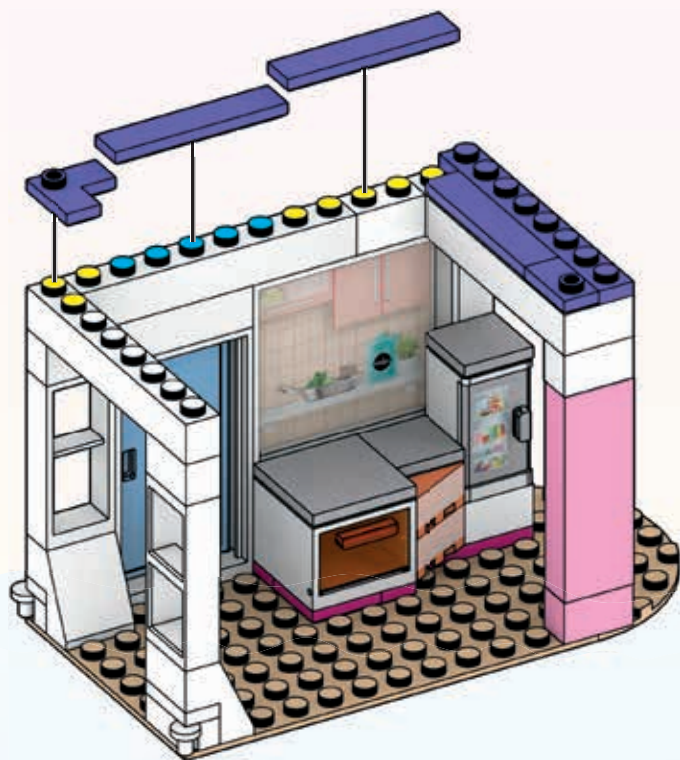

73

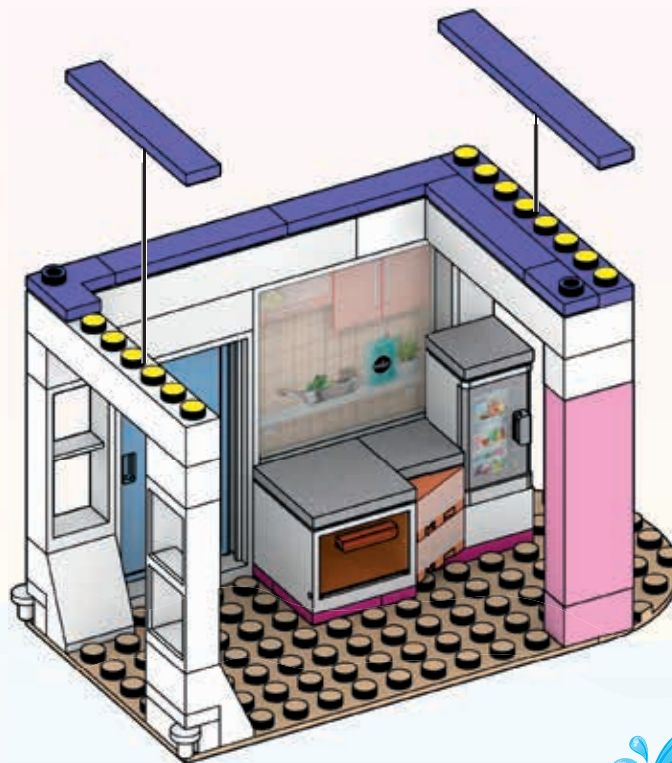

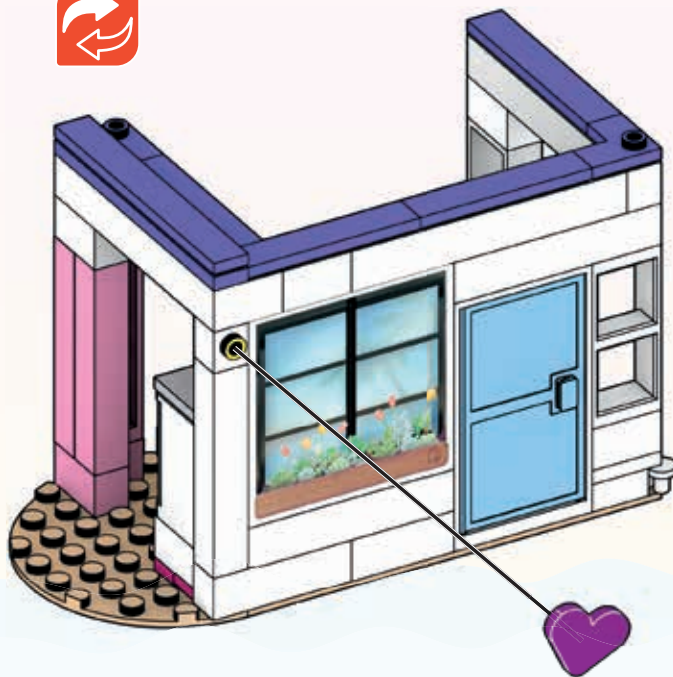

1



2



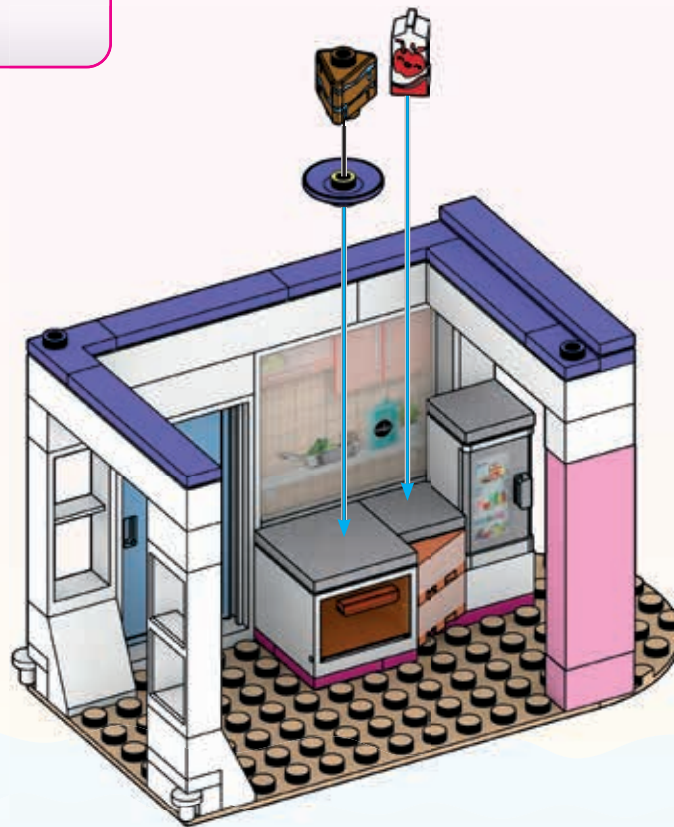
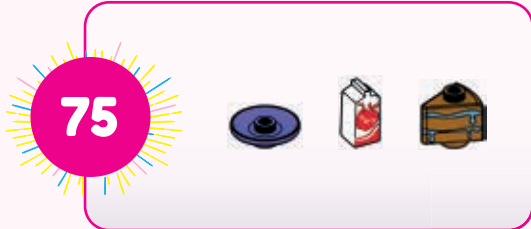



76



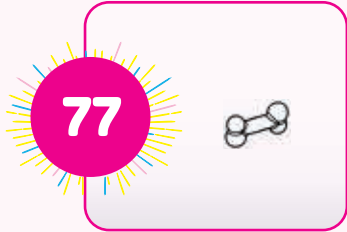

1



2





78



1



2

64

LET'S PLAY!
AMUSONS-NOUS!
¡AJUGAR! • A BRINGAR!
LASS UNS SPIELEN! • НАЧИНАЕМ ИГРУ!





Let's Build The Bedroom! Construons la chambre !

¡Vamos a construir el dormitorio!
Vamos construir o quarto!
Das Schlafzimmer bauen!
Построим спальню!



WHAT WILL YOU REVEAL? QU'ALLEZ-VOUS DÉCOUVRIR?

¿QUÉ VAS A REVELAR? • O QUE VOCÊ VAI REVELAR?
WELCHE PUPPE KOMMT ZUM VORSCHN?
КАКУЮ КУКЛУ ВЫ ОТКРОЕТЕ?





79

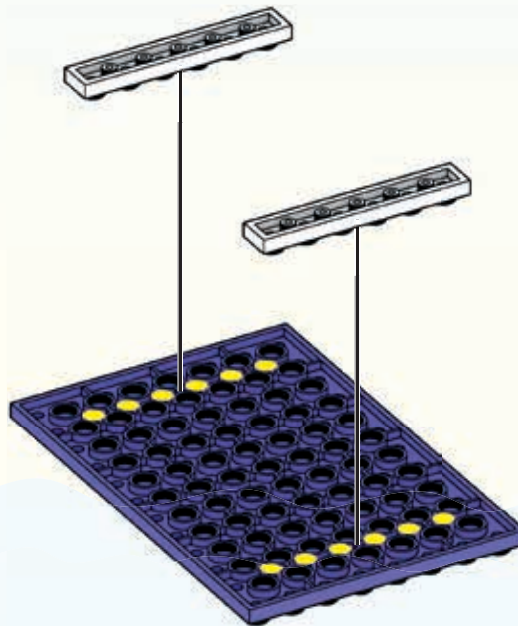
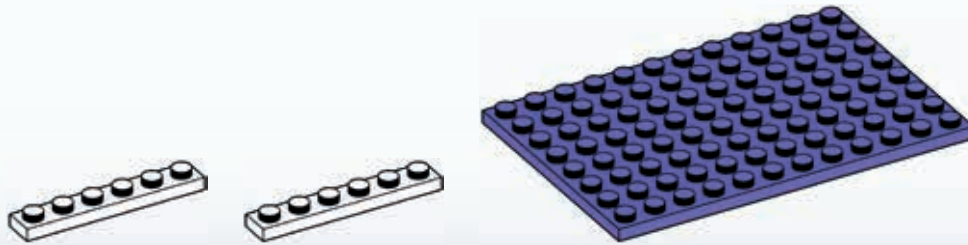

67





80

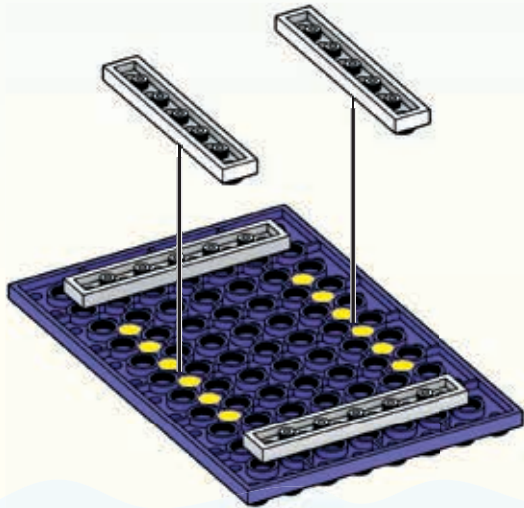

1

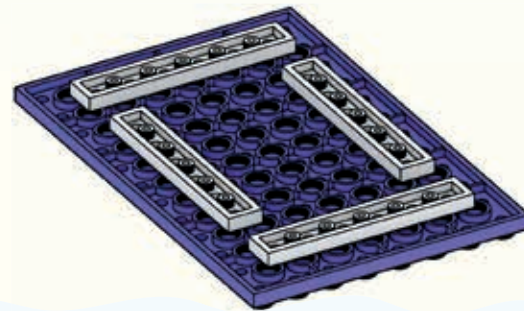

2



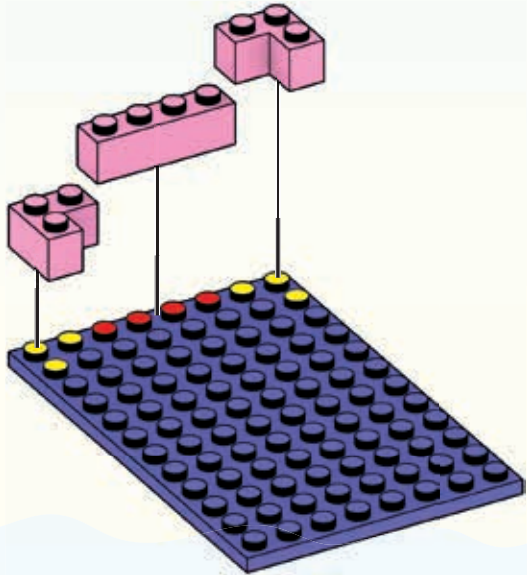
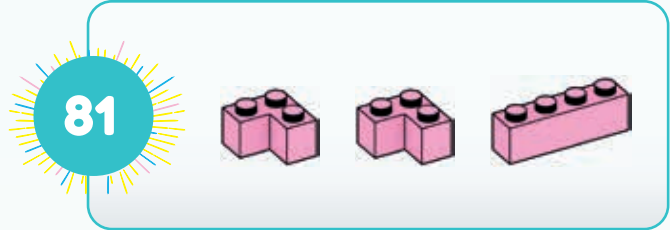



82



70

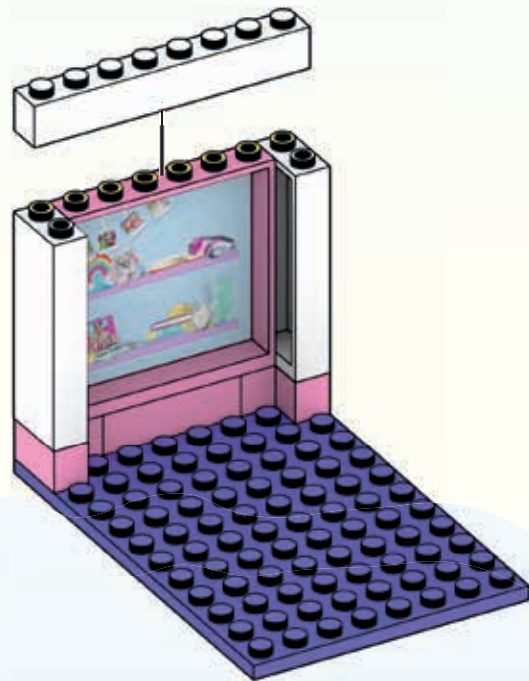
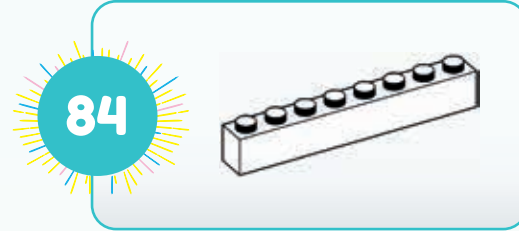
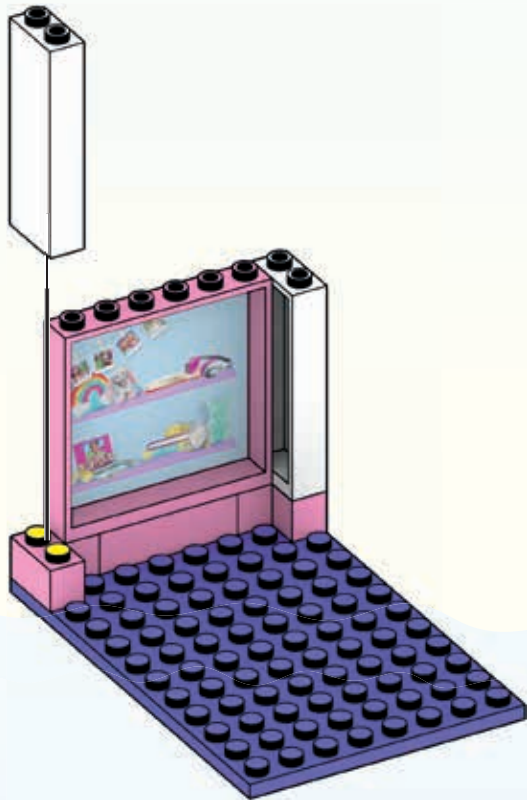



85

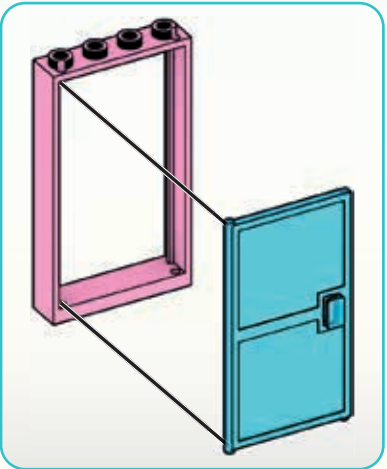
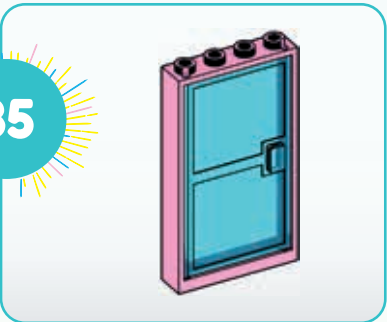

72





86

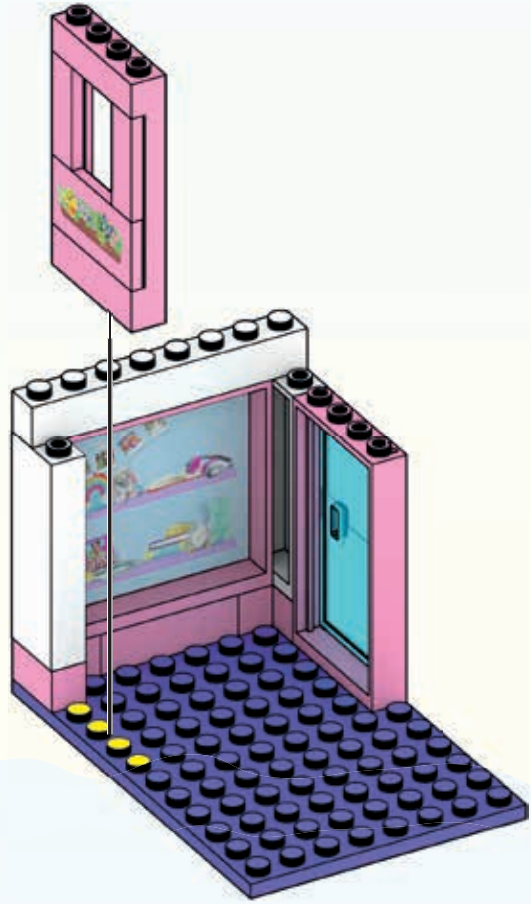
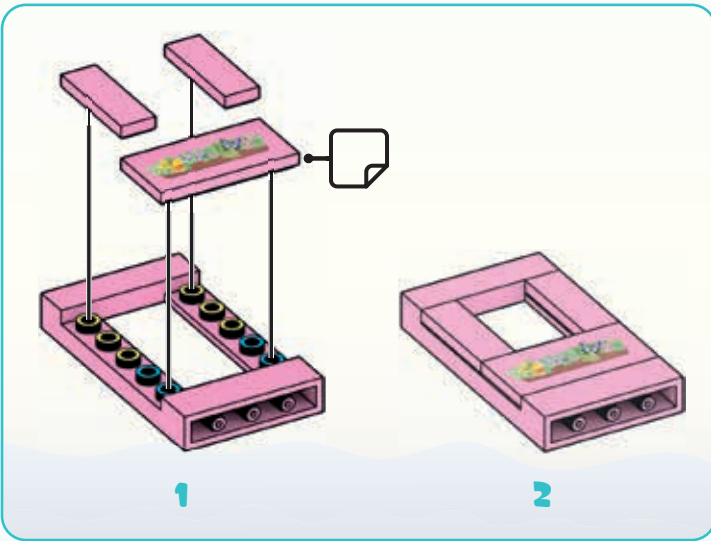
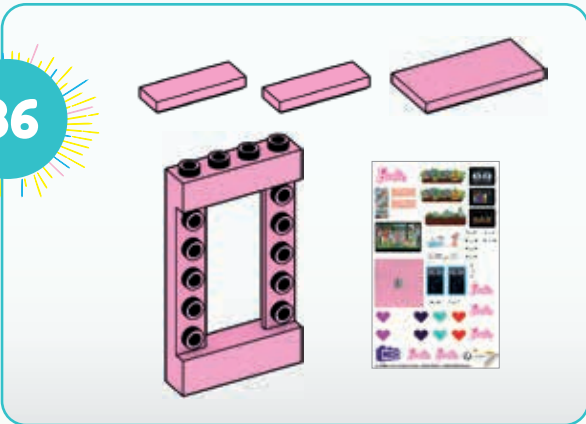

73





87



88

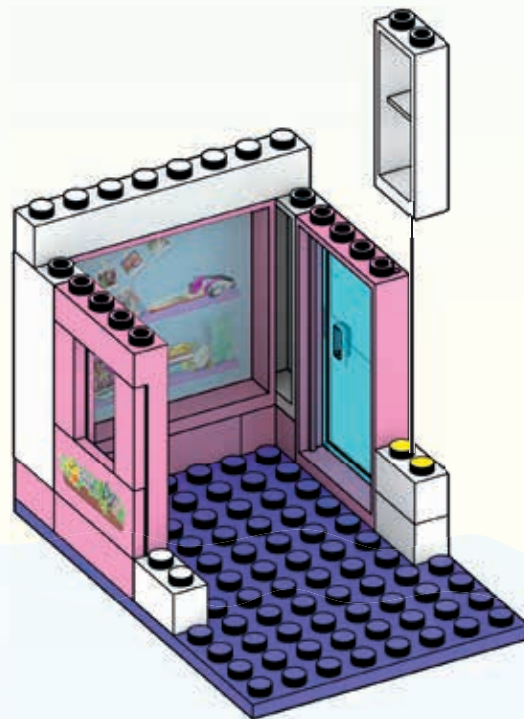
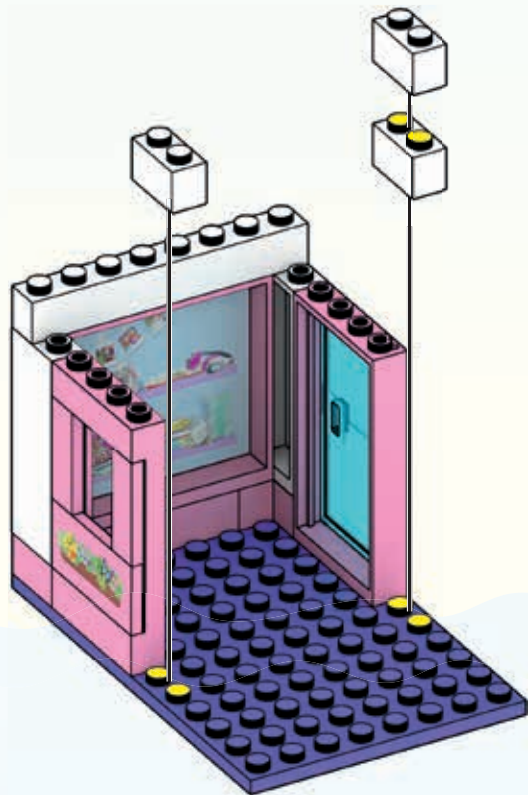

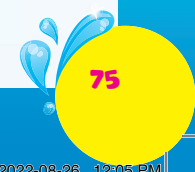
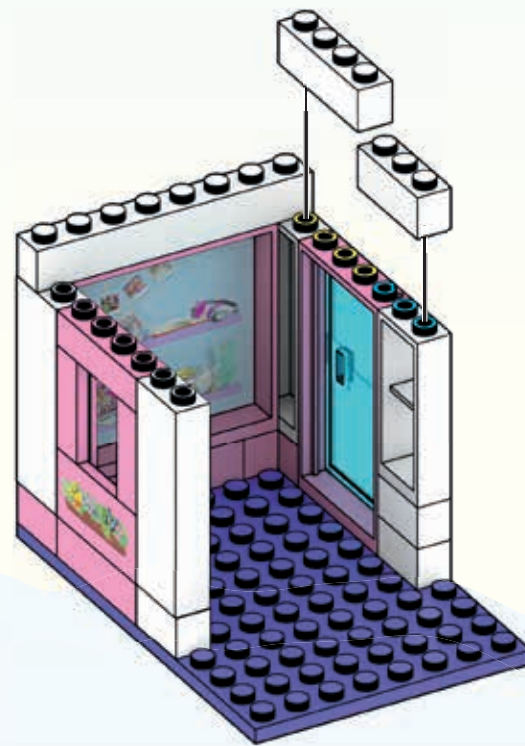
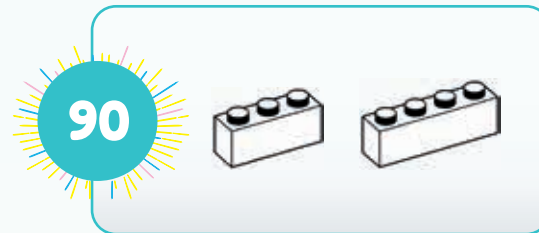
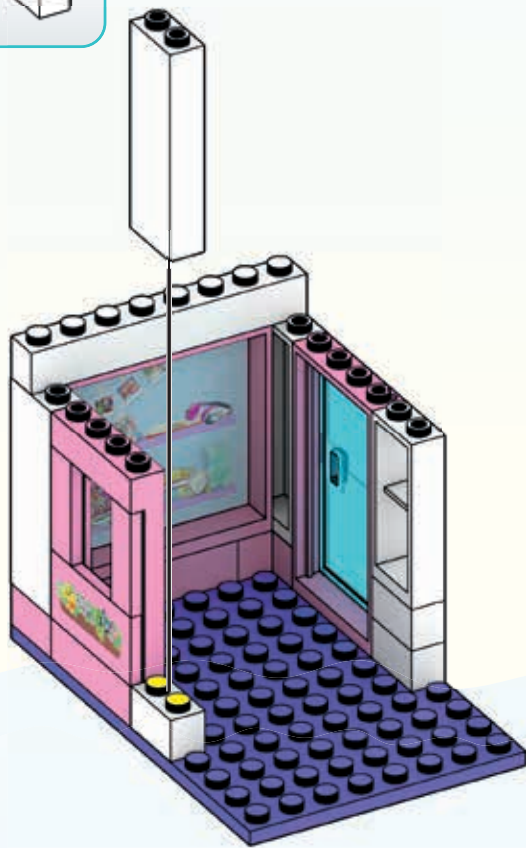



91



92

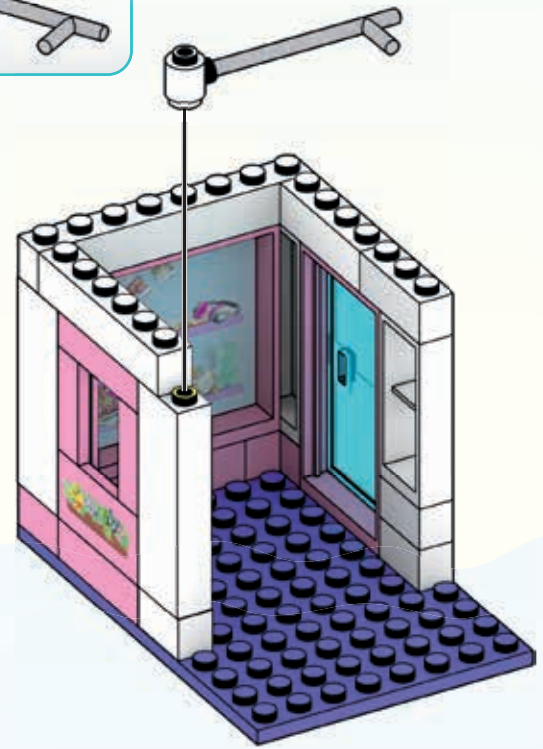
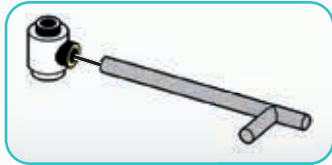



93

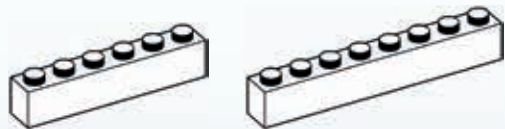

94

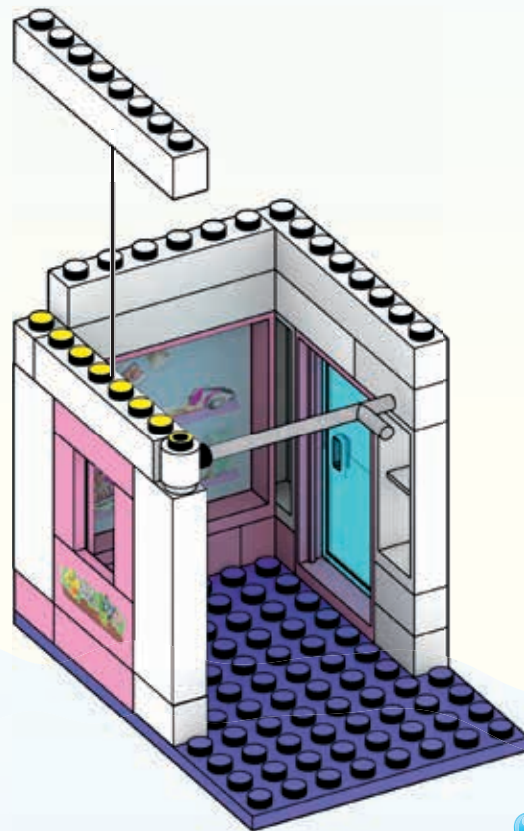
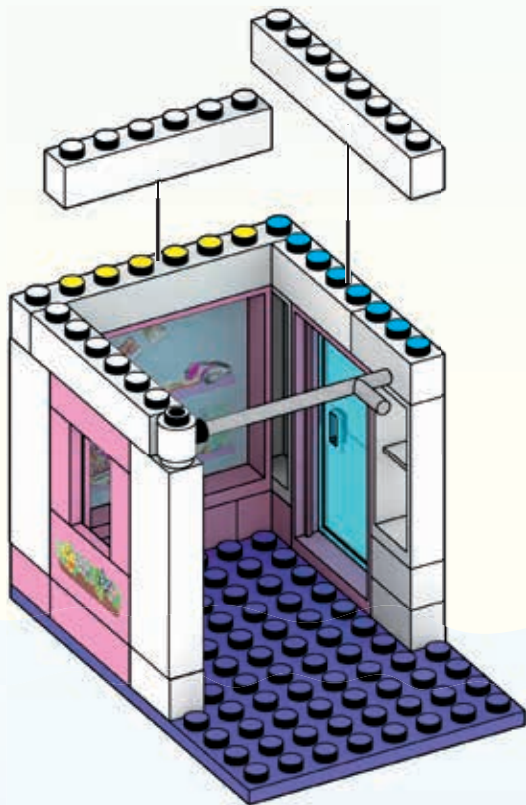
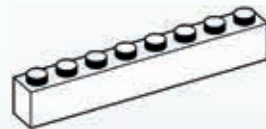

77





95

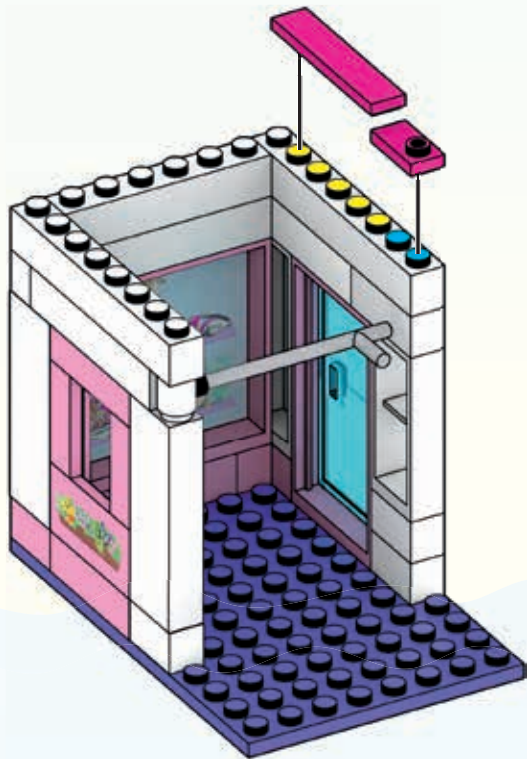

96

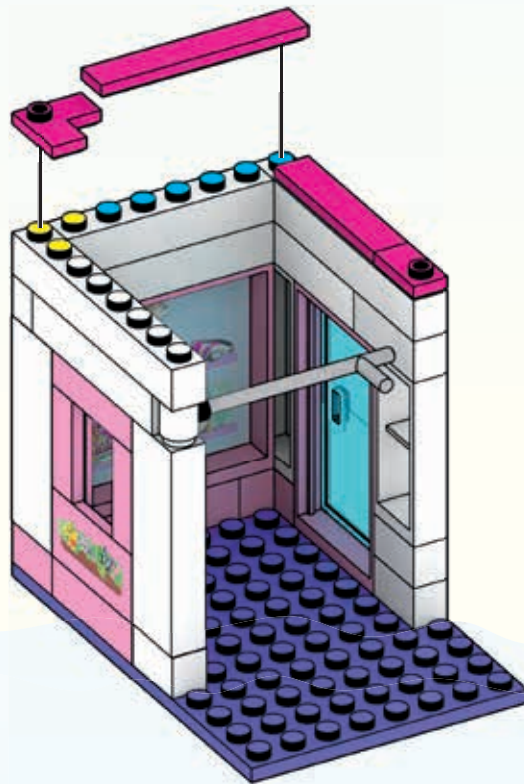

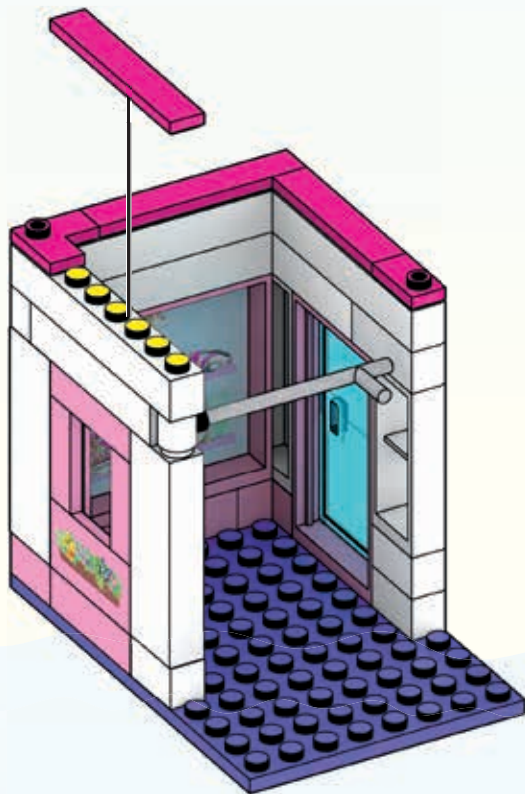
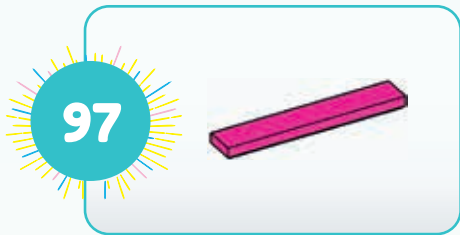

1

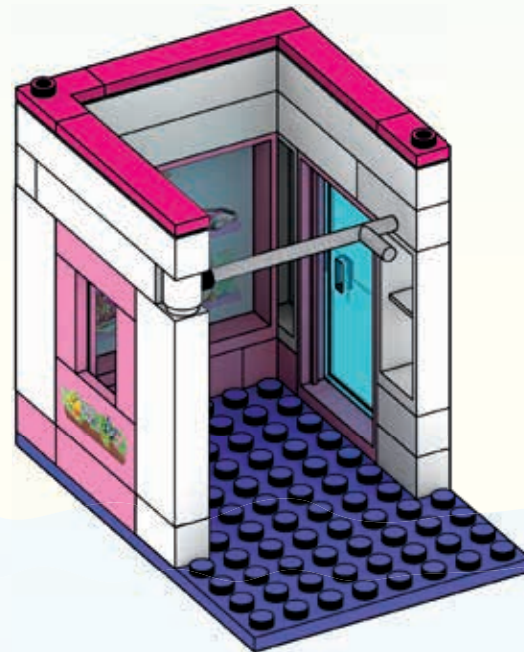

2





98

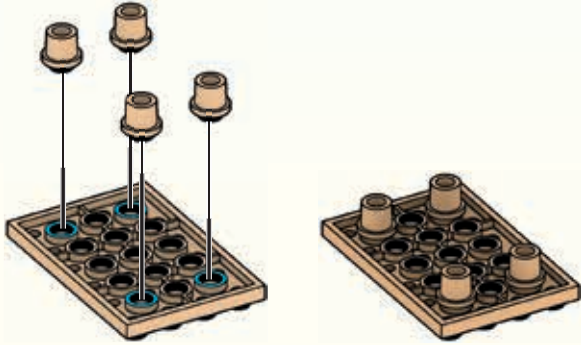
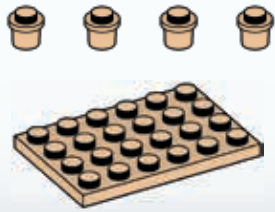

1

2

99

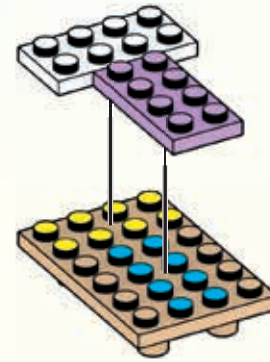

80





100

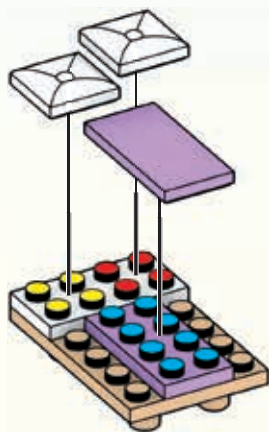

101

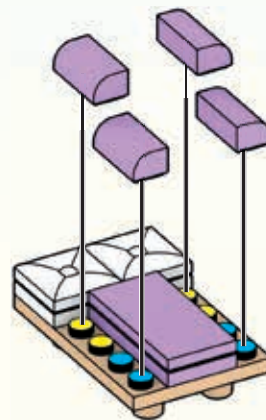

1

2





102

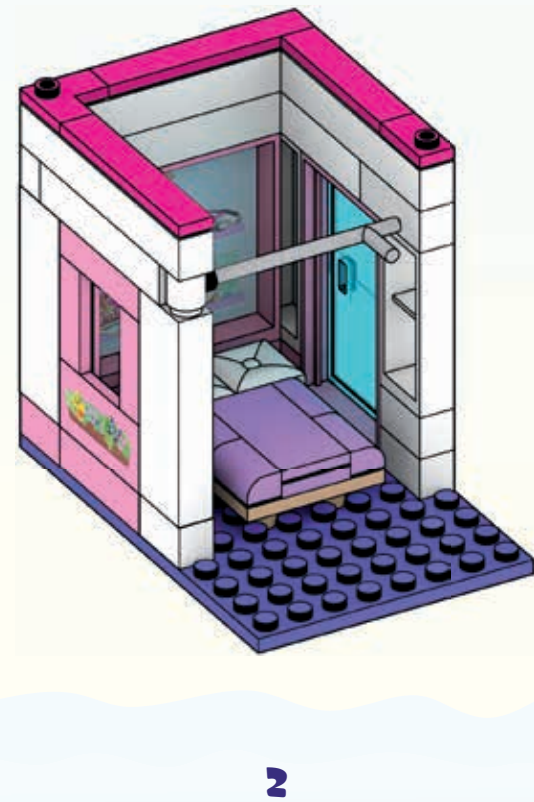
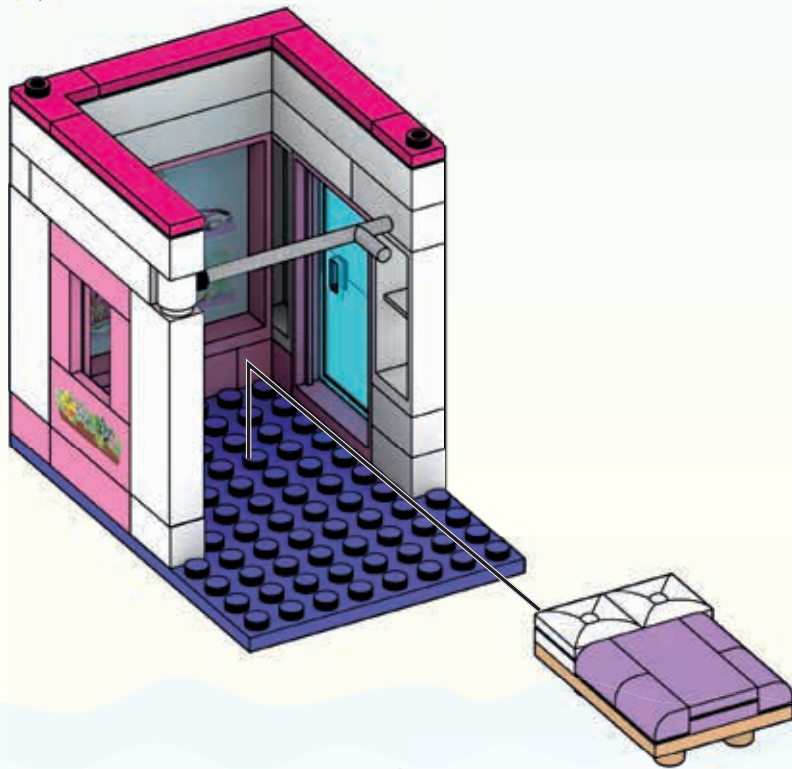

82





103

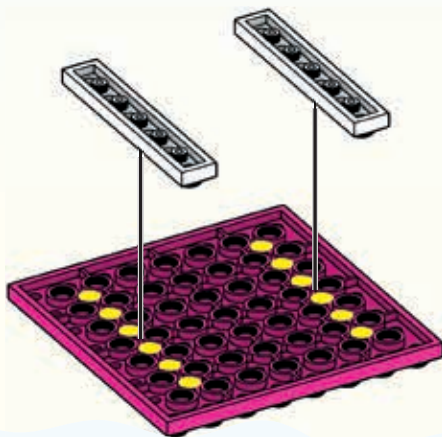
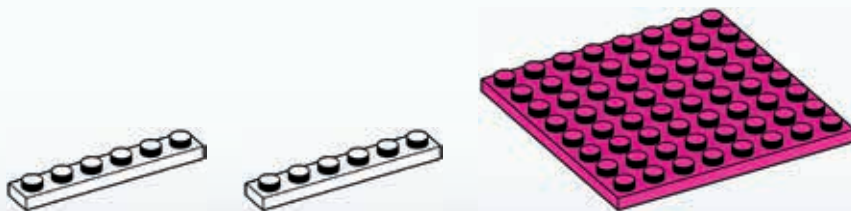

1



2





104

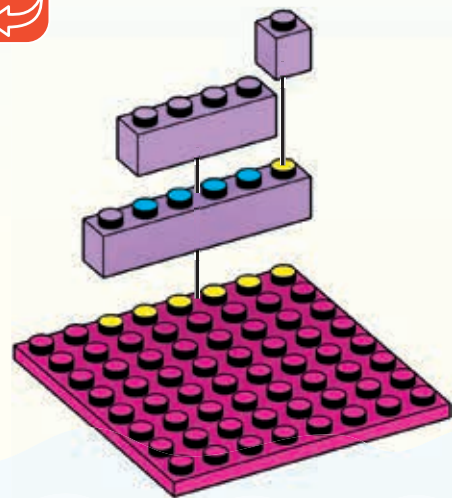
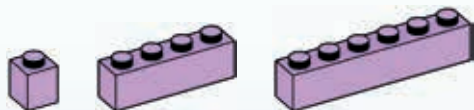

105

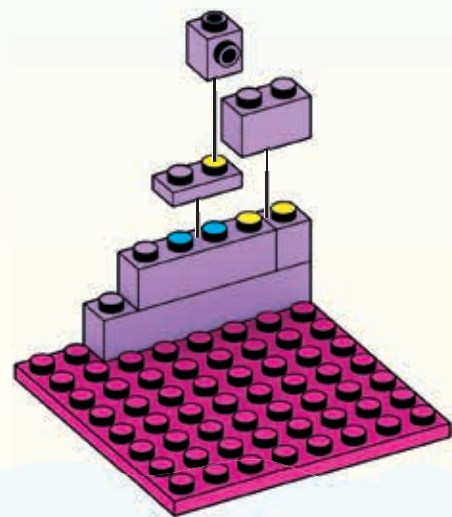



106

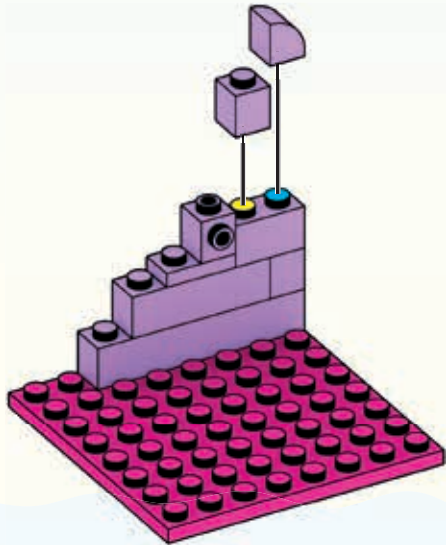

107

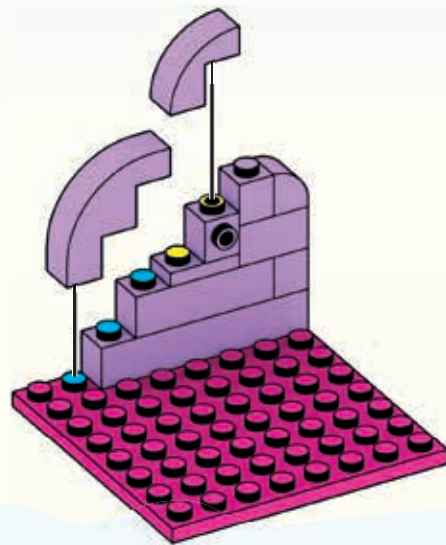
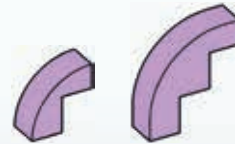



108

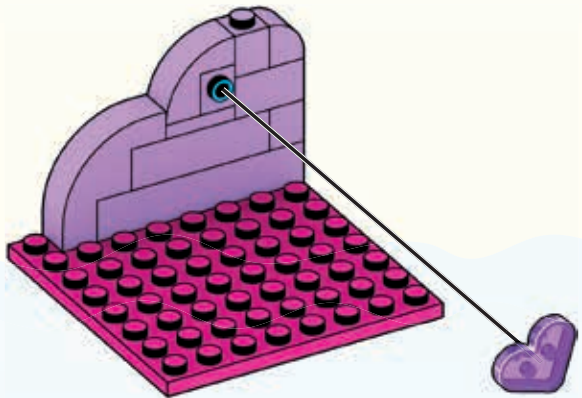

109

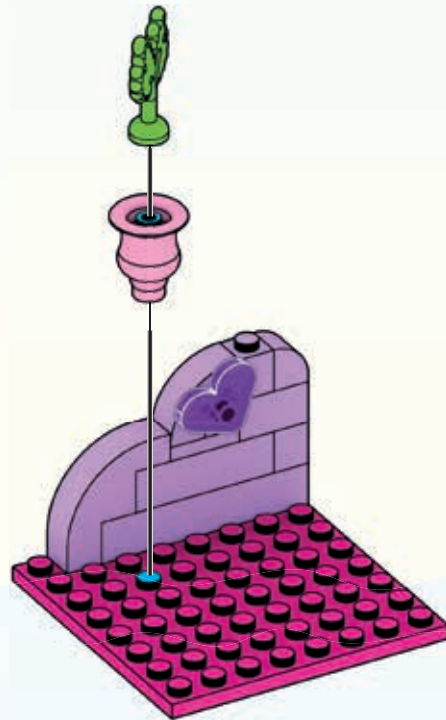



110



x2



111

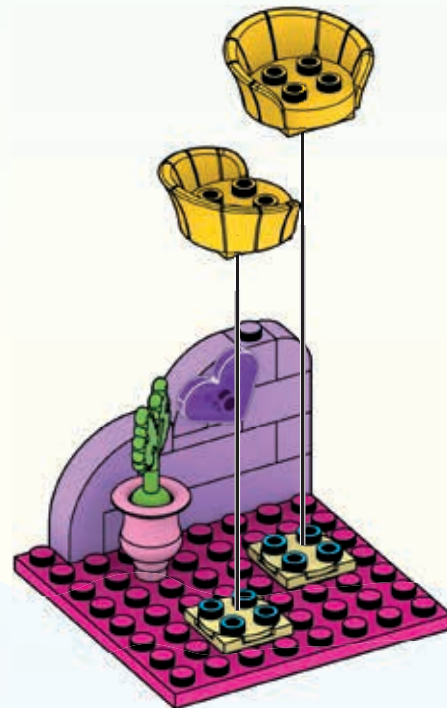



112

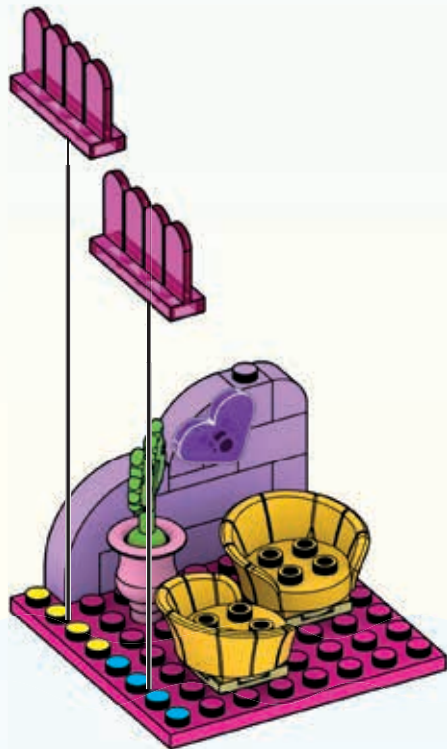

1

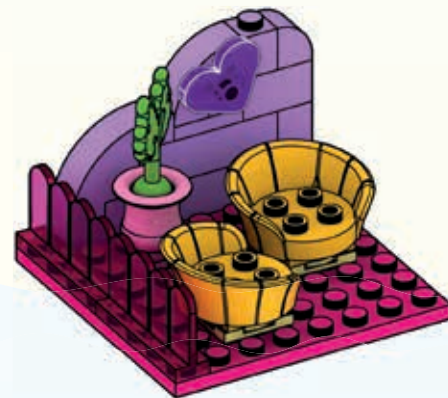

2





113

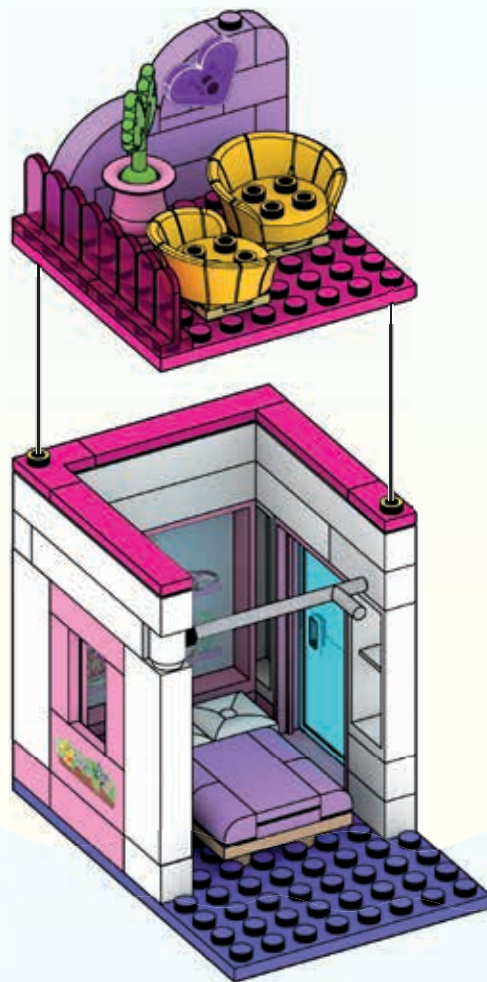



114

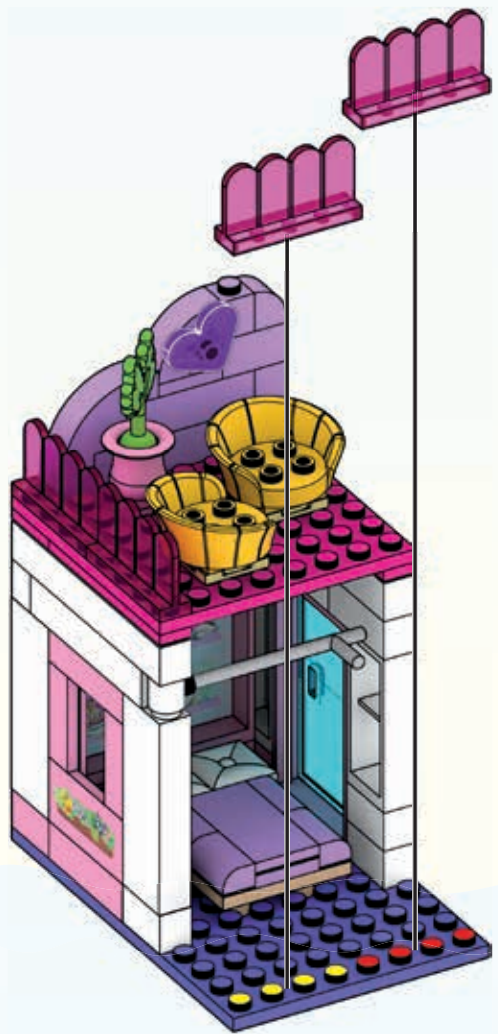

90



115

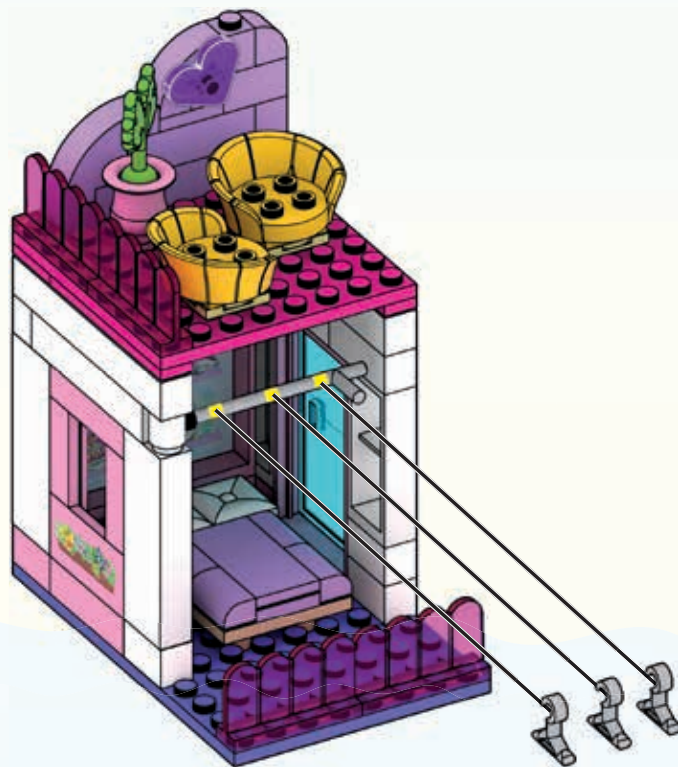

1

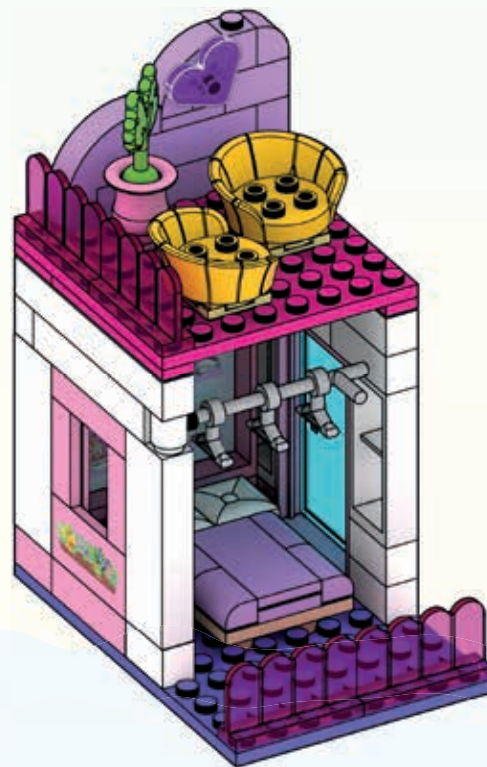

2





116

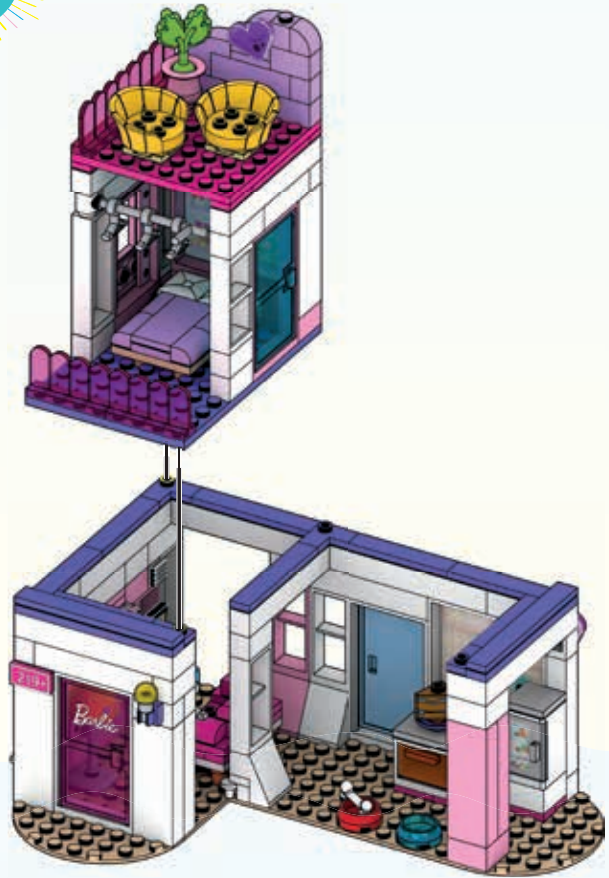

1



2

92



LET'S PLAY!
AMUSONS-NOUS!

¡AJUGAR! • A BRINCAR!
LASS UNS SPIELEN! • НАЧИНАЕМ ИГРУ!





Let's Build The Bathroom! Construisons la salle de bain !

¡Vamos a construir el baño!
Vamos construir a casa de banho!
Das Badezimmer bauen!
Построим ванную!

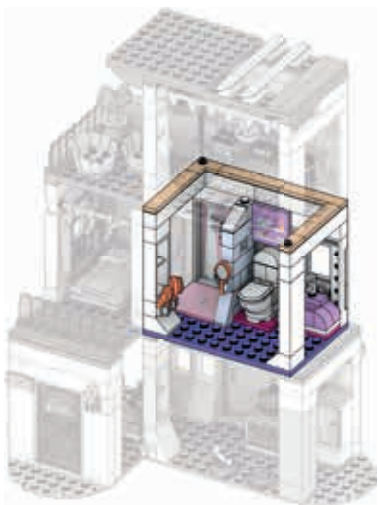

WHAT WILL YOU REVEAL? QU'ALLEZ-VOUS DÉCOUVRIR?

¿QUÉ VAS A REVELAR? • O QUE VOCÊ VAI REVELAR?
WELCHE PUPPE KOMMT ZUM VORSCHIN?
КАКУЮ КУКЛУ ВЫ ОТКРОЕТЕ?





117

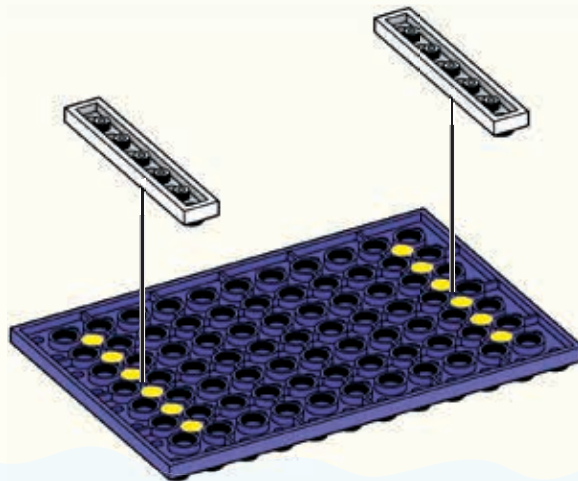
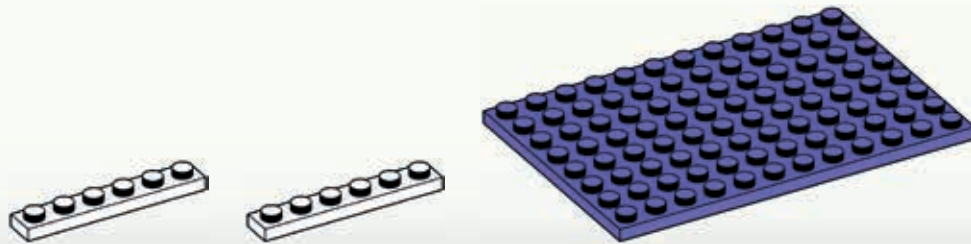



118

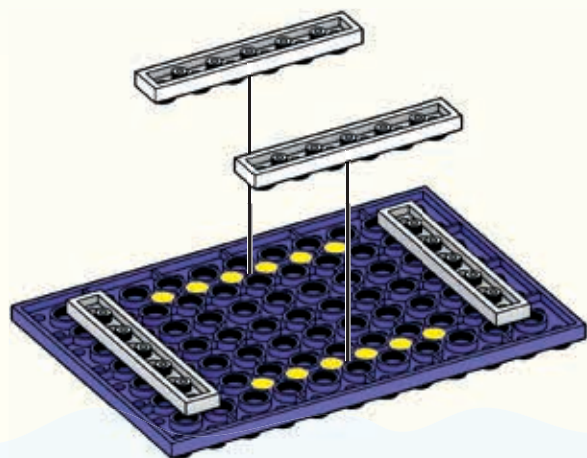

1

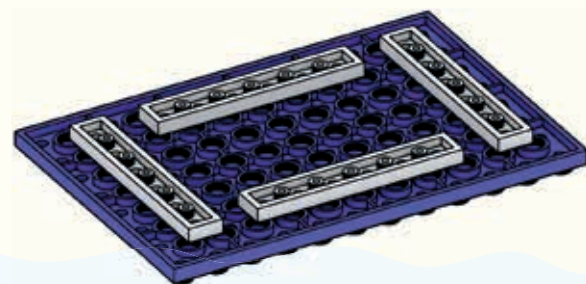

2





119



120

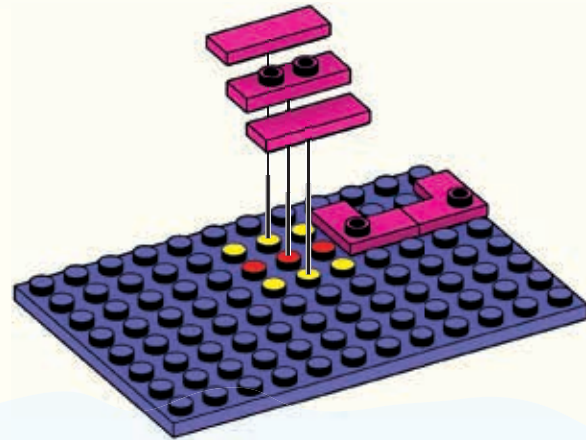
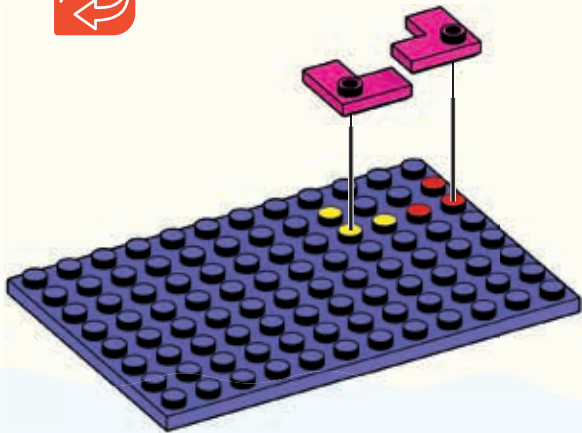



121

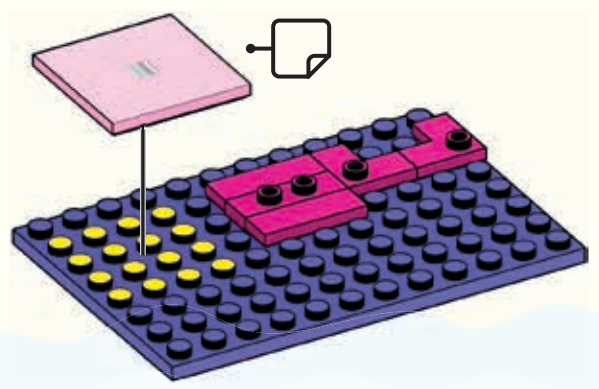

122

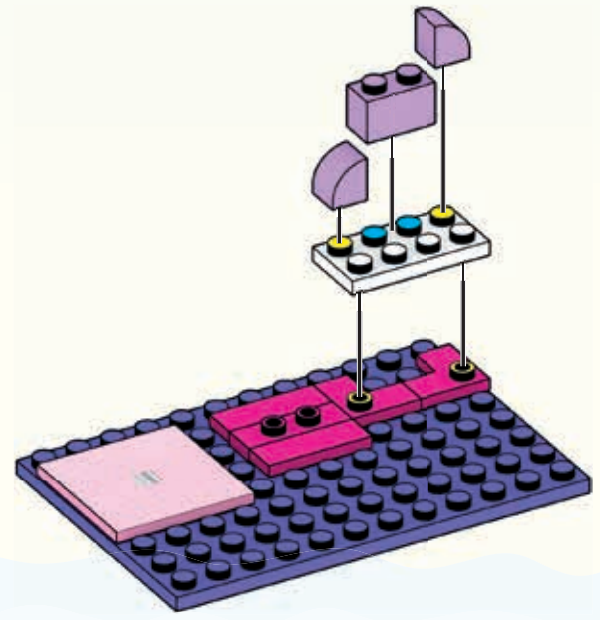



123

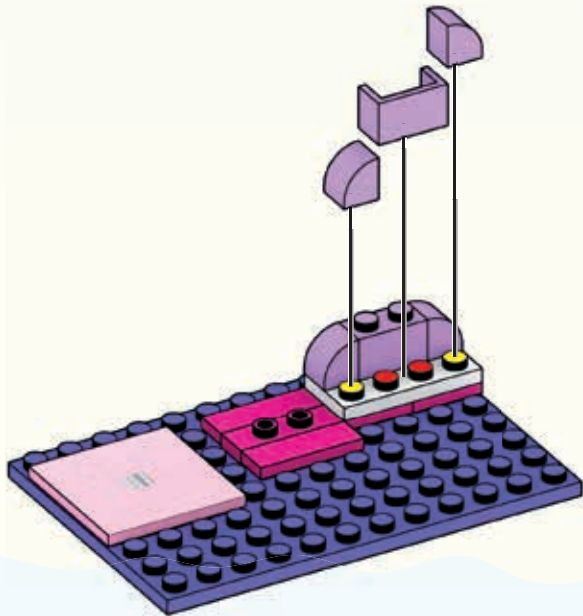

124

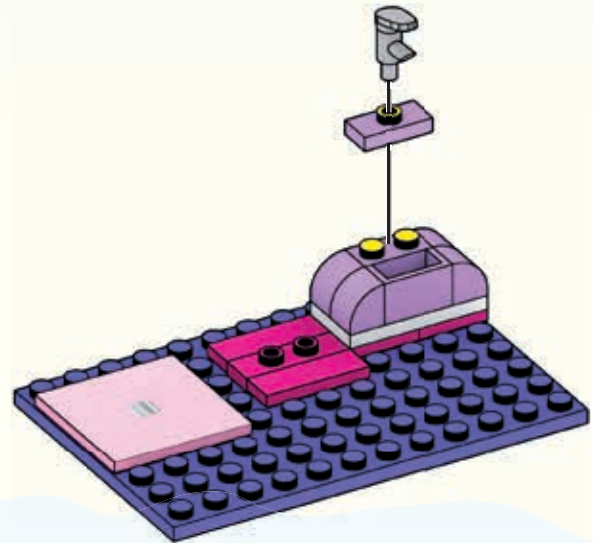



125

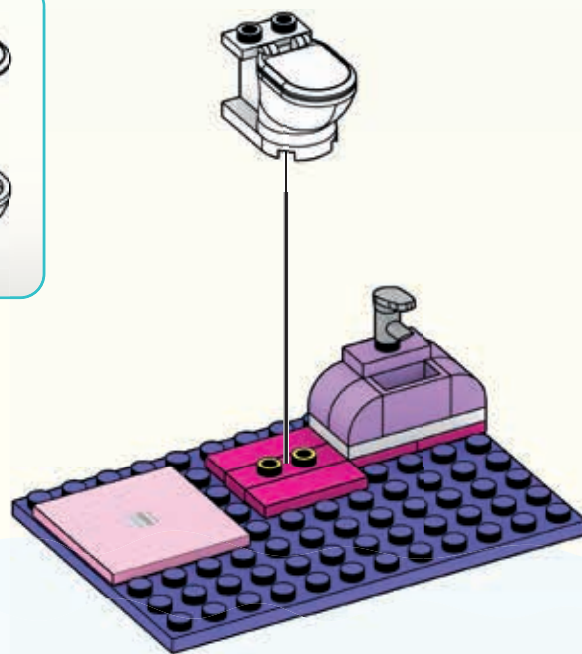
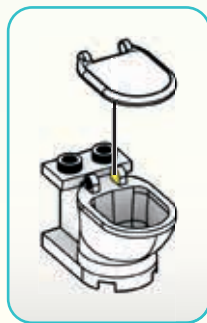

100



126

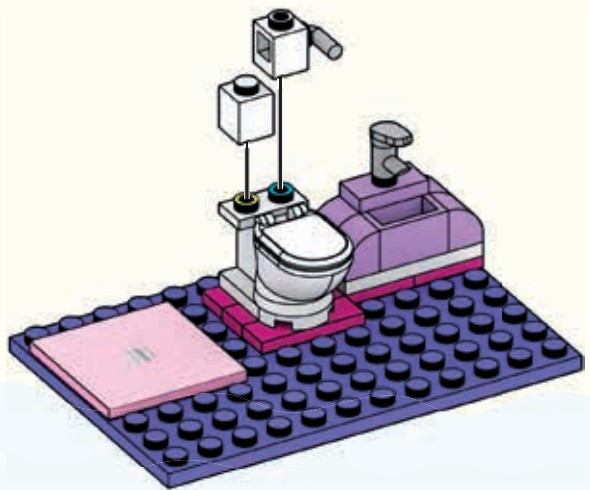
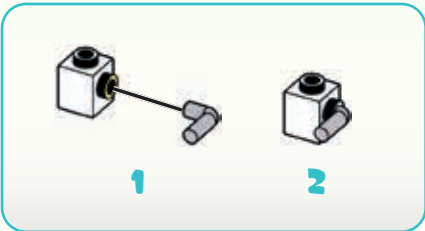

101





127

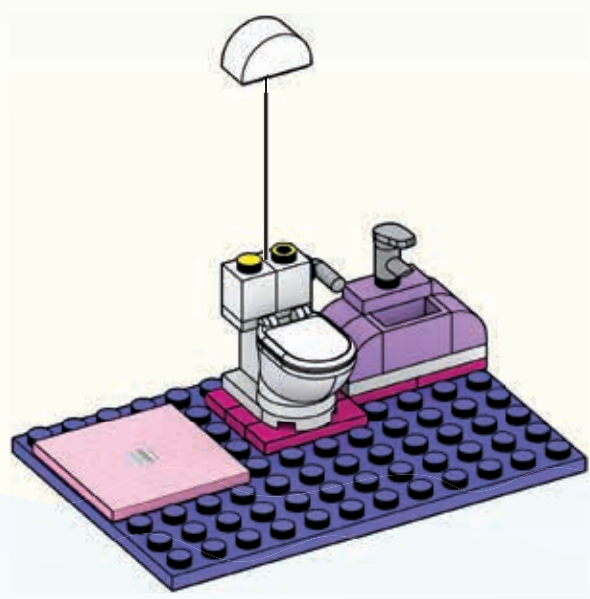

128

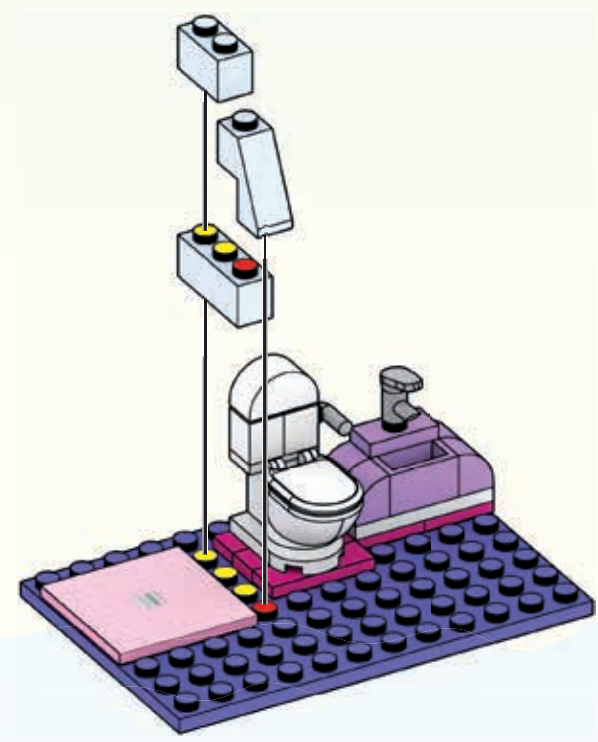



129

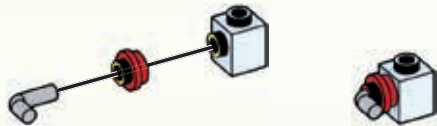

1

2

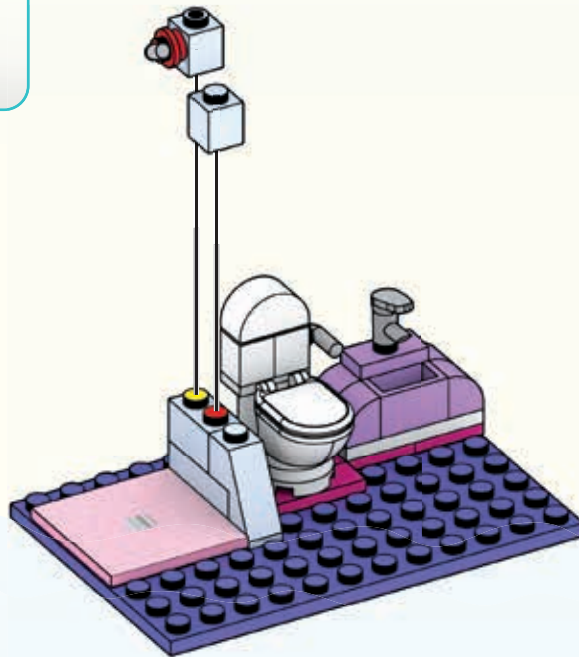

103





130

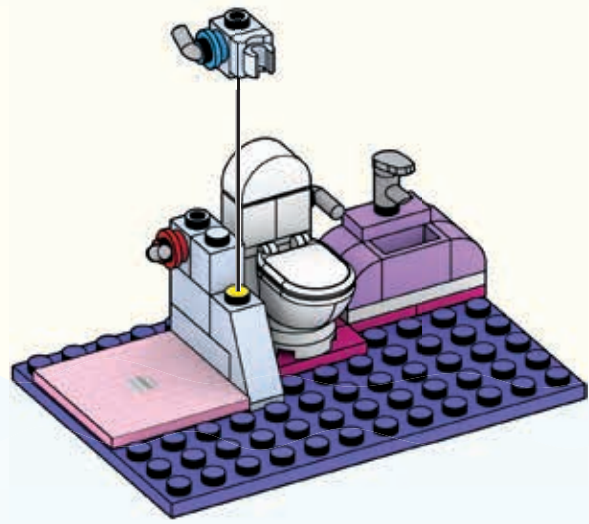
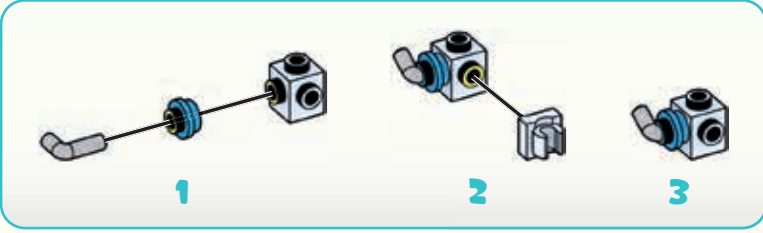

104



131

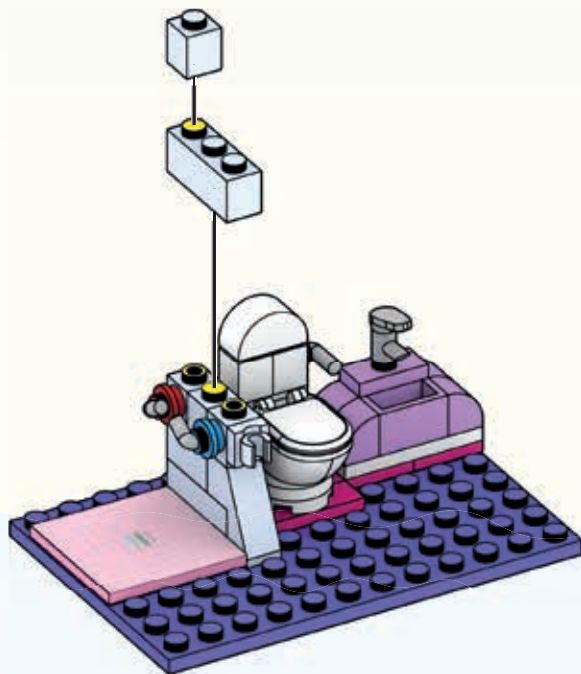

132

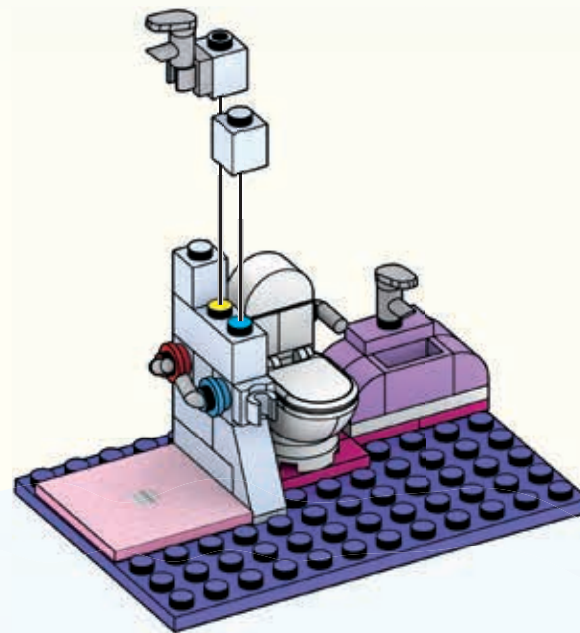
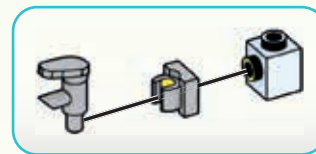



133

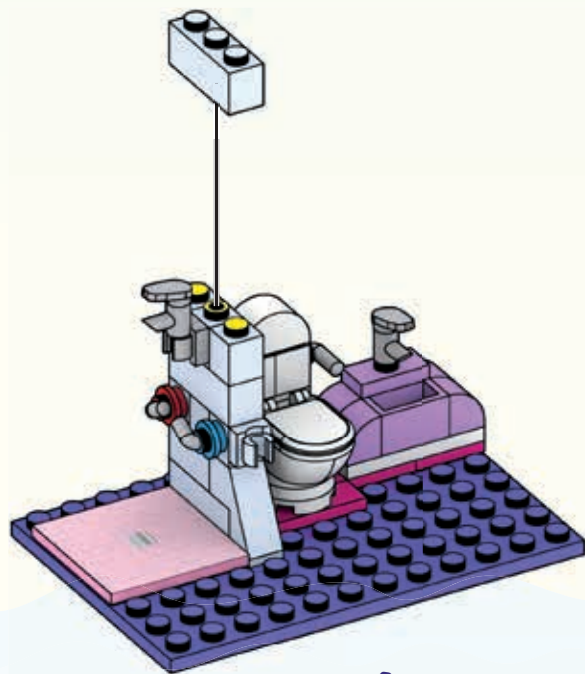
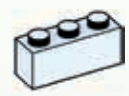

1

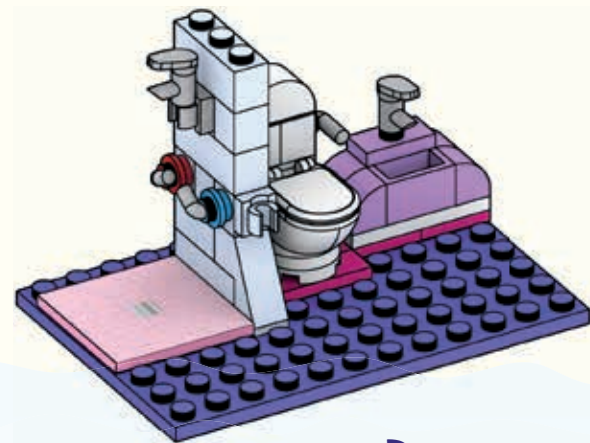

2





134

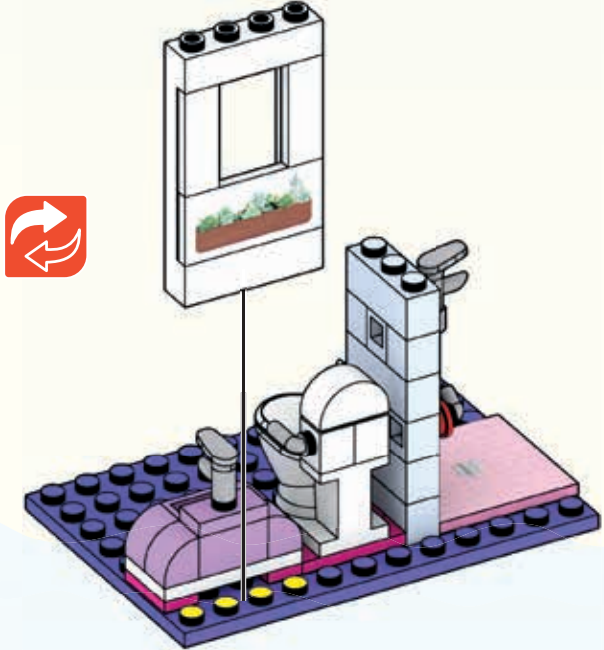
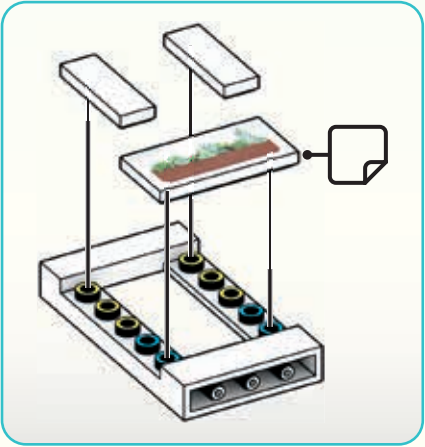
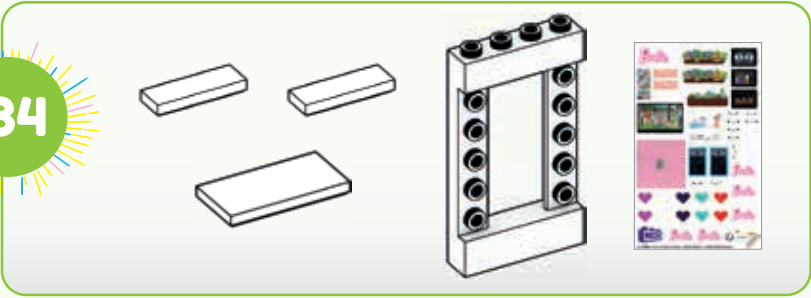

107





135

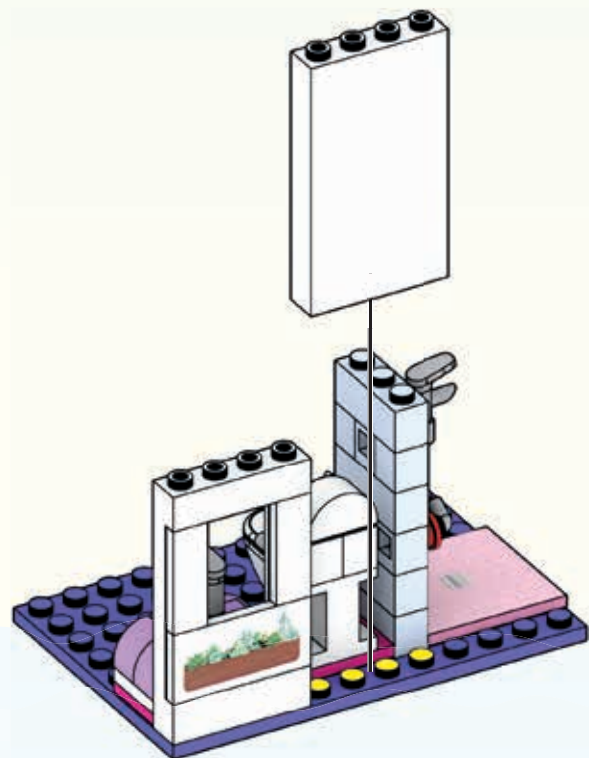

108



136

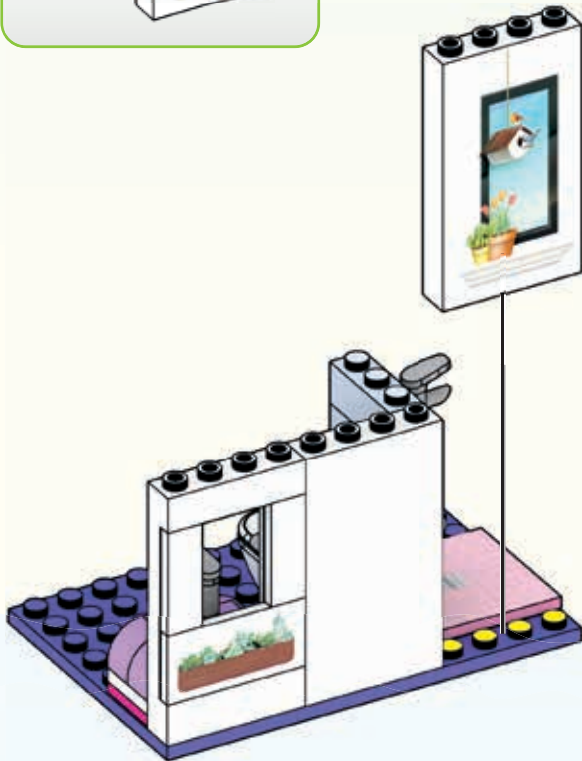

137

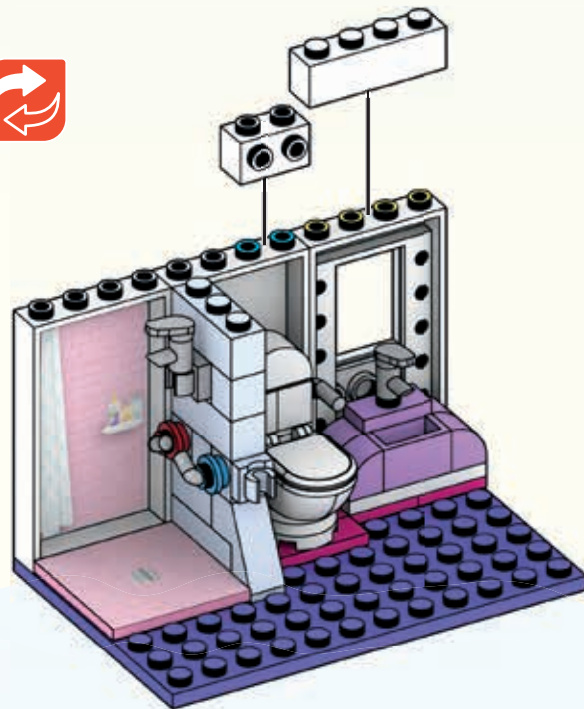



138

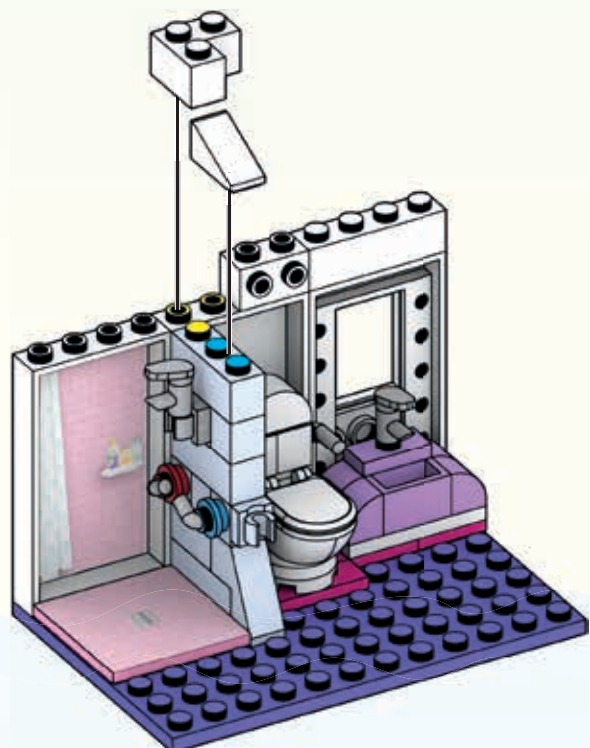

139

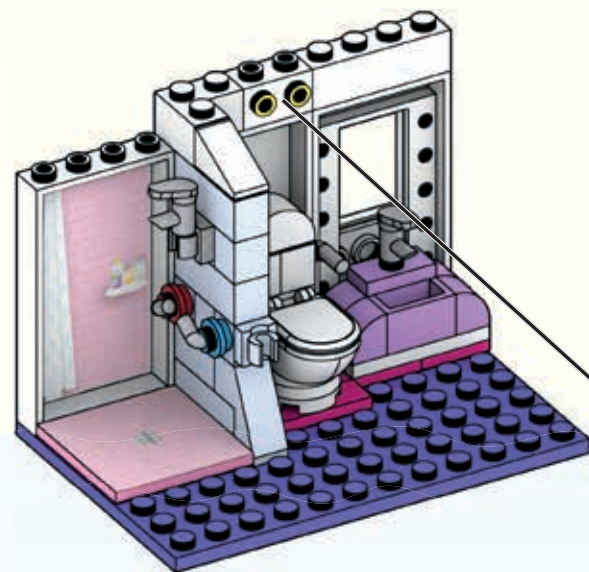

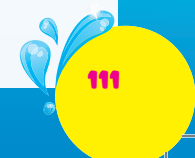
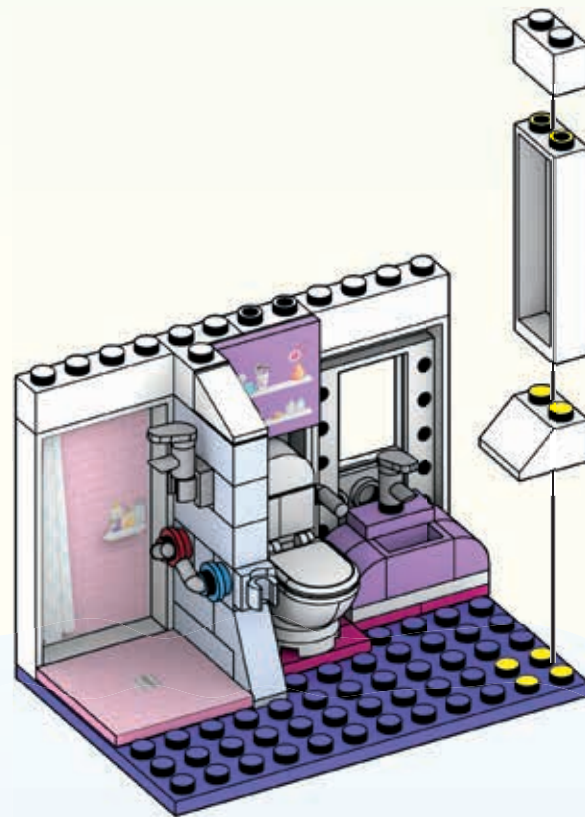
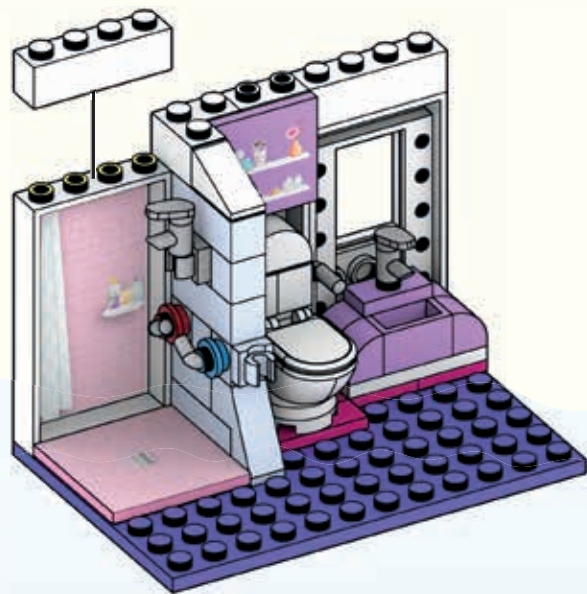
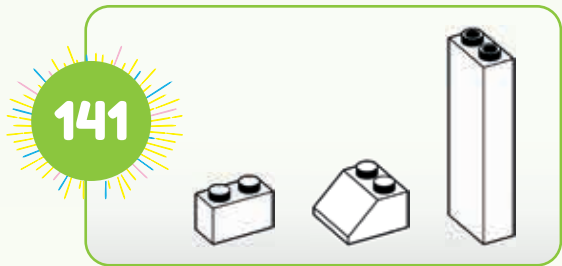
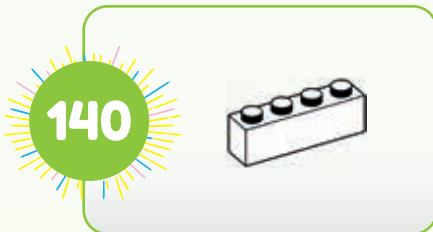



142

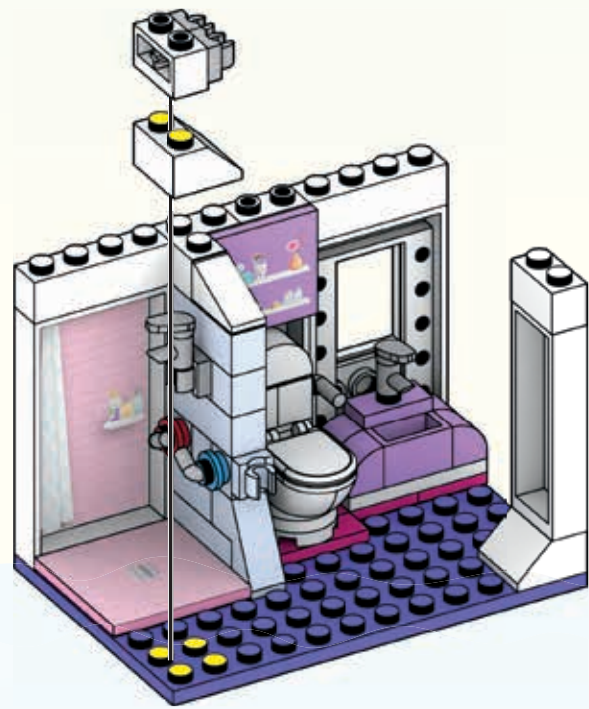
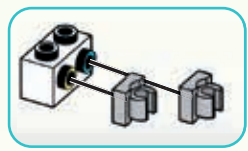

112

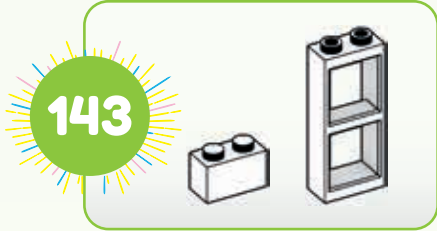



144

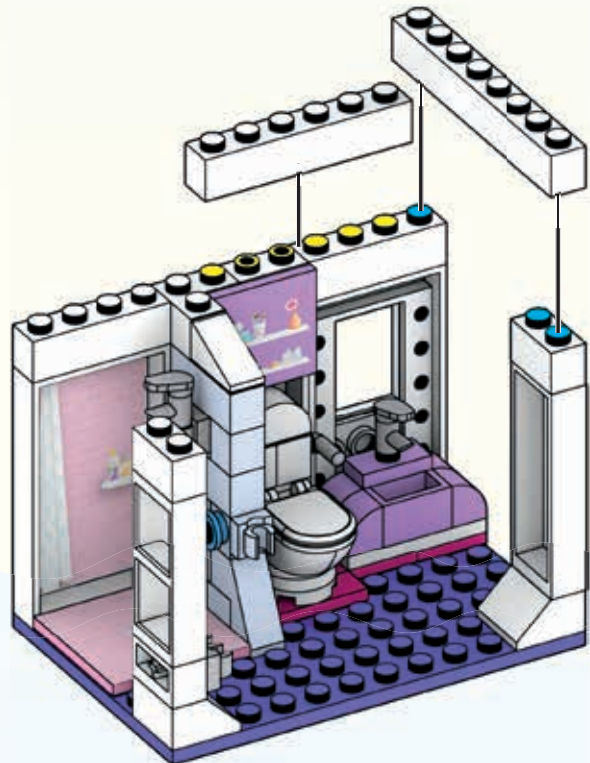
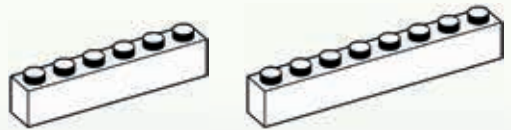

145

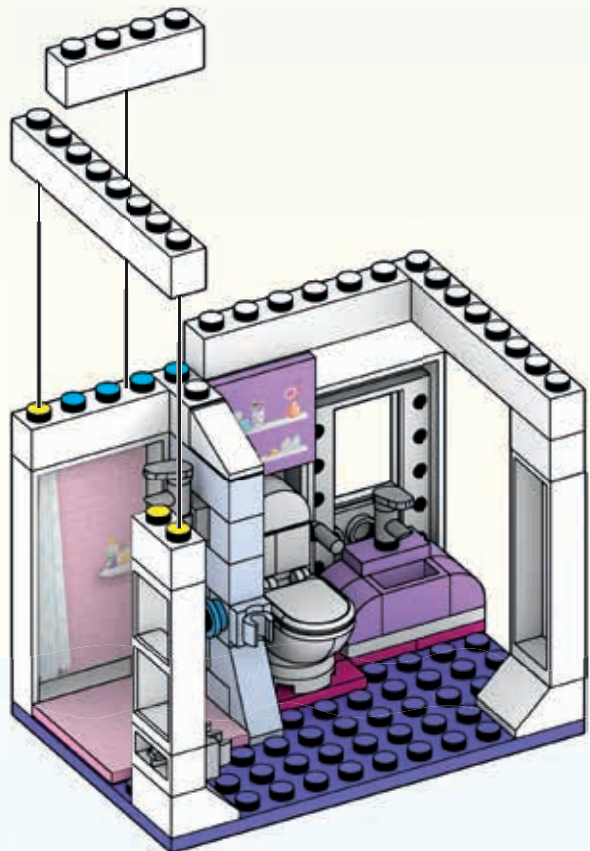

114



146

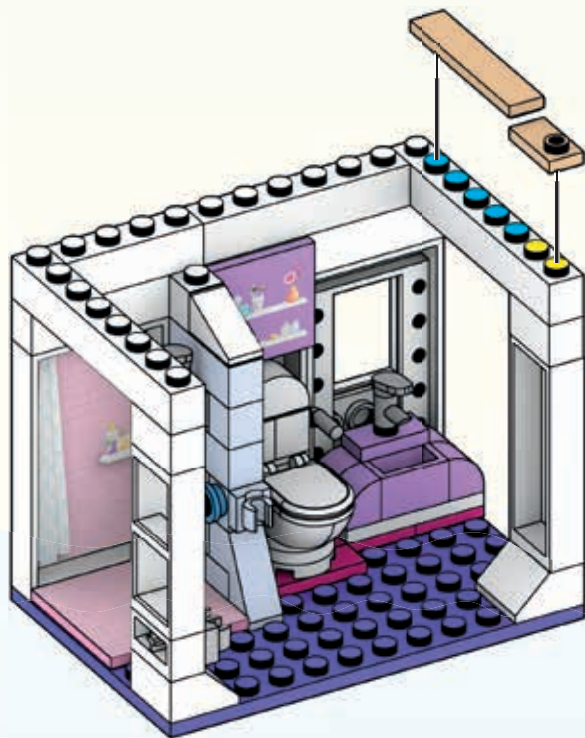

147

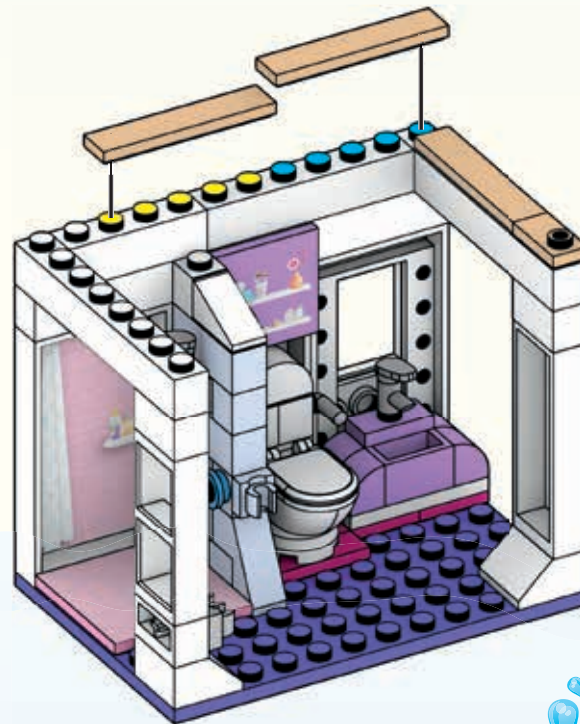

115





148



149

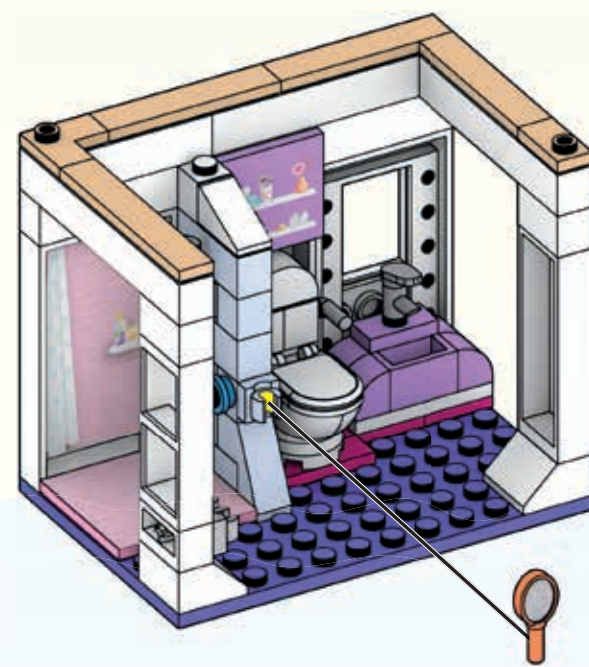
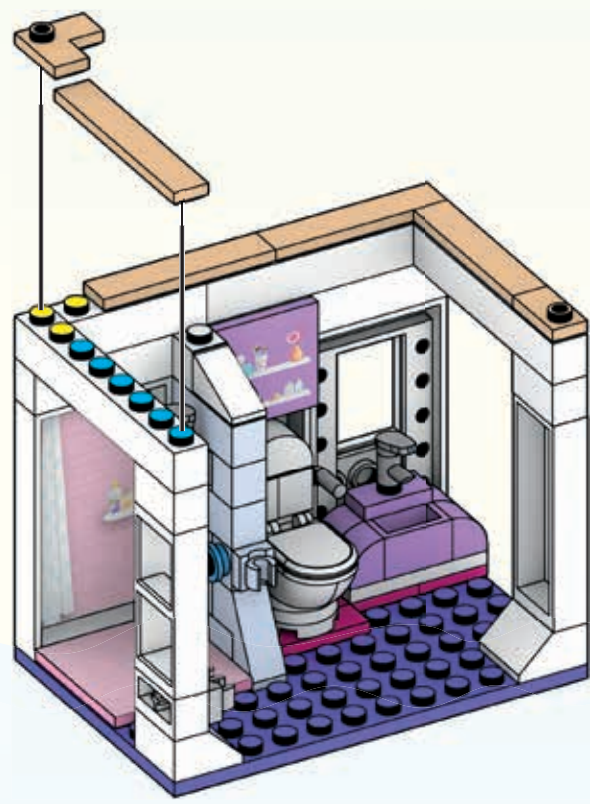

116





150

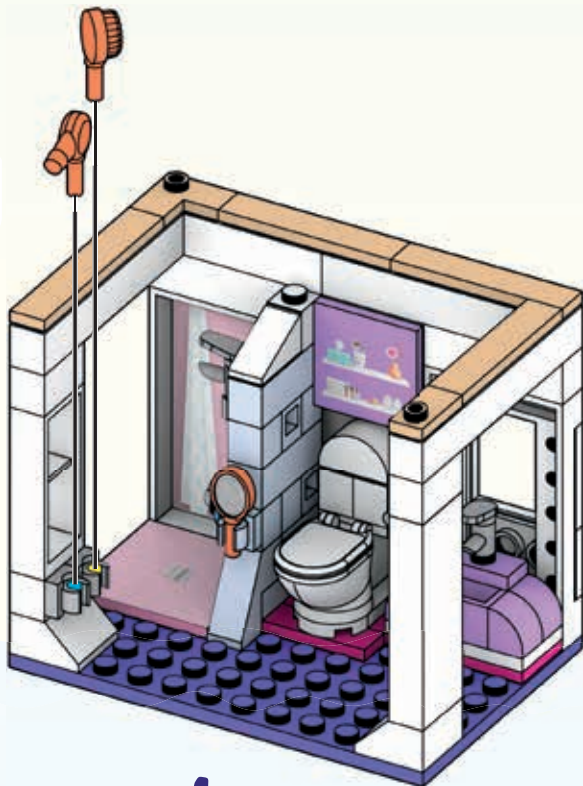

1

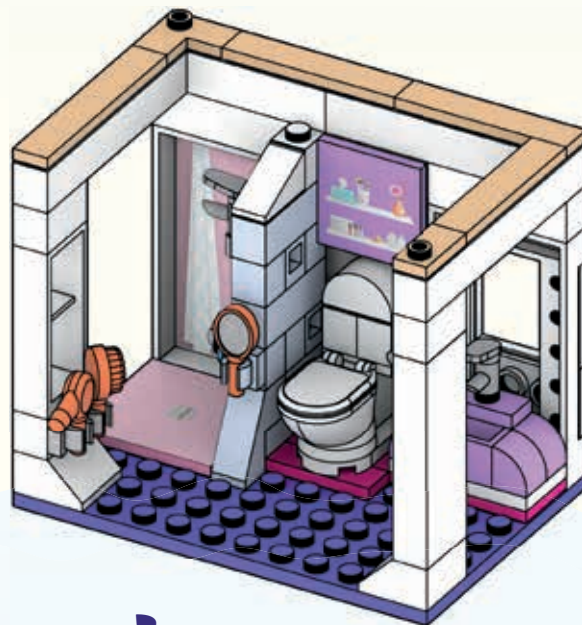

2





151

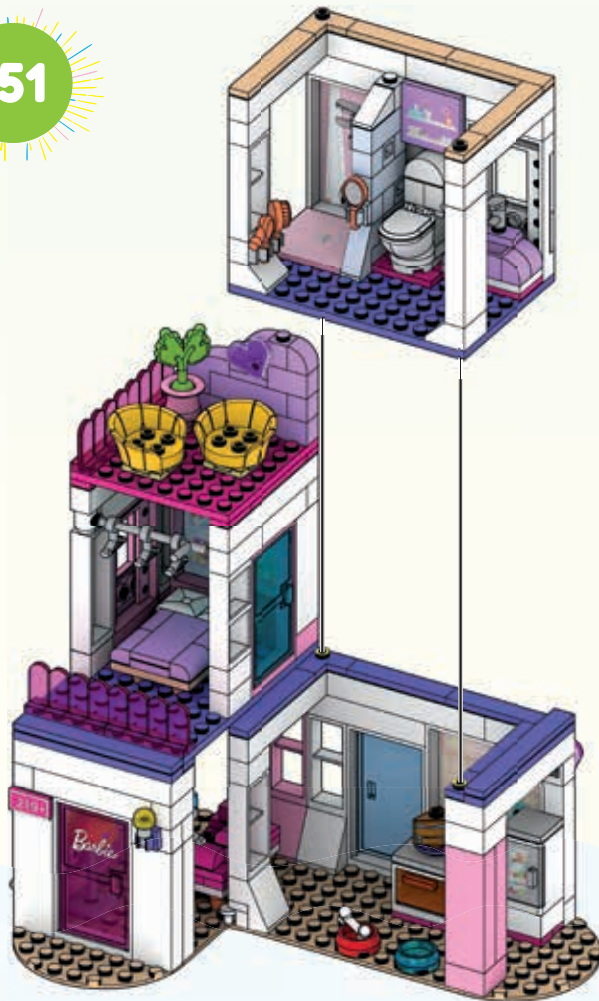

1



2

118



LET'S PLAY!
AMUSONS-NOUS!

¡AJUGAR! • A BRINCAR!
LASS UNS SPIELEN! • НАЧИНАЕМ ИГРУ!





Let's Build The Party Room! Construisons l'espace discothèque !

¡Vamos a construir la sala de fiestas!
Vamos construir o salão de festas!
Den Partyraum bauen!
Построим комнату для вечеринок!

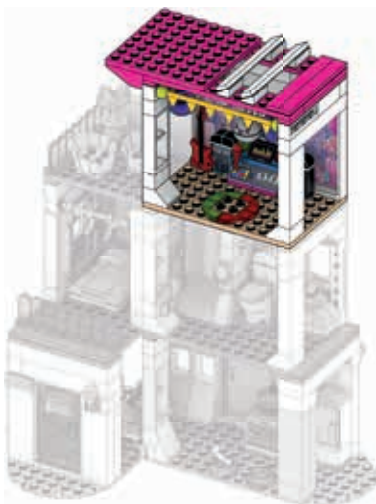

WHAT WILL YOU REVEAL? QU'ALLEZ-VOUS DÉCOUVRIR?

¿QUÉ VAS A REVELAR? • O QUE VOCÊ VAI REVELAR?
WELCHE PUPPE KOMMT ZUM VORSCHNEIN?
КАКУЮ КУКЛУ ВЫ ОТКРОЕТЕ?





CUSTOMIZE YOUR BARBIE® MICRO-DOLL!
PERSONNALISEZ VOTRE MICRO-POUPÉE BARBIE®!

PERSONALIZA TU MICROMUÑECA BARBIE®! • PERSONALIZE A SUA MICROBONECA BARBIE®!
DIE BARBIE MIKROPUPPE LÄSST SICH IMMER WIEDER NEU GESTALTEN! • СОЗДАЙТЕ СВОЮ МИКРОКУКЛУ BARBIE®!



1



2





152

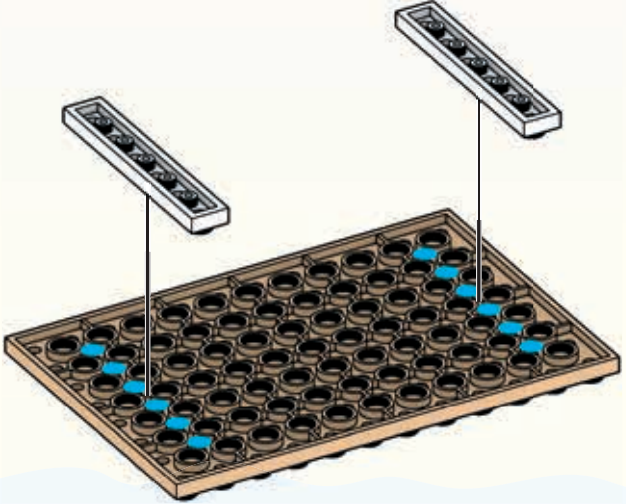
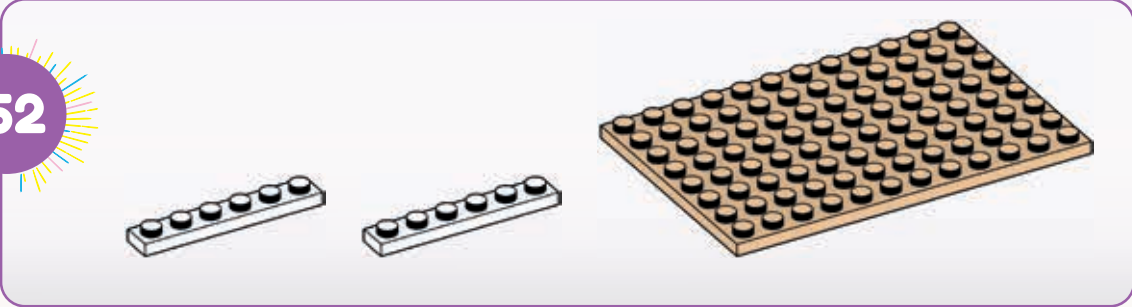

122





153

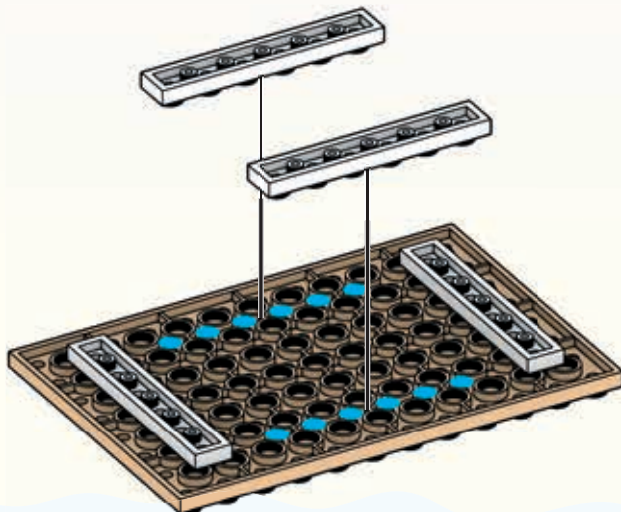

1

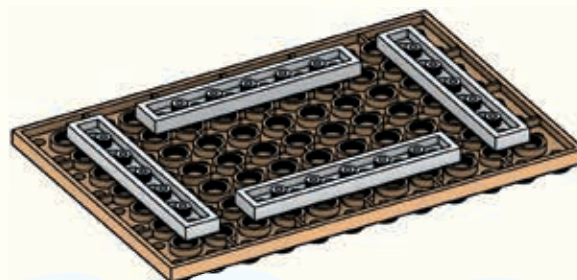

2





154

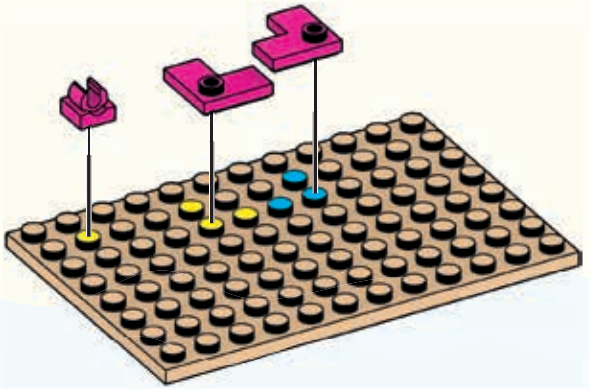

155

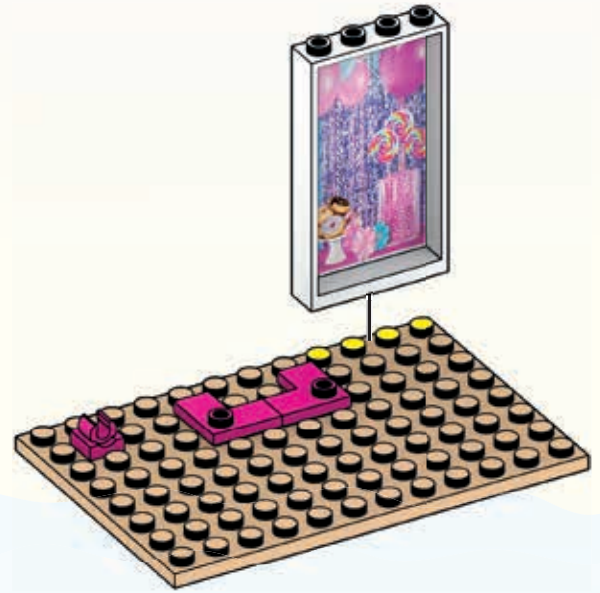

124





156

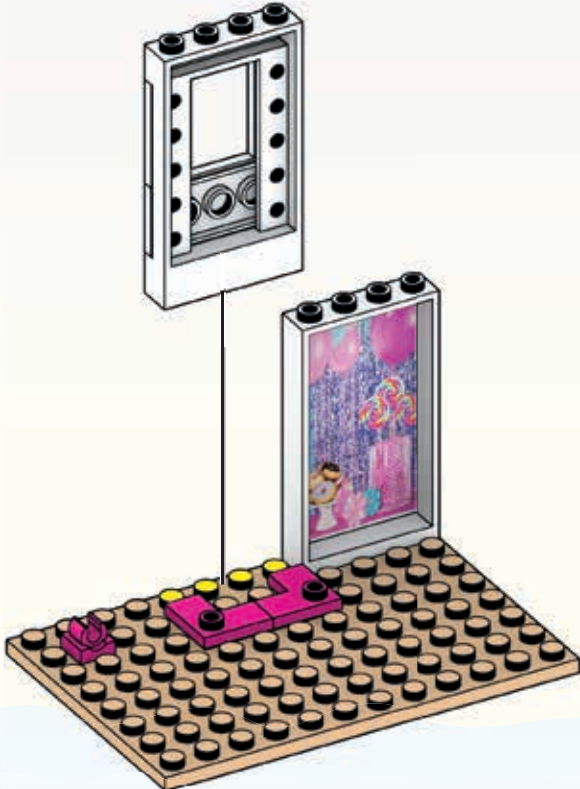
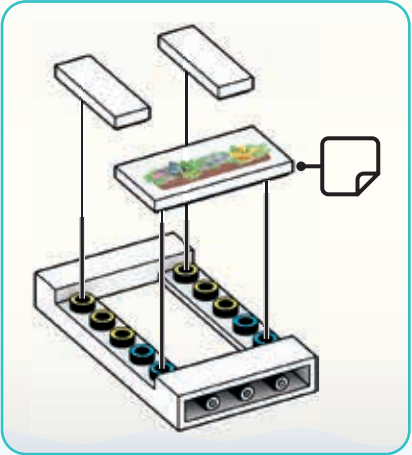
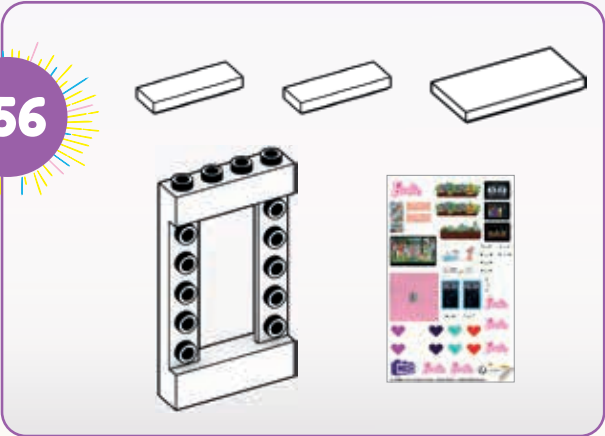

125





157

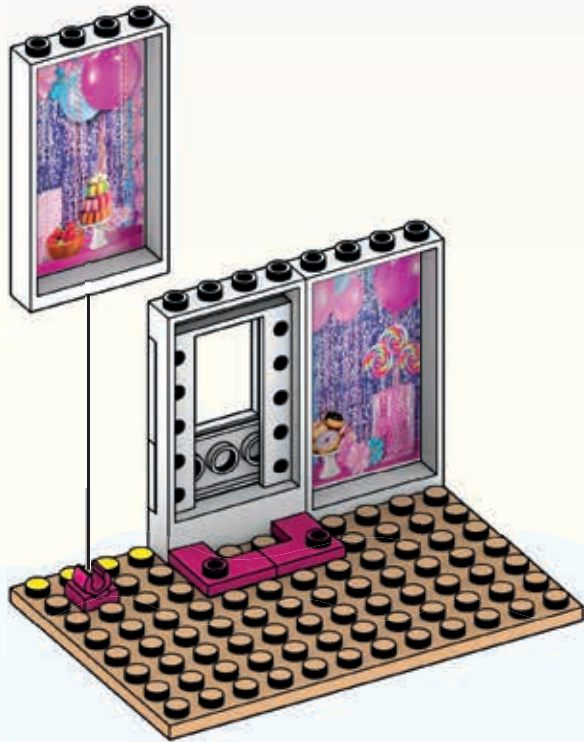

158

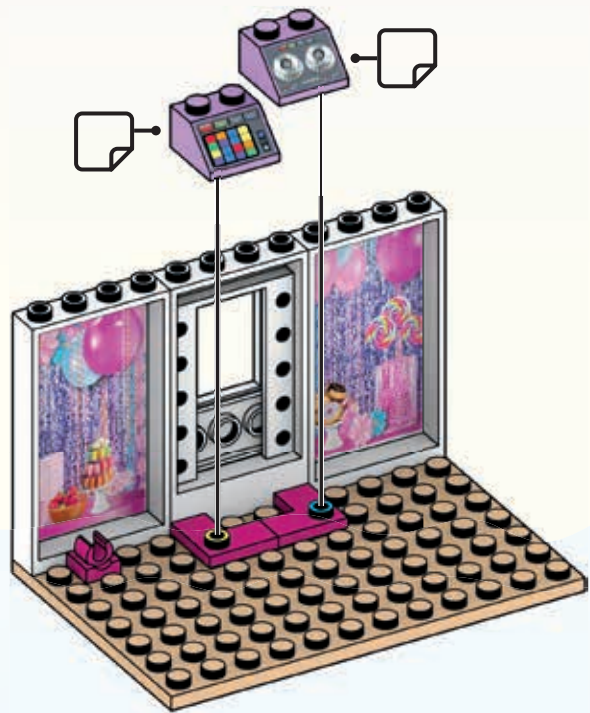

126





159

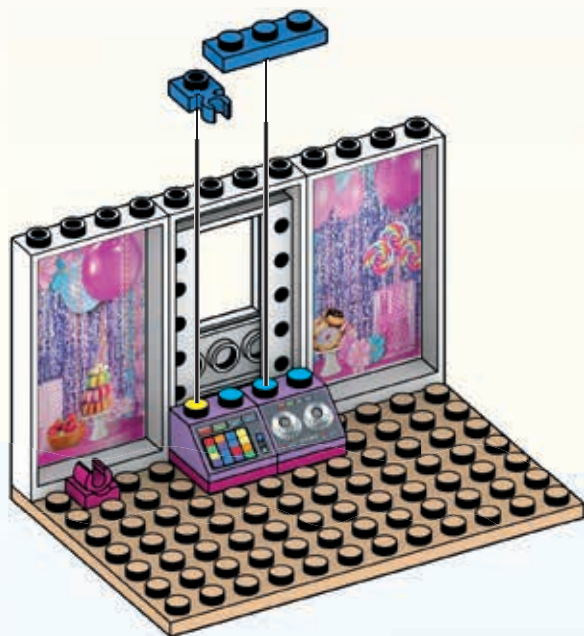

160

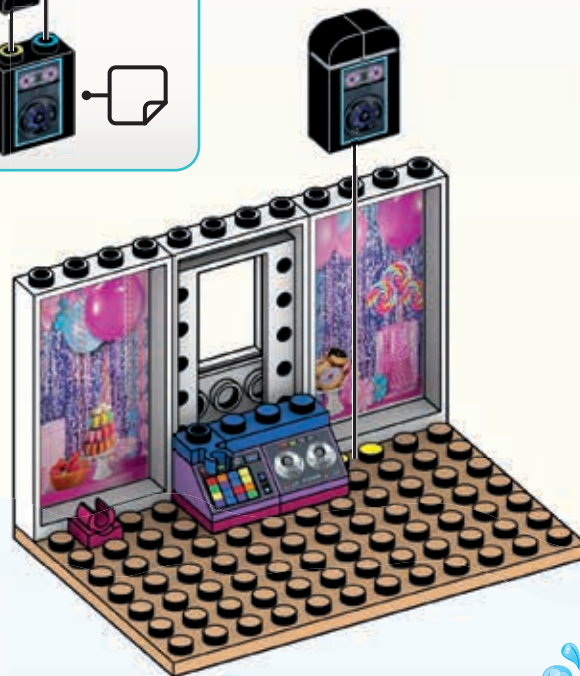
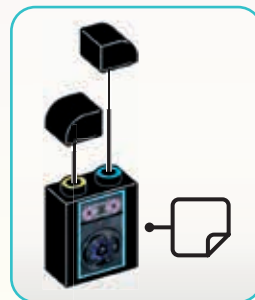

127





161

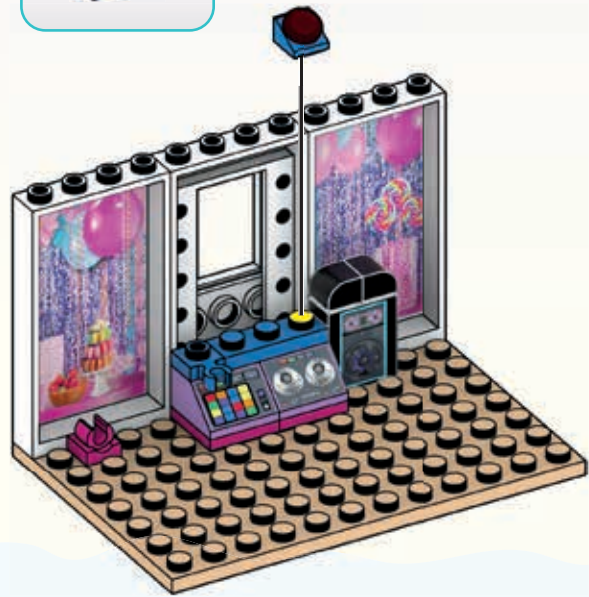

128





162

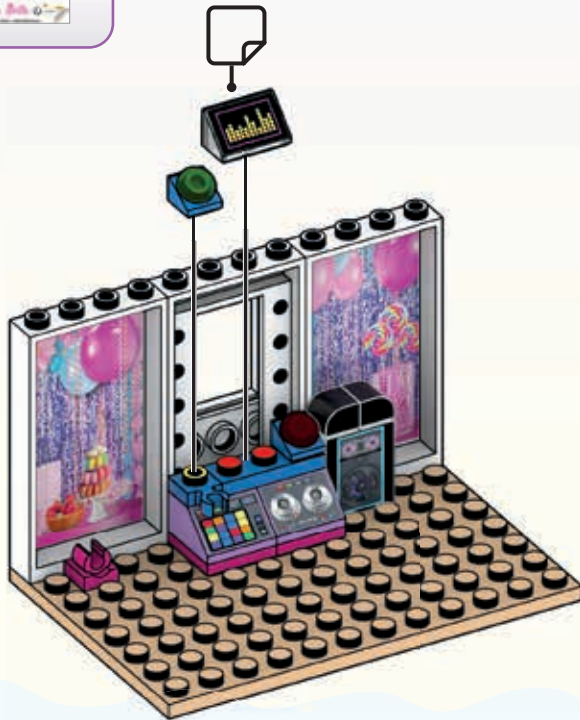
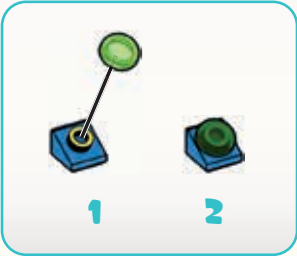
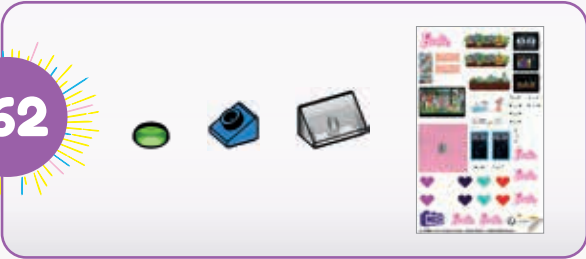



163

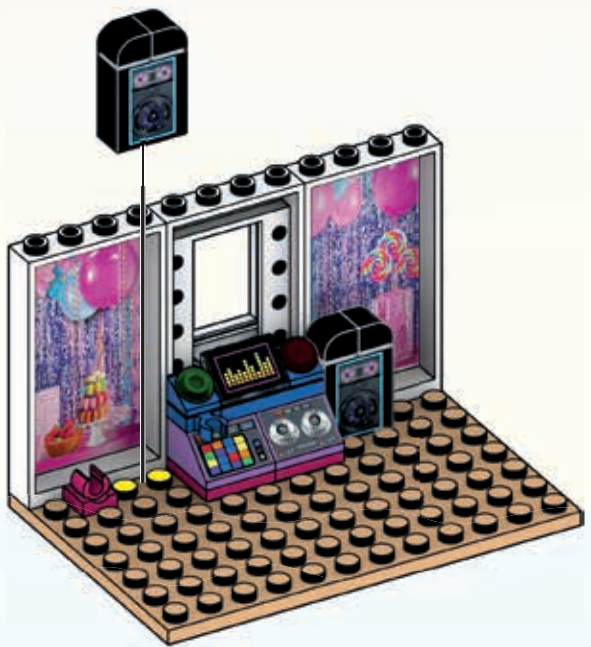
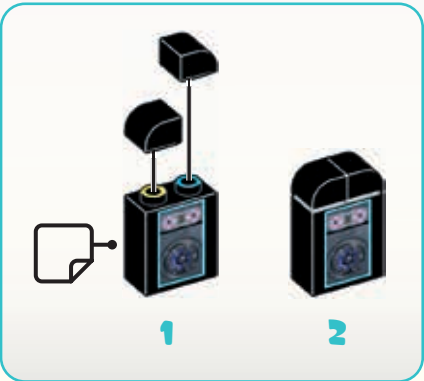
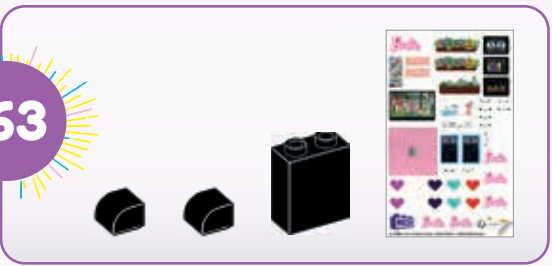

130

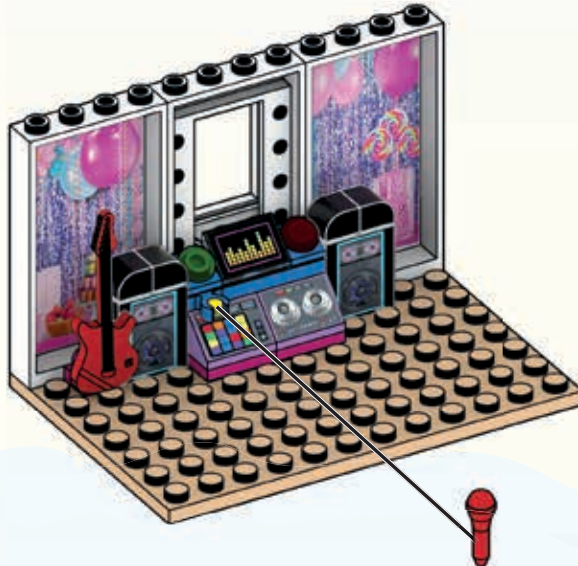
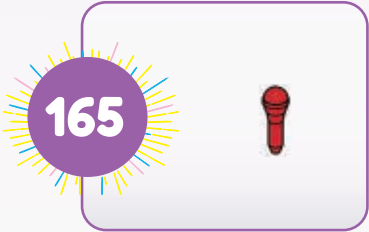



166

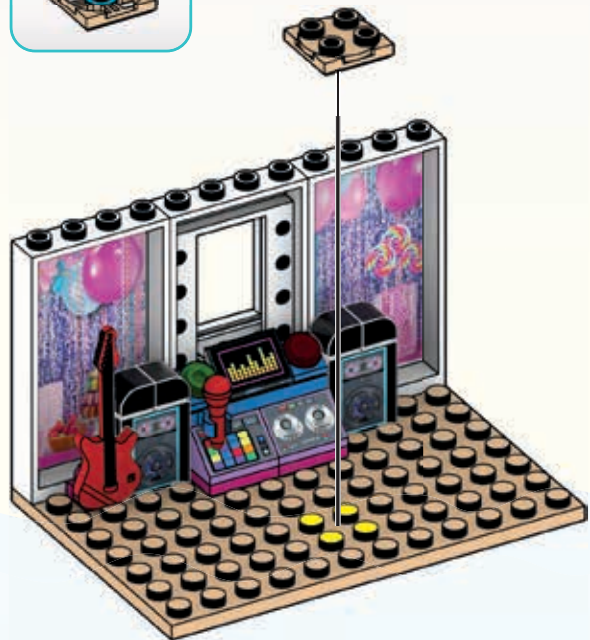

167

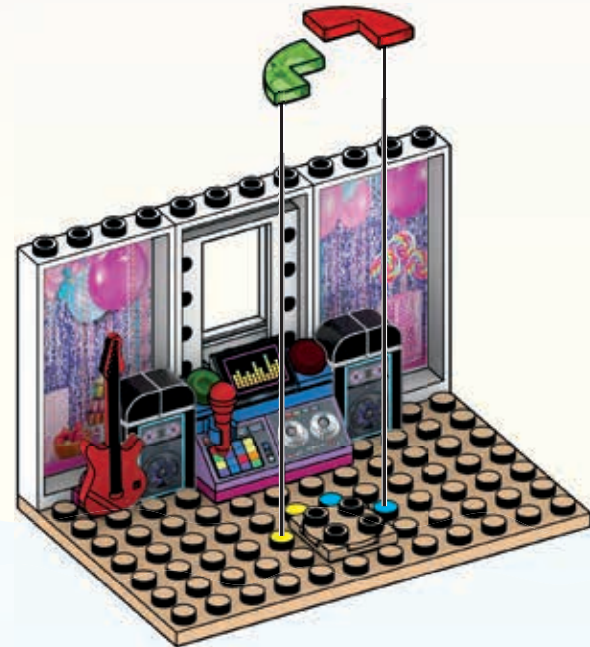

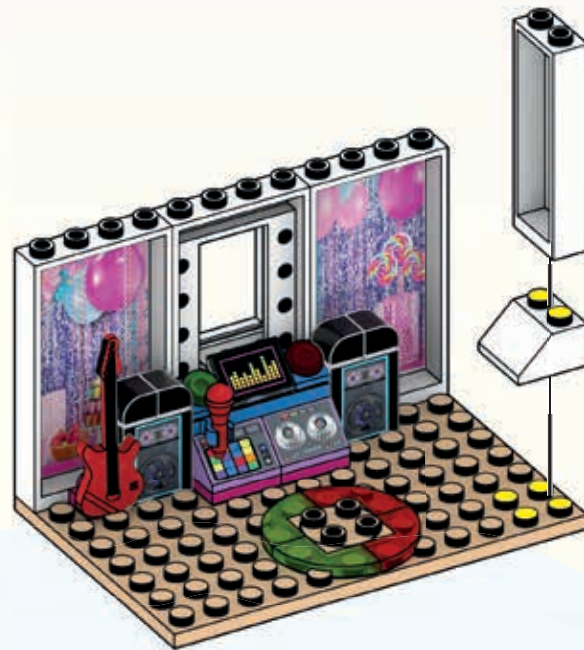
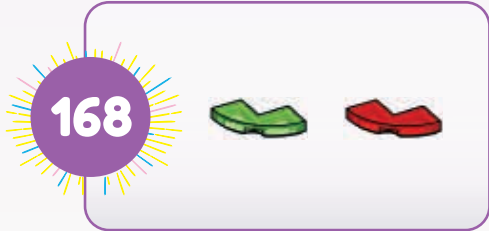



170

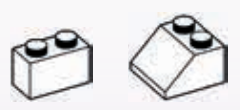

171

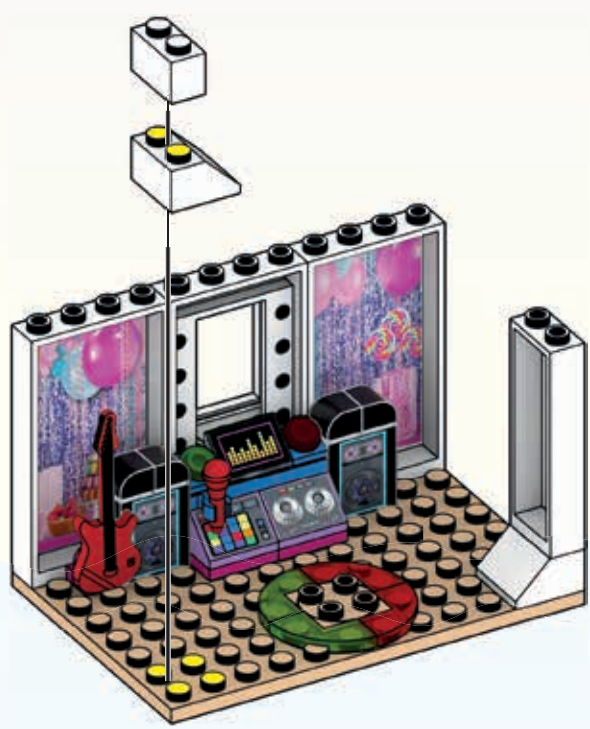
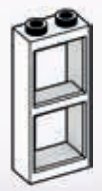

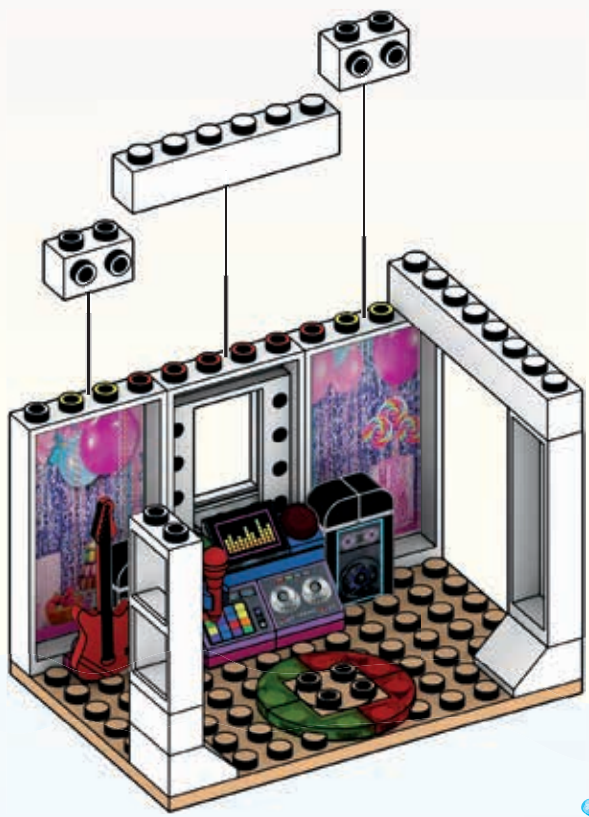
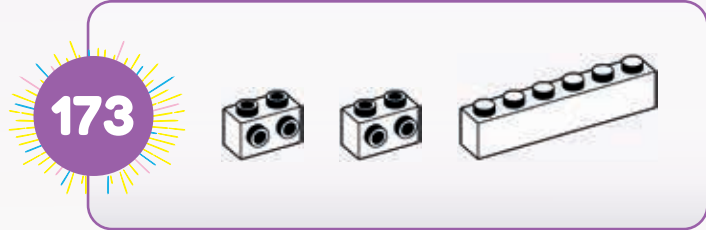
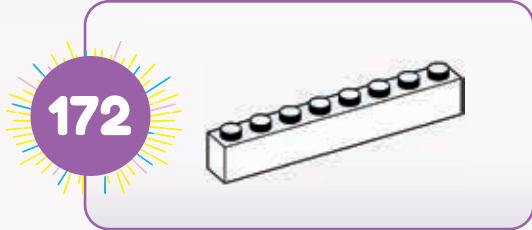



174

1 **2**



1 **2**





175



176

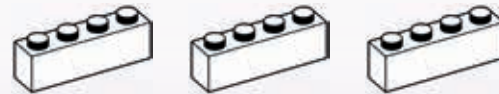



177



1



2

138





178



179





180



1

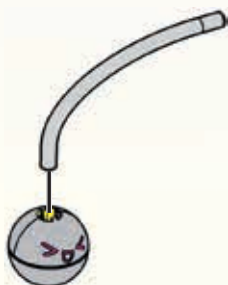

2

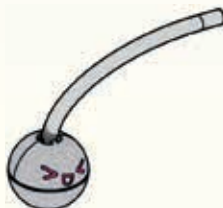

3

181



1

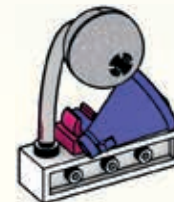

2

140



182



1



2





183

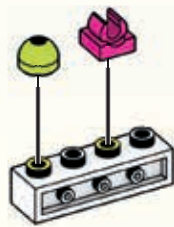

1



2



3

142



184



143





185

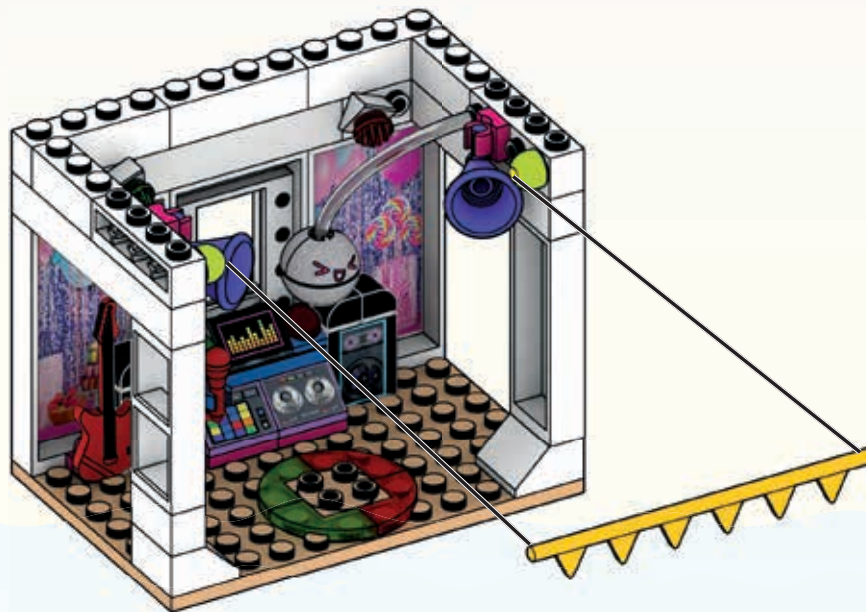



186



187



145





188



1



2

146





189

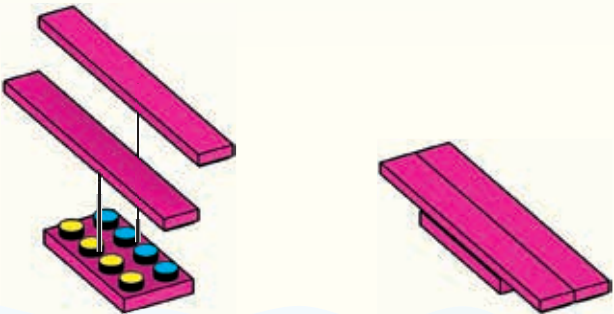
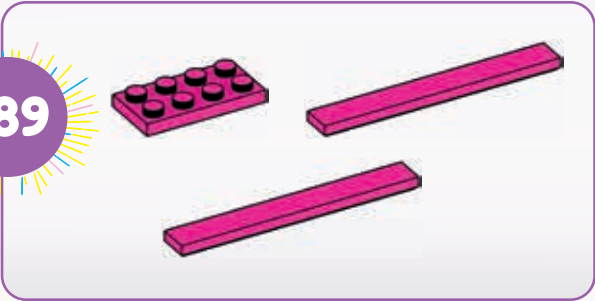

1

2

190

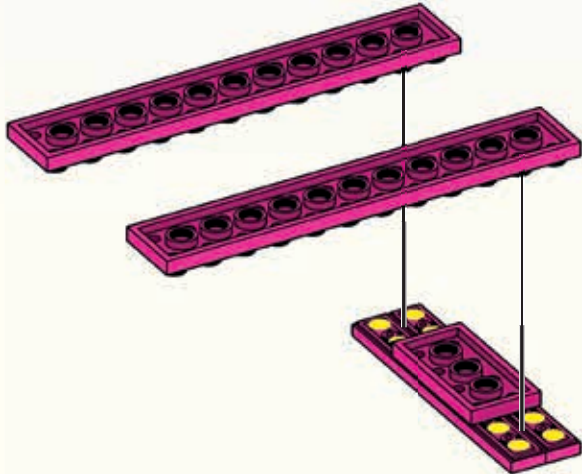
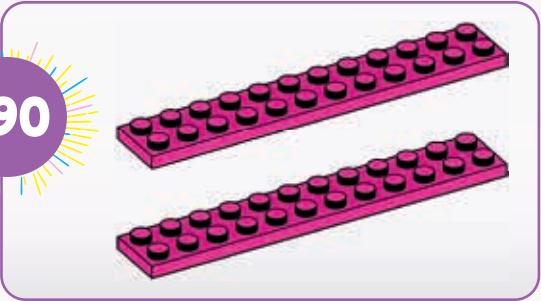

147





191

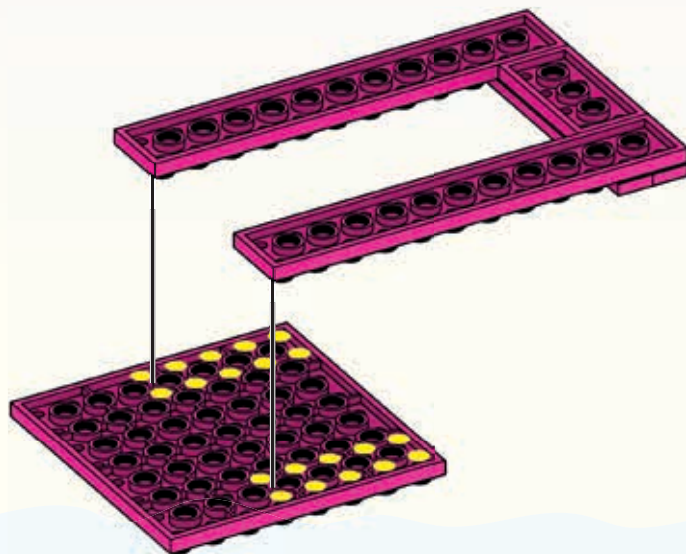

148





192

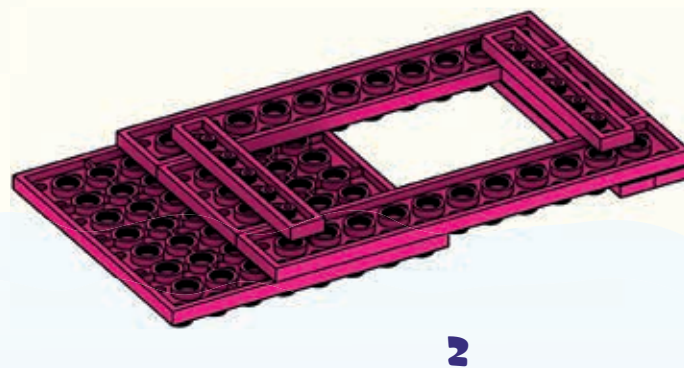
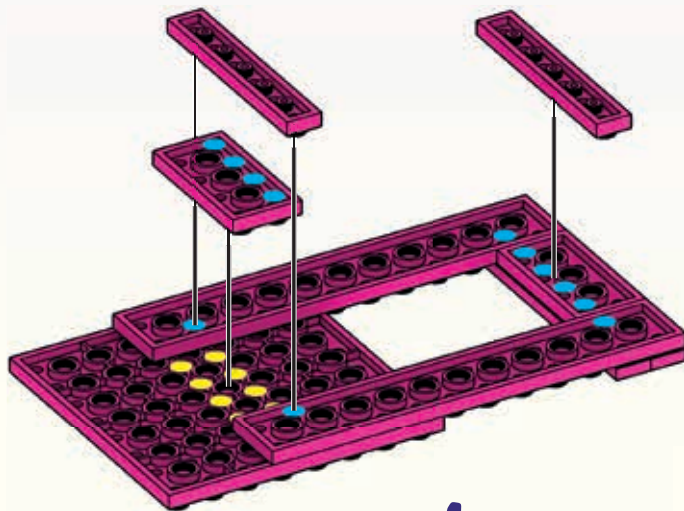

149





193

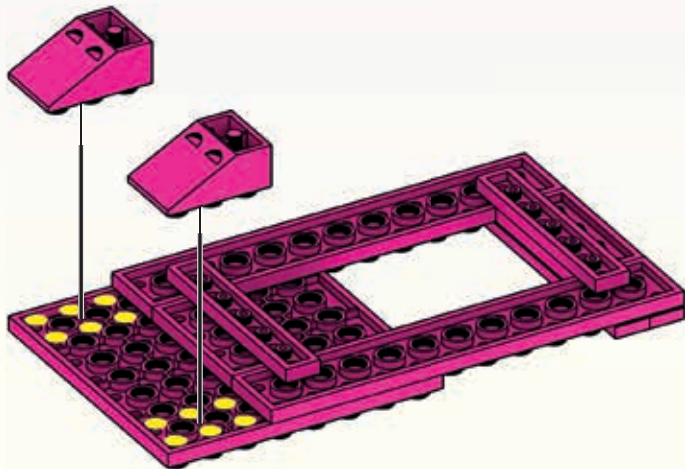

1

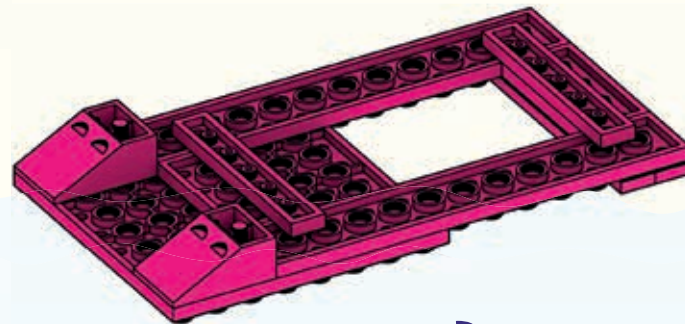

2

150





194

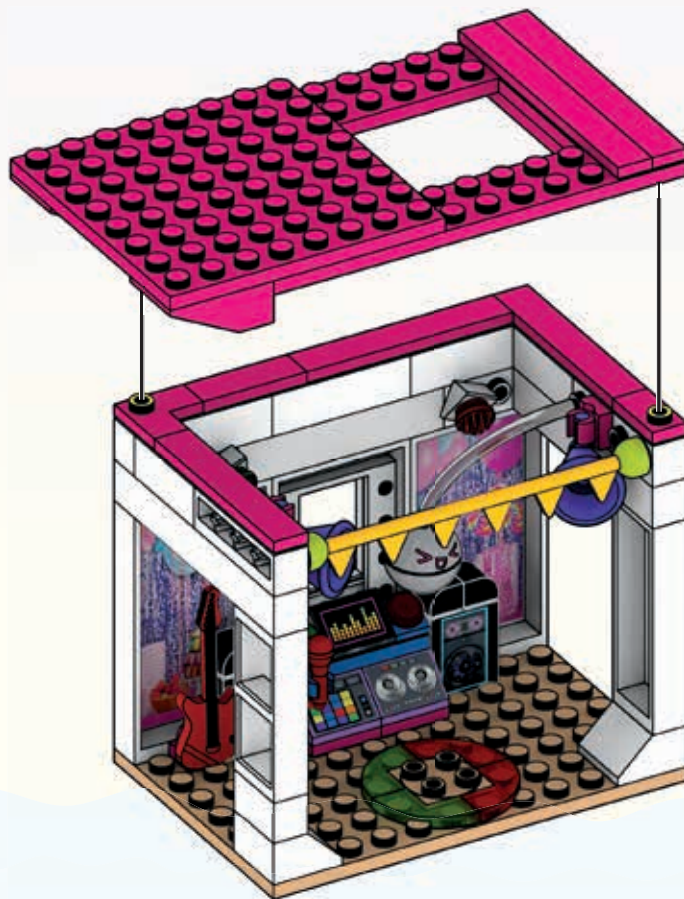

151





195

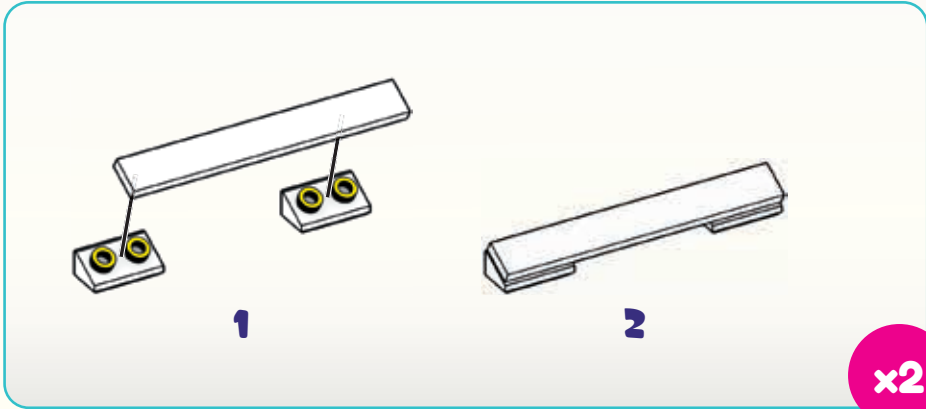
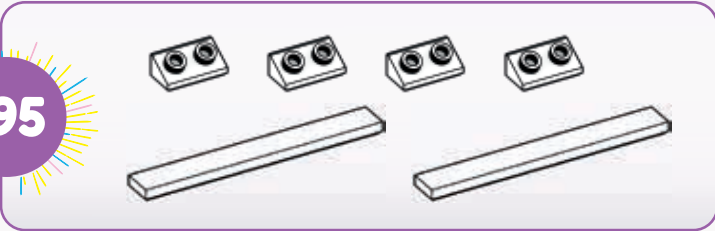

152



196



1

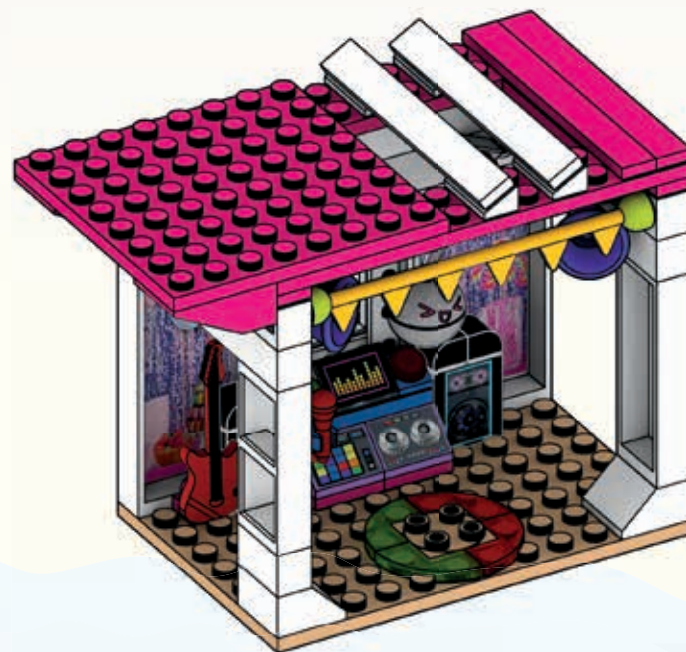

2



153





197

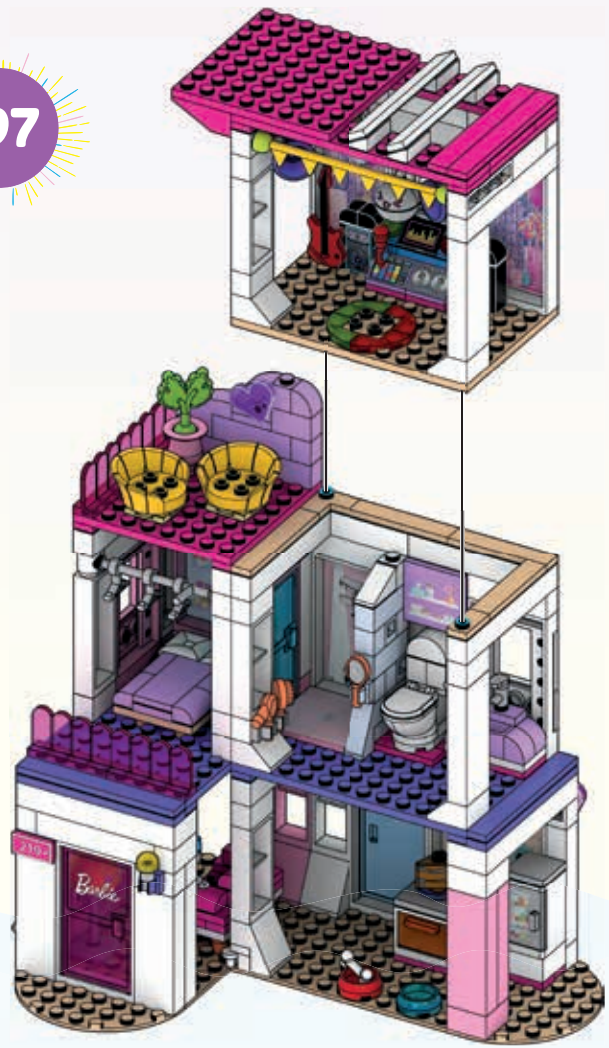

1



2

154





LET'S PLAY!
AMUSONS-NOUS!
 ¡AJUGAR! • A BRINGAR!
 LASS UNS SPIELEN! • НАЧИНАЕМ ИГРУ!





Let's Build The Elevator! Construisons l'ascenseur!

¡Vamos a construir el ascensor!
Vamos construir o elevador!
Den Aufzug bauen!
Построим лифт!



WHAT WILL YOU REVEAL? QU'ALLEZ-VOUS DÉCOUVRIR?

¿QUÉ VAS A REVELAR? • O QUE VOCÊ VAI REVELAR?
WELCHE PUPPE KOMMT ZUM VORSCHEN?
КАКУЮ КУКЛУ ВЫ ОТКРОЕТЕ?



1



2

**CUSTOMIZE YOUR
BARBIE® MICRO-DOLL!
PERSONNALISEZ VOTRE
MICRO-POUPÉE BARBIE®!**

¡PERSONALIZA TU MICROMUÑECA BARBIE®!
PERSONALIZE A SUA MICROBONECA BARBIE®!
DIE BARBIE MIKROPUPPE LÄSST SICH IMMER WIEDER NEU GESTALTEN!
СОЗДАЙТЕ СВОЮ МИКРОКУКЛУ БАРБИ®!



1

2

198

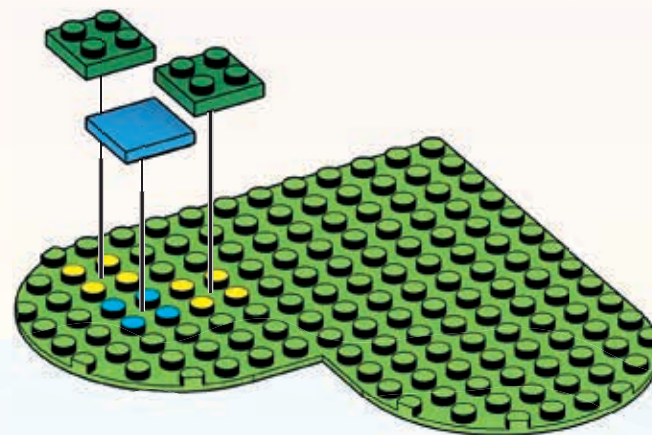
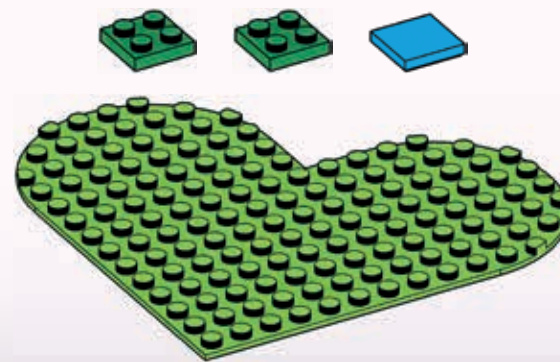

157



199



200

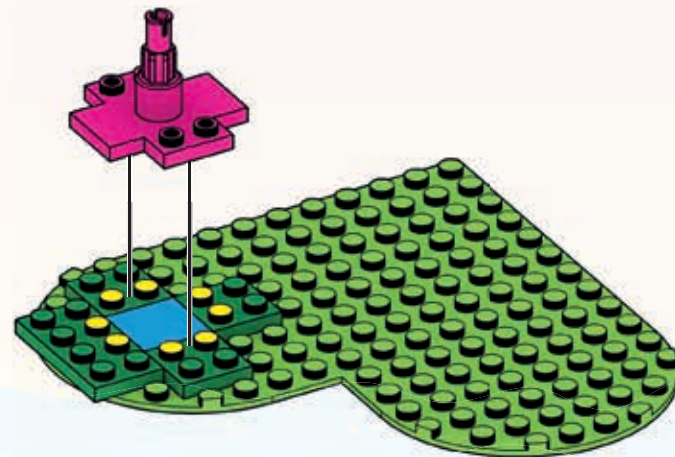
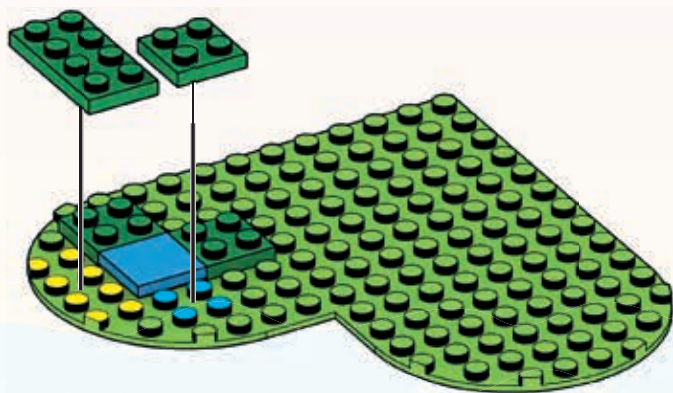



201

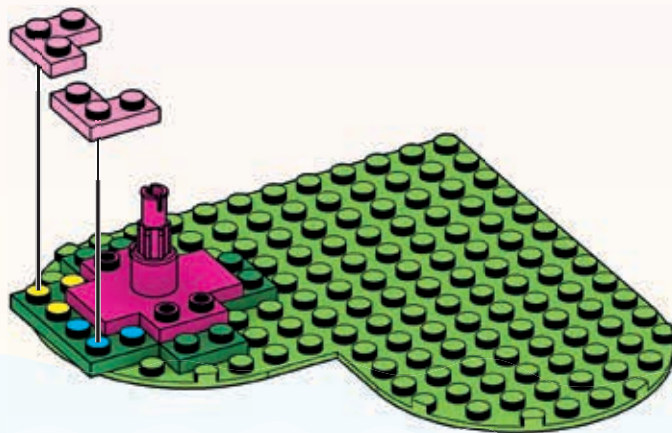

202

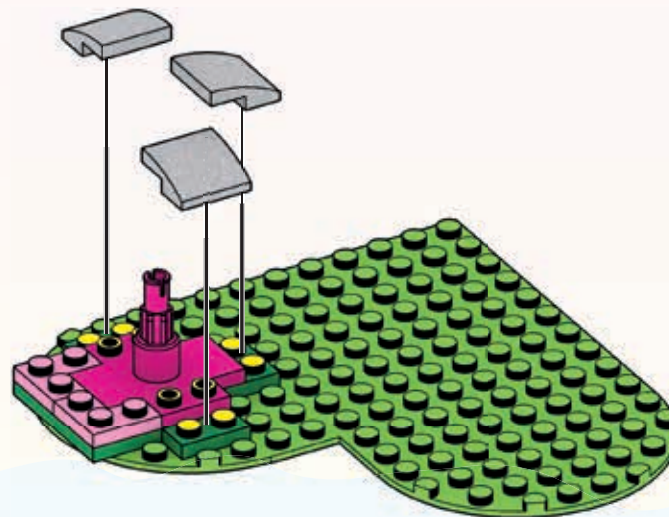



203

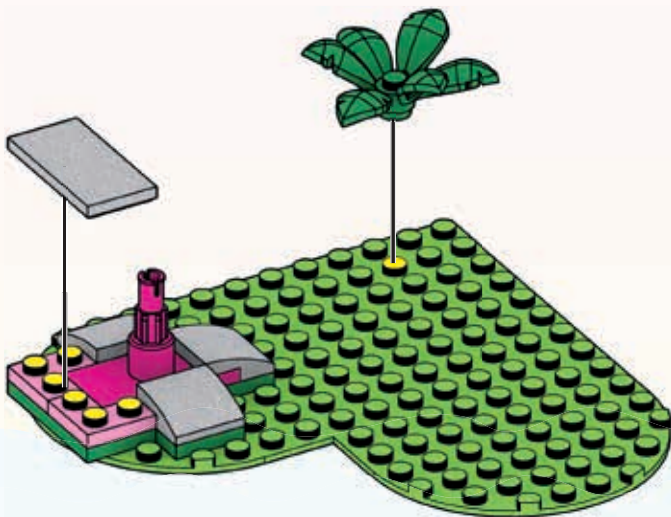

204

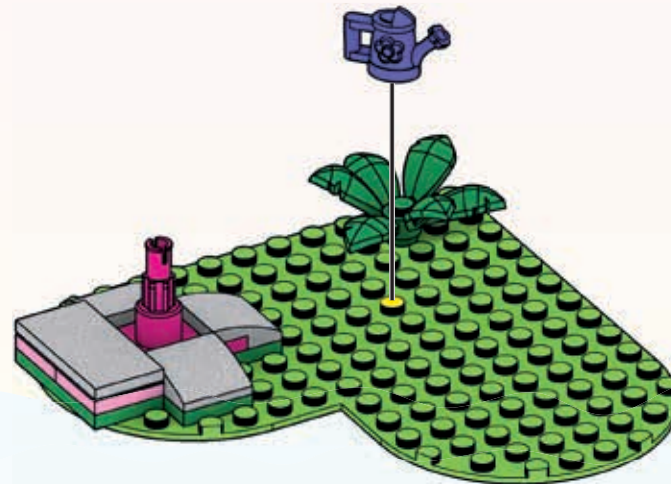



205

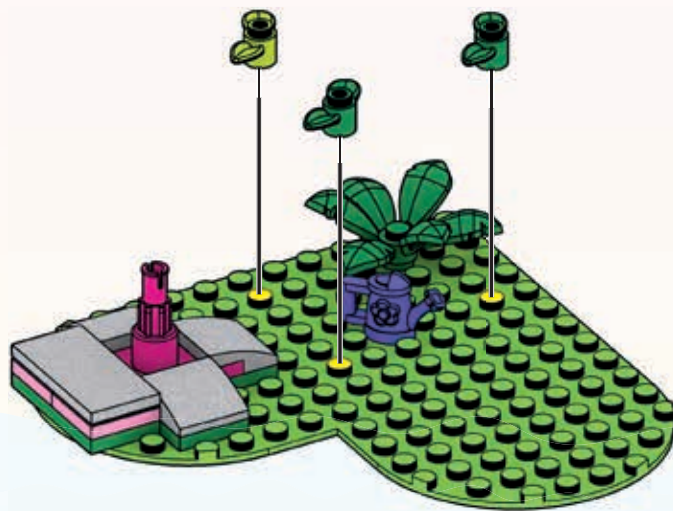

206

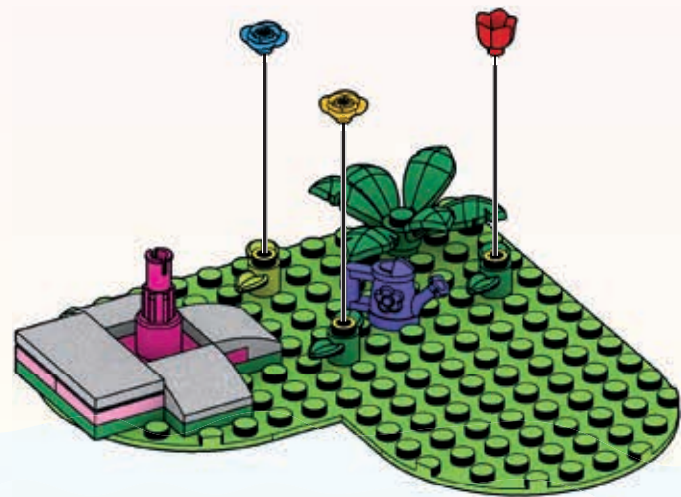



207

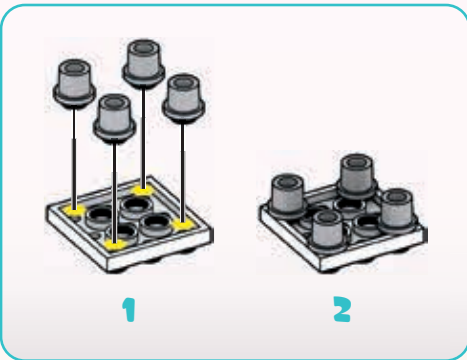

162





208

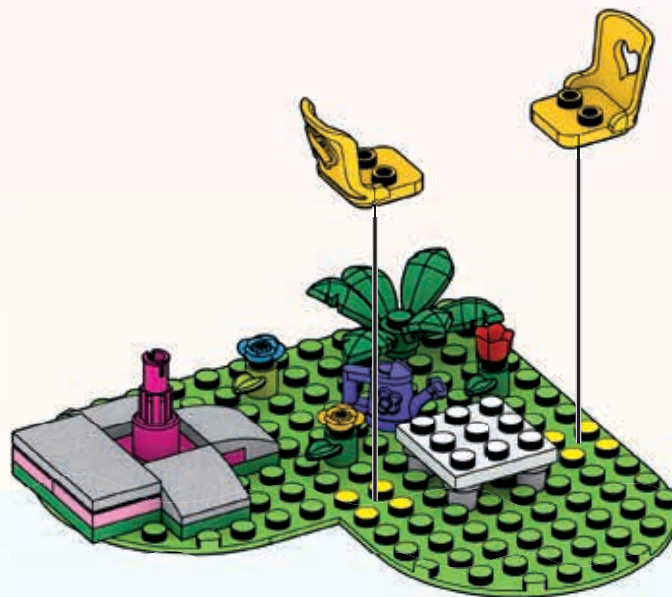

163





209

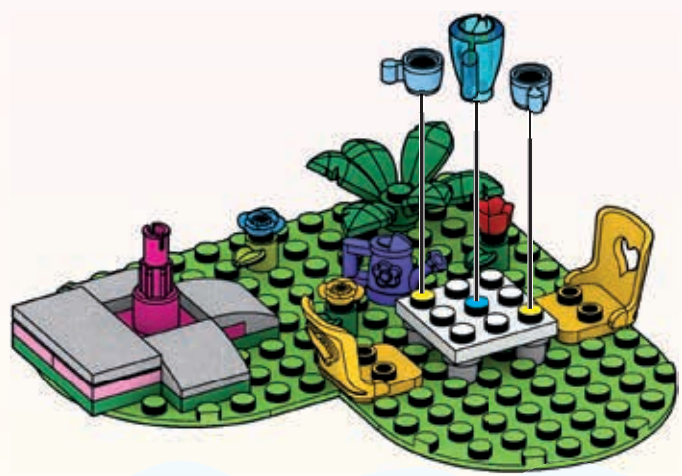

1



2

164





210

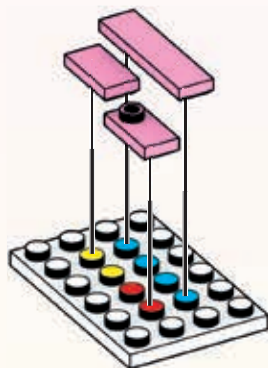

211

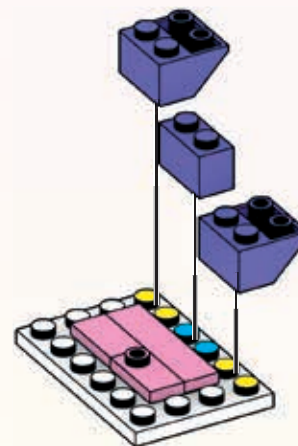



212

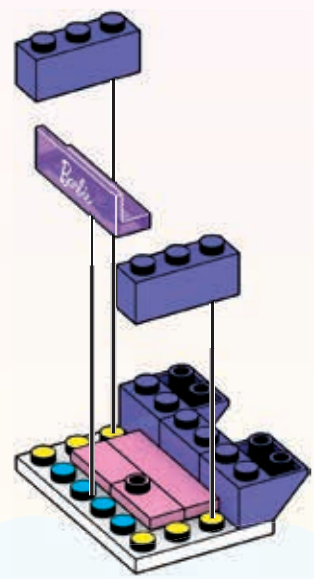

213

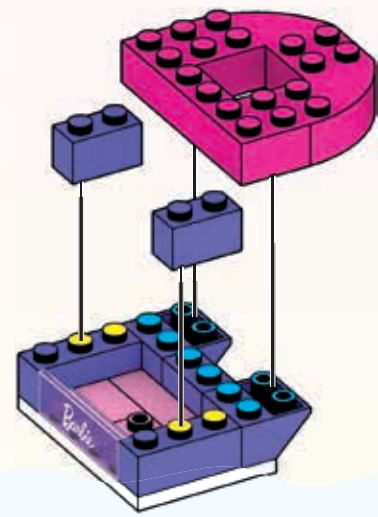
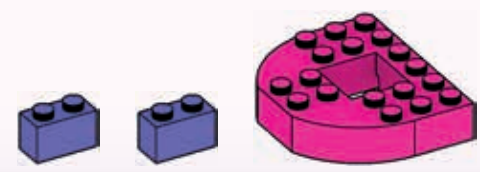



214

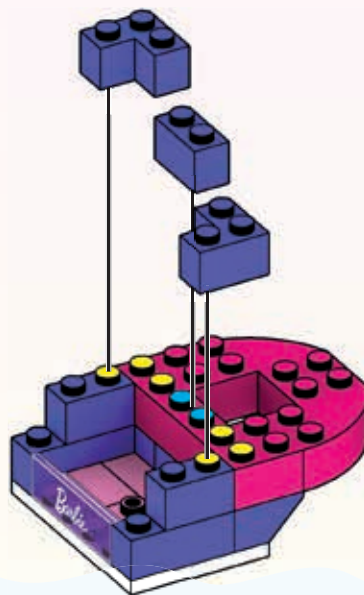

167



215

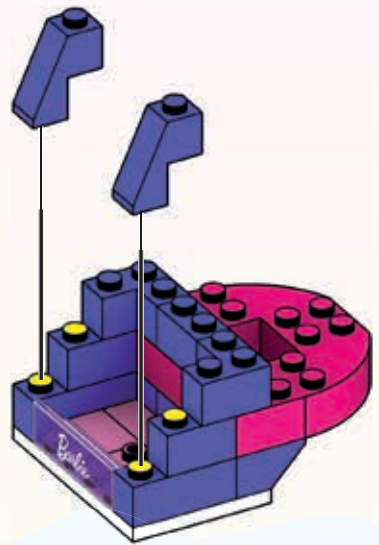
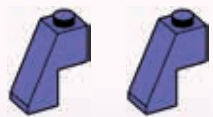

216

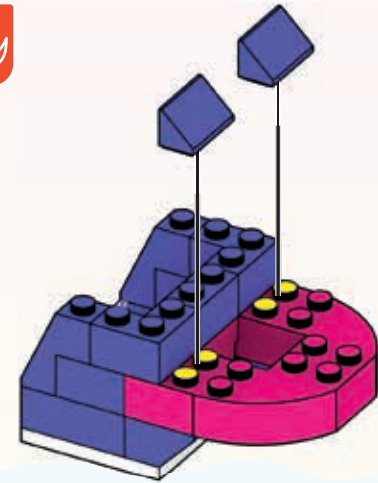



217

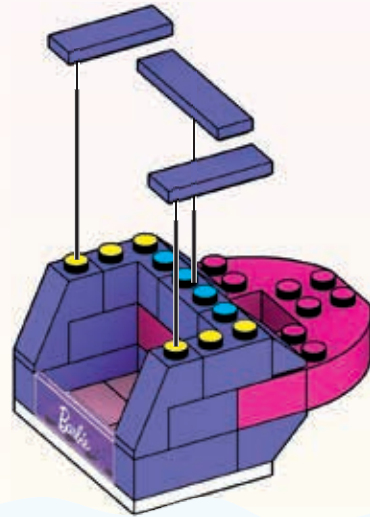

1

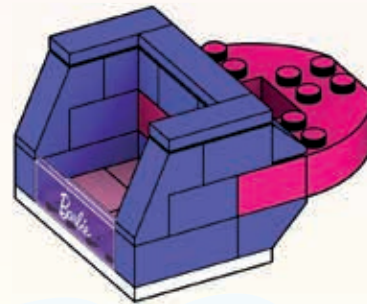

2





218

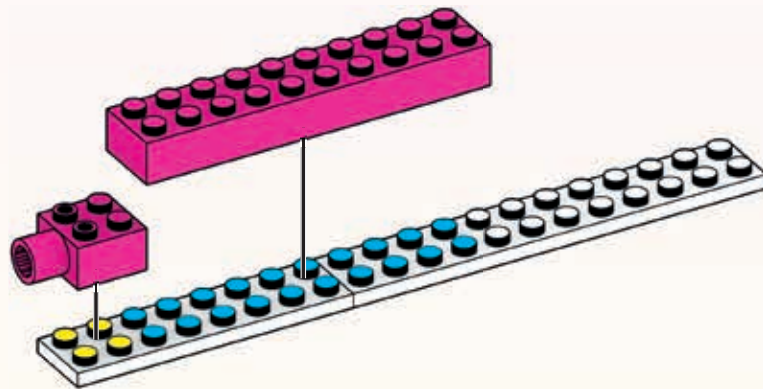

170





219

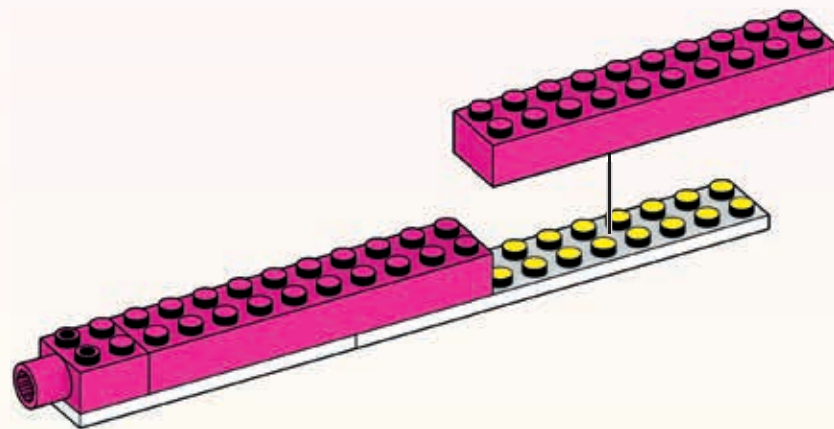
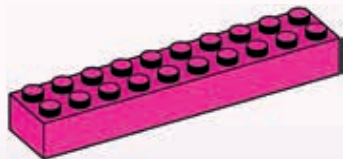



220

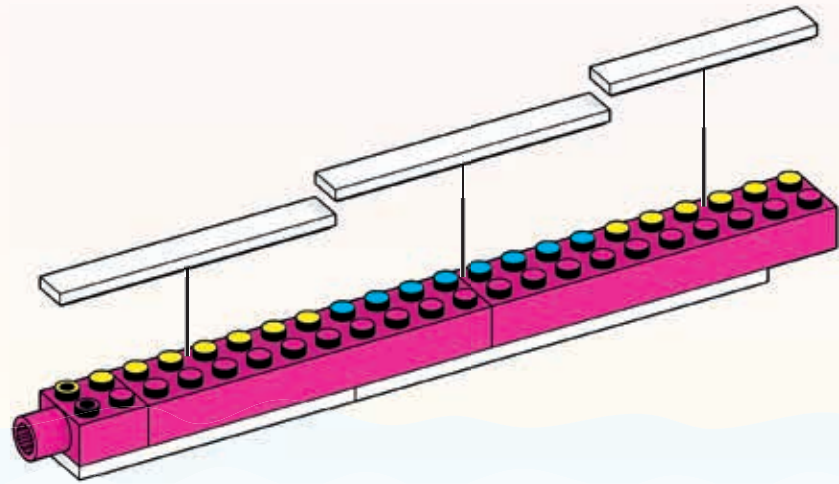
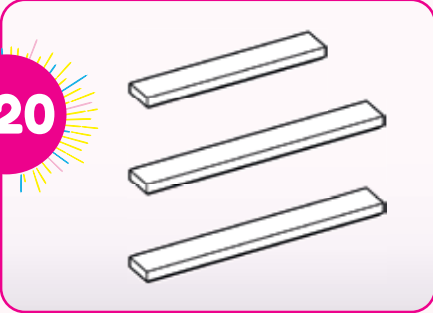

172



221

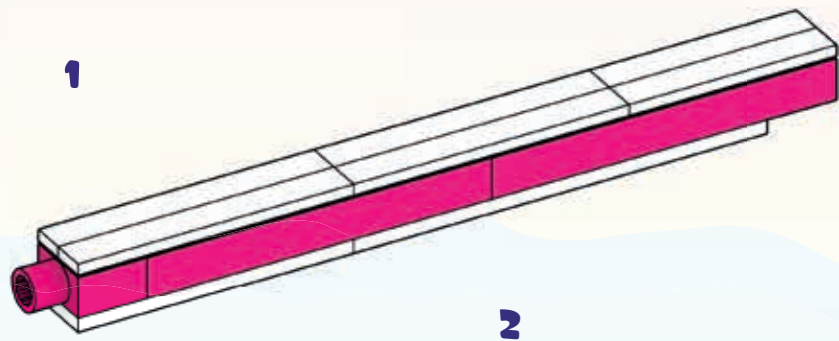
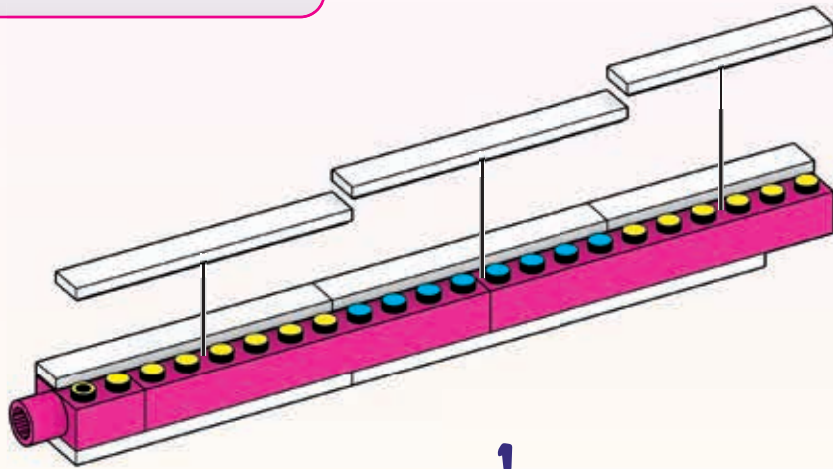
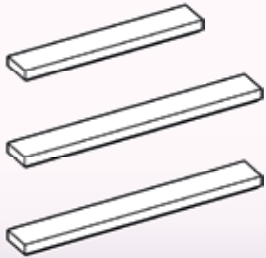

173





222

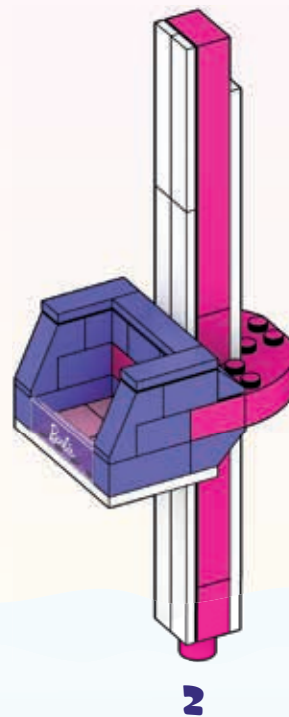
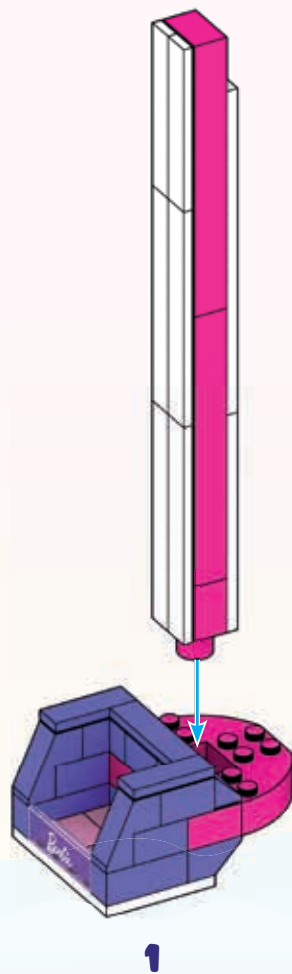

174





223

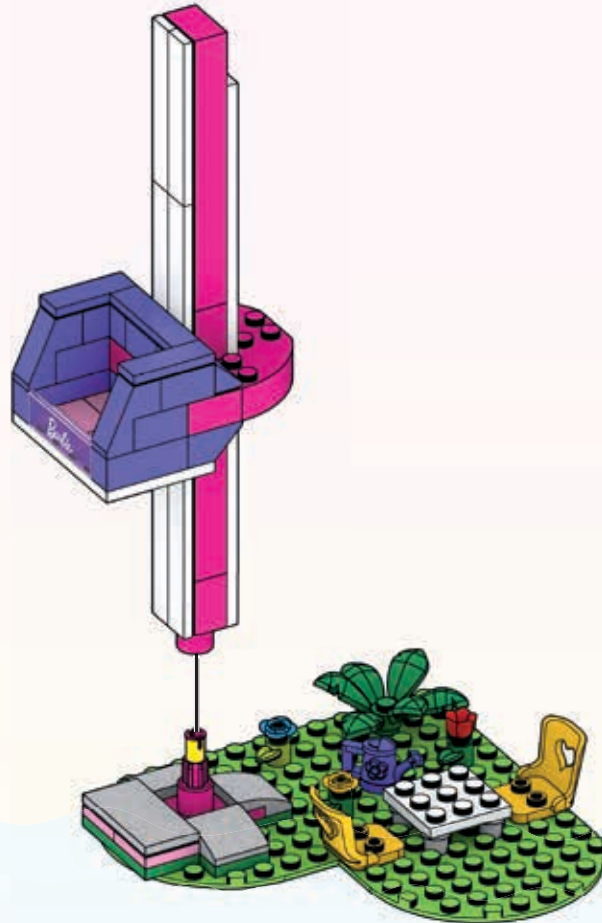

175





224

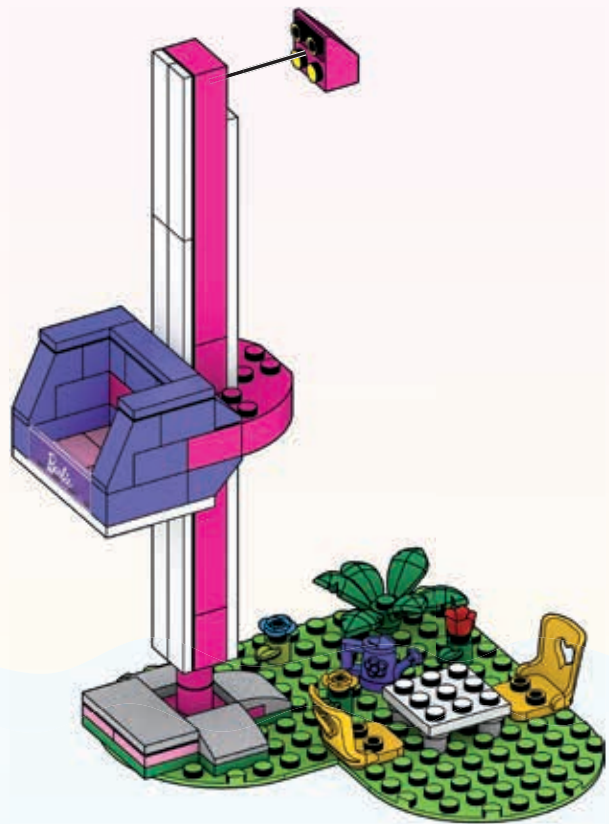

1

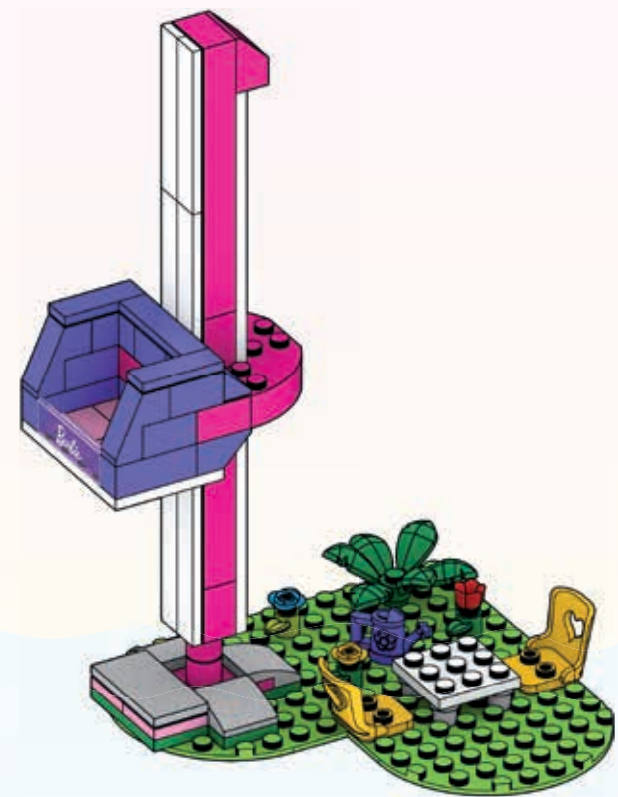

2



LET'S PLAY!
AMUSONS-NOUS!
¡AJUGAR! - A BRINGAR!
LASS UNS SPIELEN! • НАЧИНАЕМ ИГРУ!



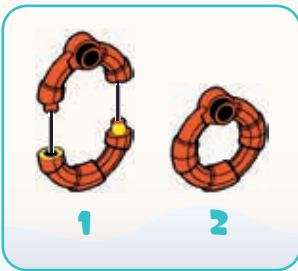



226

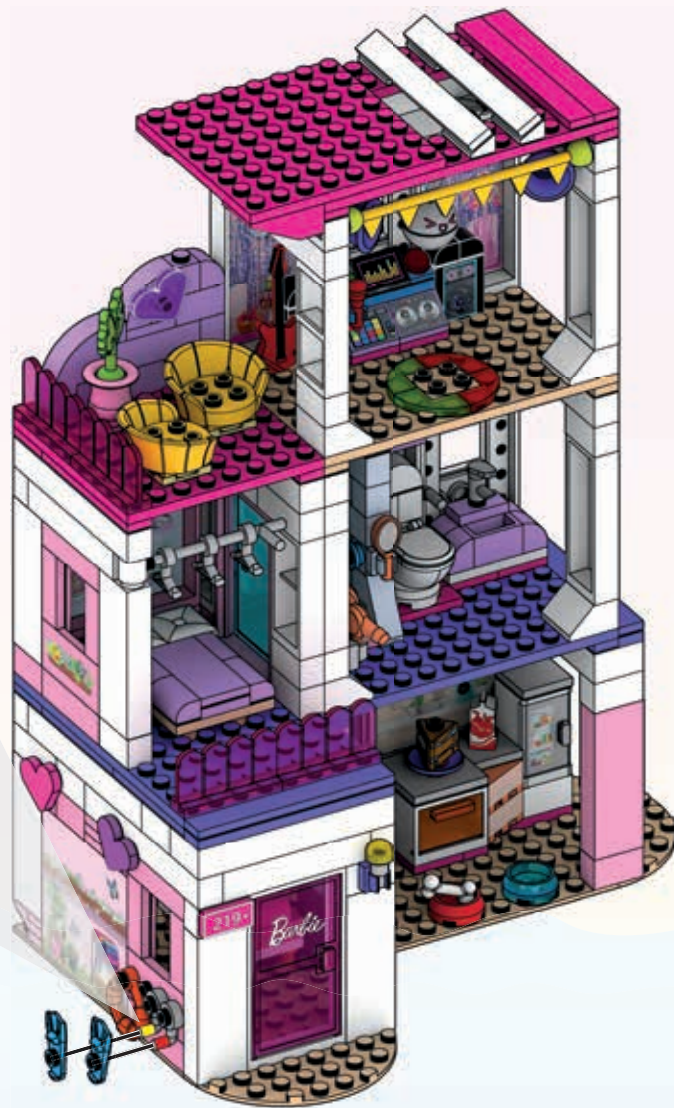
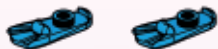

179





227

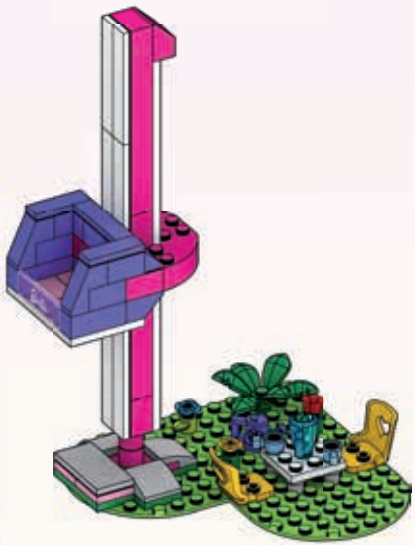
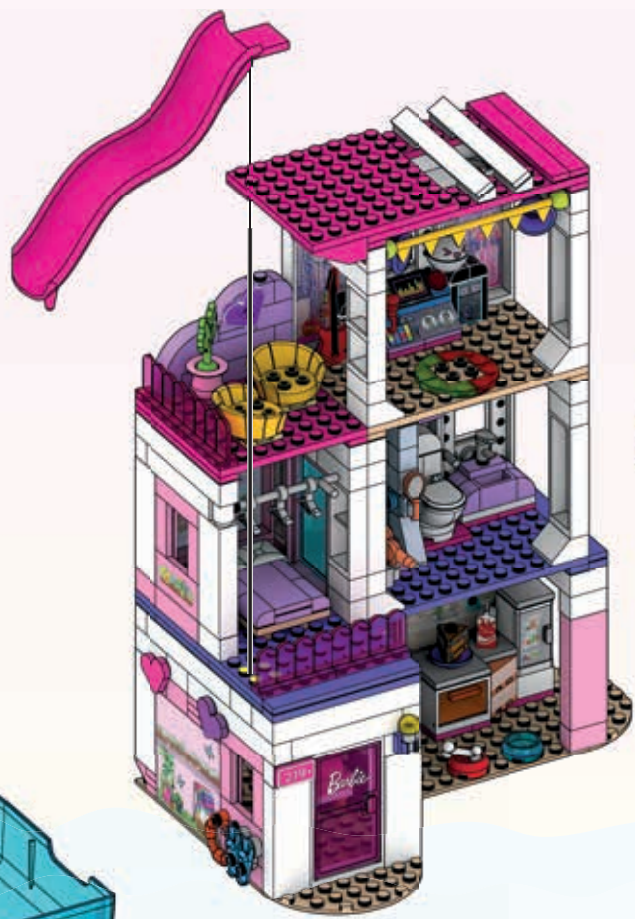

1

180



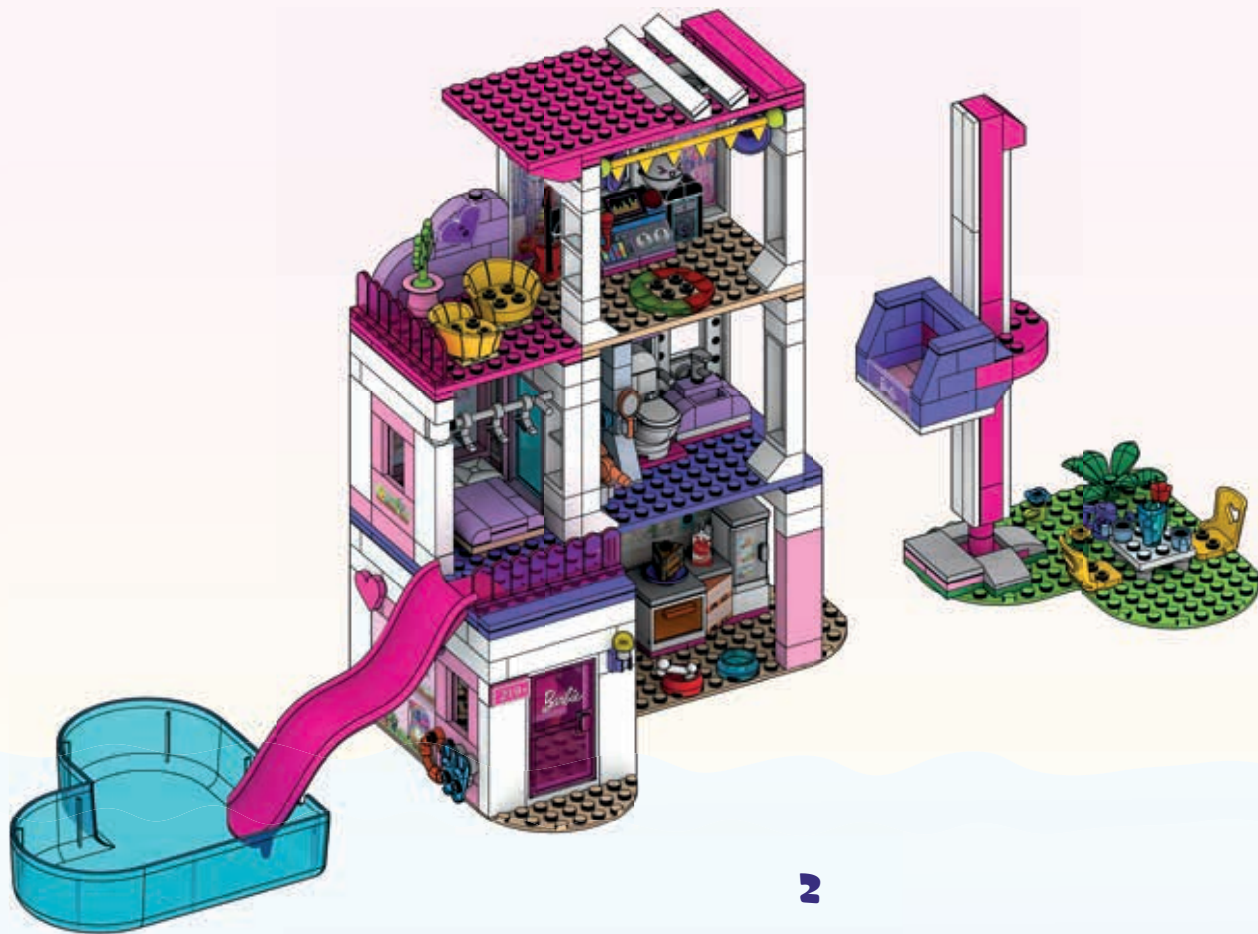

2



**CUSTOMIZE YOUR BARBIE® MICRO-DOLL!
PERSONNALISEZ VOTRE MICRO-POUPÉE BARBIE®!**

¡PERSONALIZA TU MICROMUÑECA BARBIE®! • PERSONALIZE A SUA MICROBONECA BARBIE®!
DIE BARBIE MIKROPUPPE LÄSST SICH IMMER WIEDER NEU GESTALTEN! • СОЗДАЙТЕ СВОЮ МИКРОКУКЛУ BARBIE®!





228



229

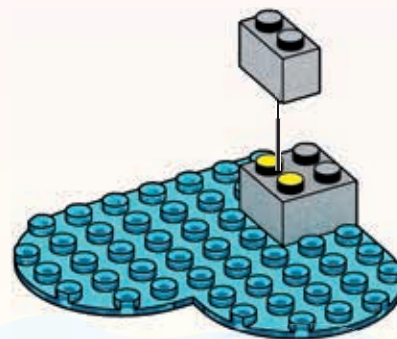
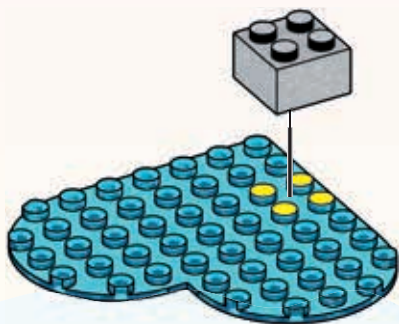



230

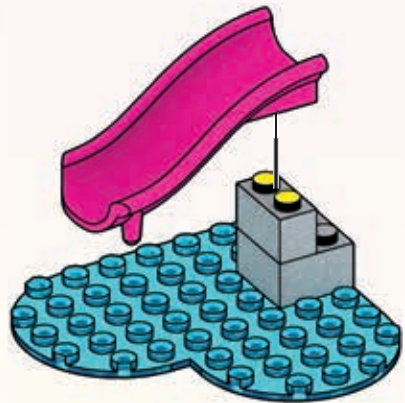
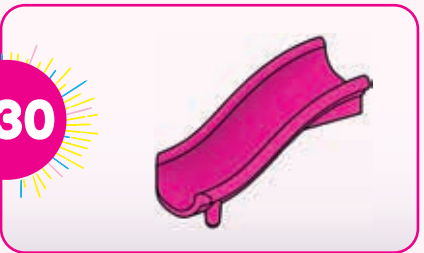

1

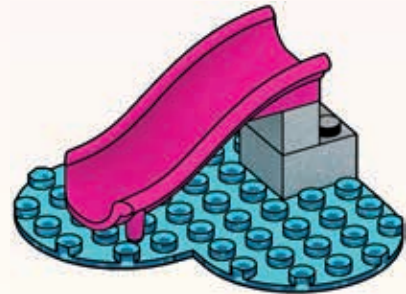

2





231

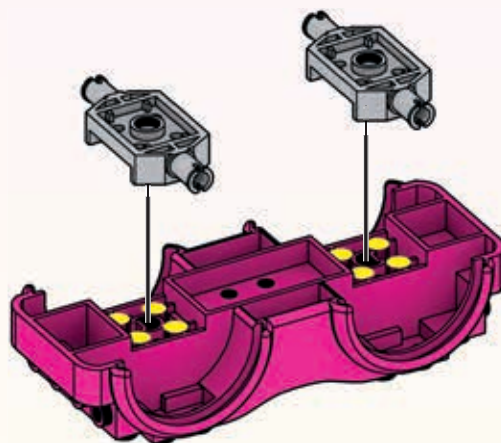
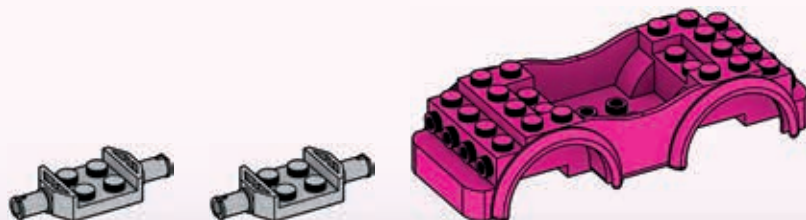

1

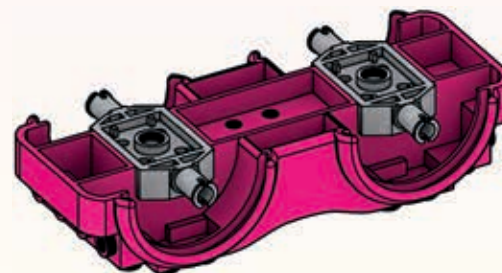

2





232

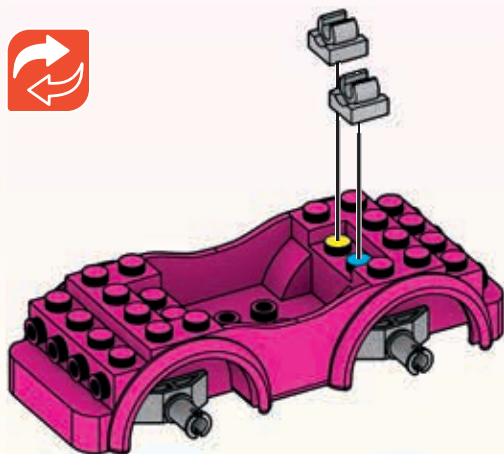

233





234



235

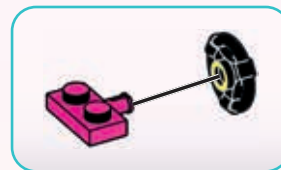



236



237

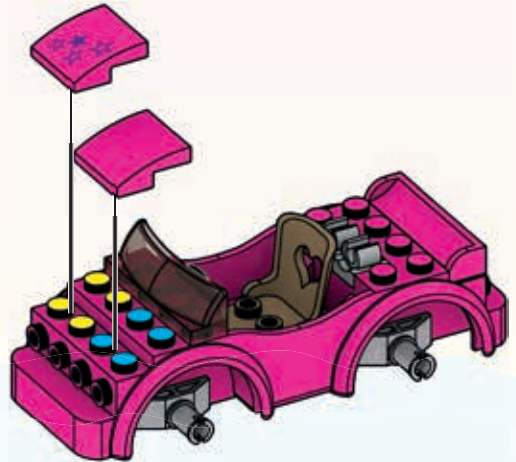

188





238

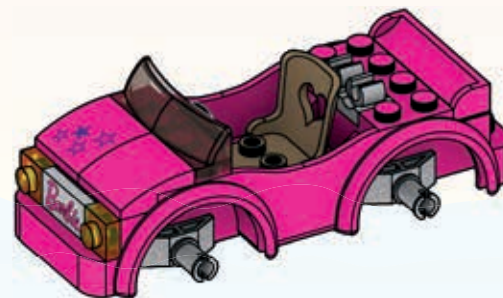



239

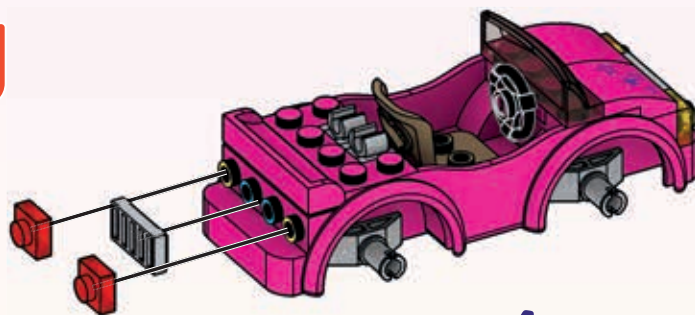

1

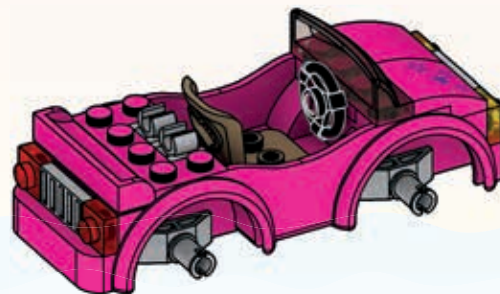

2





240

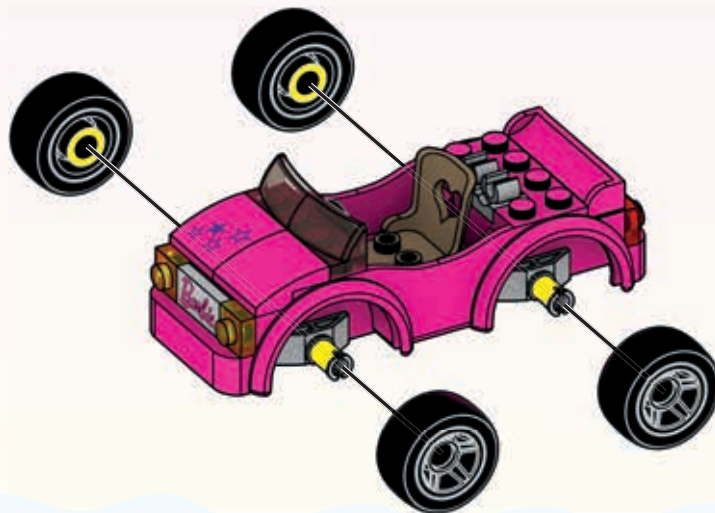



241

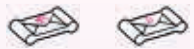

1

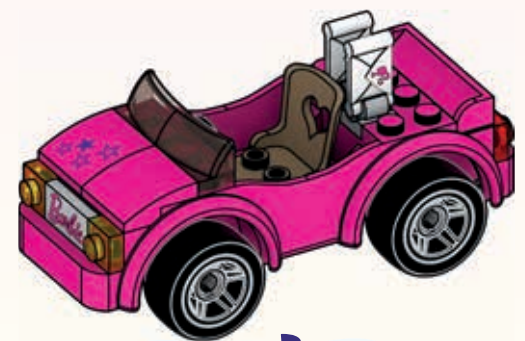

2





242



1



2



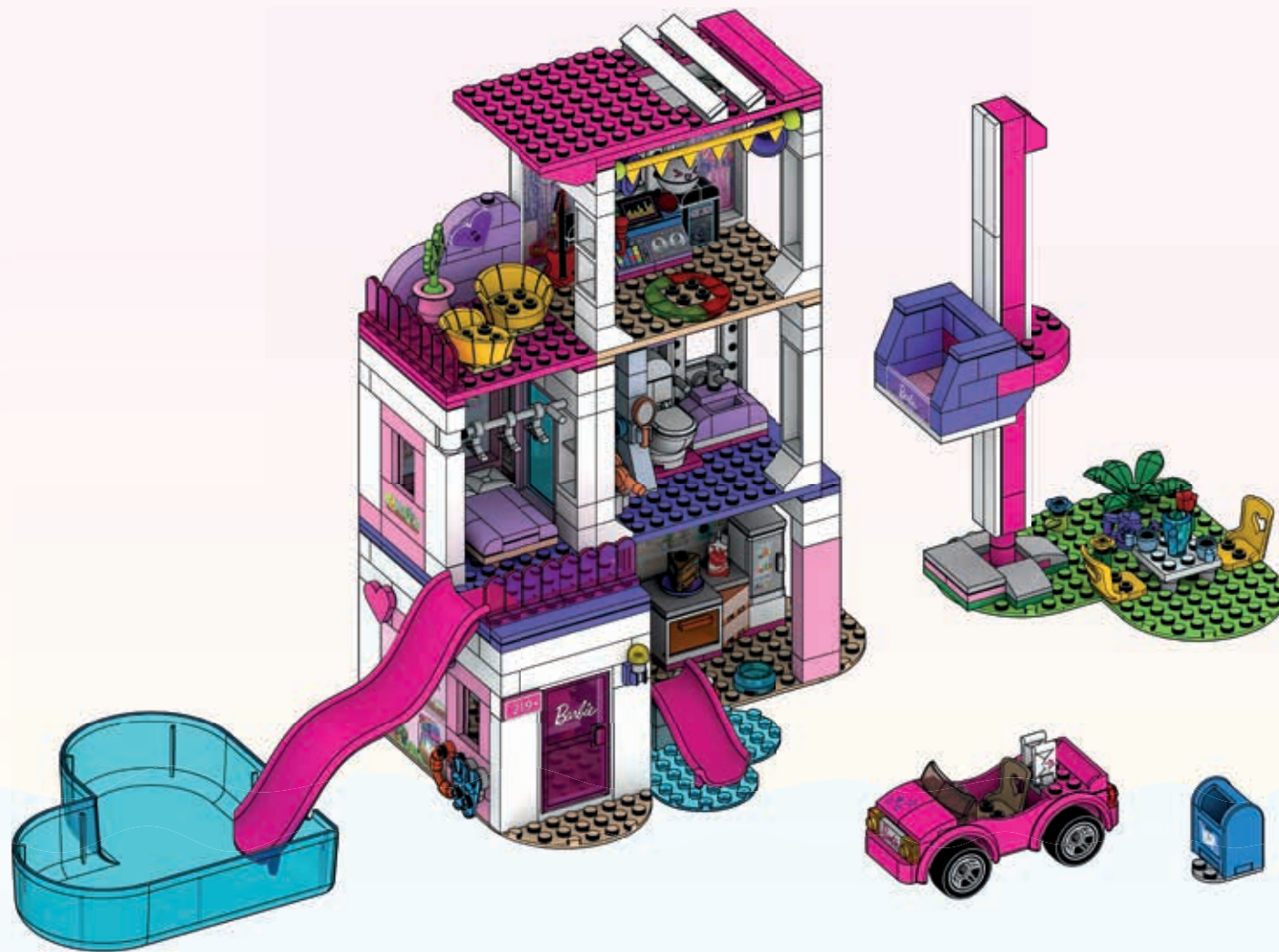

LET'S PLAY!
AMUSONS-NOUS!
¡AJUGAR! - A BRINGAR!
LASS UNS SPIELEN! • НАЧИНАЕМ ИГРУ!



Rebuild the house of your dreams! Construisez et reconstruisez la maison de vos rêves !

¡Reconstruye la casa de tus sueños! • Constrói a casa dos teus sonhos!
Ein Haus wie aus Träumen bauen! • Постройте дом своей мечты!

A



B



C



Most models can be built one at a time. / La plupart des modèles peuvent être construits un à la fois. / La mayoría de modelos se pueden construir de uno en uno. / A maioria dos modelos pode ser construída separadamente. / La maggior parte dei modelli possono essere realizzati uno per volta. / Die meisten Modelle können eines nach dem anderen gebaut werden. / Większości modeli nie da się budować jednocześnie z innymi. / De meeste modellen kunnen één voor één gebouwd worden. / Большинство моделей могут быть собраны по одной за раз. / De fleste modeller kan bygges enkeltvis. / De flesta modeller kan byggas en i taget. / De fleste modellene kan bygges en om gangen. / Useimmat mallit voidaan rakentaa yksi kerrallaan. / Τα περισσότερα μοντέλα μπορούν να κατασκευασθούν ένα ένα. / Modellerin çoğu ayrı ayrı inşa edilmeyi gerektirebilir. / Většinou lze najednou sestavit pouze jeden model. / Väčšina modelov môže byť zostavená iba raz. / A modellek többségéből egyszerre csak egy építhető. / ほとんどのモデルは、一度に一つを組み立てることができます。 / يمكن تركيب التصاميم الواحد تلو الآخر. / 大多數型號可一次性建構

A



1

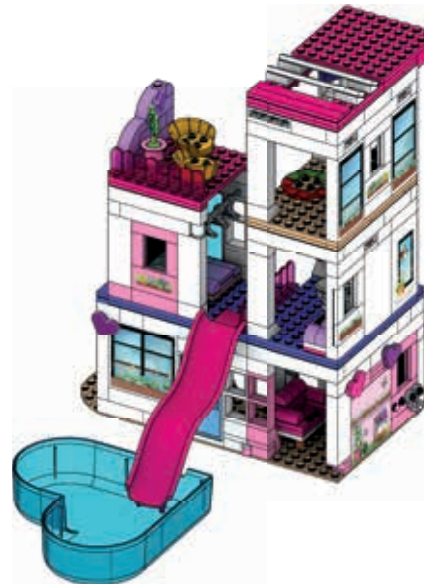

2



B

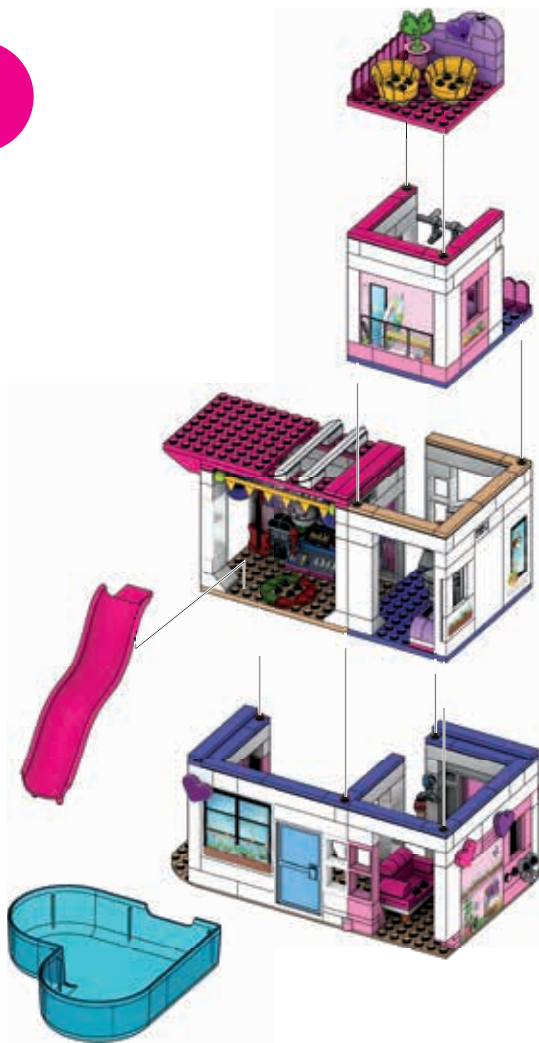

1



2





C



1



2



1x AM75332X	2x AM03328ASX	2x AM72001HP	1x AM80722E	4x AM81164APG	1x AS-HHM01-06	1x AS-HHM01-08	2x AM09393E	2x AM03017GW	1x AM81095NL
1x AM75332WH	2x AM03328X	2x AM72001E	5x AM07659NL	4x AM81164AMR	1x AM72980AAD	1x AM022501ASX	1x AM09393NL	4x AM03017NL	4x AM09013AMP
1x AM18560AMC	2x AM03328ZD	1x AM19999AMP	2x AM01086NL	4x AM81164AAD	1x AM72980AAD	1x AS-HHM01-07	1x AM18221ATC	2x AM03019AMP	1x AM09013APG
1x AM18560GX	1x AM03328GX	5x AM19999APG	1x AM01086E	2x AM79638I	1x AS-HHM01-10	1x AM09198APG	4x AM18272E	1x AM03019W	1x AM09013AAA
1x AM08417WH	1x AM03328E	1x AM19999AAA	3x AM01086AAA	1x AM19158AMR	1x AM18591HP	2x AM73758AMP	1x AM72002ASX	1x AM04430E	5x AM17502E
1x AM08417X	1x AM16980AMC	3x AM19999ATC	3x AM07629E	1x AM74397APG	1x AM19413MCX	3x AM73758ATC	1x AM77723APG	1x AM17834E	2x AM74672AAD
1x AM78219ZD	3x AM17787GW	2x AM79570APG	1x AM07629NL	1x AM73012AMR	1x AM19649MCX	1x AM73758ASX	1x AS-HHM01-09	1x AM18601E	2x AM78726BMG
2x AM78802BBG	4x AM17787F	1x AM72973E	1x AM07629NL	1x AM73012AMR	4x AM81245APG	1x AM73758AMR	1x AM72972AMC	12x AM09013E	2x AM73433GX
1x AM76558ZD	1x AM72953AMC	1x AS-HHM01-02	2x AM07629AAA	1x AM73158AXW	1x AS-HHM01-01	1x AM07590NL	1x AM72972AAV	1x AM09013ASX	1x AM78726BBG
2x AM79666F	1x AM72954BYE	1x AS-HHM01-03	1x AM18286AAA	2x AM72931APG	4x AS-HHM01-29	3x AM09393ASX	1x AM76559ASX	2x AM09013NL	1x AM17342AMP
1x AM72954GX	1x AM19392GX	1x AM74414AMP	2x AM17507ASX			2x AM09393GW	2x AM76560E		
1x AM73014RQ	3x AM19392APG	1x AM81383F							

1x AM73980GW
 1x AM73980AEN
 1x AM73980AHZ
 1x AM73980KF
 2x AM74428AMP
 7x AM74428ATC
 1x AM74428AMR
 2x AM15484ASX
 1x AM72000ASX
 1x AM73009APG
 2x AM0948APG
 1x AM0948GX

2x AM72956E
 3x AM03773BMG
 1x AS-HHM01-28
 2x AS-HHM01-27
 3x AM74106APG
 1x AM74106ATC
 1x AS-HHM01-19
 2x AM03872F
 1x AM03872AAD
 1x AS-HHM01-04

2x AM01154AMP
 1x AM01154ATC
 2x AM17153E
 3x AM17153ASX
 2x AM17153AMP
 1x AM09023E
 1x AM09023APG
 4x AM10273E
 2x AM10273NL

2x AM18667X
 2x AM18667WH
 2x AM80966AMP
 4x AM80966E
 4x AM80966ASX
 4x AM80966ATC
 1x AM80966GW
 1x AM01314E
 1x AM01314HP
 3x AM74298GW
 1x AM74298ATC

1x AM18328F
 2x AM03772E
 5x AM16384E
 1x AM16384GW
 3x AM16384AAA
 2x AM16384AMP
 2x AM01139ATC
 1x AM18593APG
 1x AM72439APG

1x AM72982AAD
 1x AM73030AAV
 1x AM73186ASX
 2x AM76026AMP
 1x AM16682NL
 2x AM18658AMP
 1x AM18658AAA
 1x AM73740HT

1x AM78490ATC
 1x AM18562ASX
 2x AM18562E
 2x AM81142BYE
 1x AM81142ASE
 1x AM72257NL
 2x AM73960BYE

1x AM81364BLG
 1x AM18615APG
 1x AM81163E
 1x AM18615NL
 1x AM72025F
 8x AM01087E
 1x AM01087NL
 1x AM01087ASX
 2x AM17503E

1x
AS-HHM01-18



1x
AM09593ATC



1x
AM09838ATC



1x
AM09838ASX



1x
AM09838AMP



1x
AM09921ATC



1x
AM07475GW



6x
AM17793AMP



1x
AM17793ATC



3x
AM17793AMR



1x
AM77463NL



1x
AM77463ASX



1x
AM77463APG



2x
AM77463E



1x
AM01531ASX



1x
AM09493NL



2x
AM09493E



1x
AM09493BMG



2x
AM09493ATC



2x
AM81137APG



1x
AM81086AMD



1x
AS-HHM01-25



1x
AS-HHM01-24



1x
AS-HHM01-05



1x
AS-HHM01-26



1x
X-HHP89-01



1x
AM79290ASX



5x
AM79290E



1x
AM81496ASX

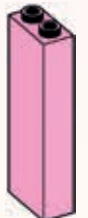

8x
AM81496E



2x
AM16289E



1x
AM16289ASX



4x
AM17330AUZ



1x
AM78728ASX



1x
AM72901BMG



1x
AM73235ATC



1x
AM73144AXW



14x
AM09292E



2x
AM09292ATC



2x
AM16331AMP



5x
AM16331ATC



2x
AM16331E



1x
AM18524APG



1x
AM16331AMR



1x
AM79604W



1x
AS-HHM01-11



1x
AM09239E



1x
AS-HHM01-14





1x
AS-HHM01-13



1x
AS-HHM01-22

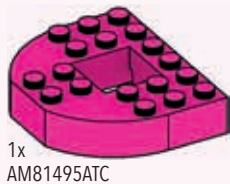

1x
AM81495ATC



1x
AS-HHM01-16

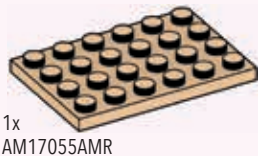

1x
AM17055AMR



1x
AM17055E

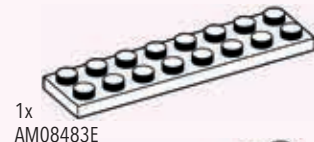

1x
AM08483E



12x
AM10233E



2x
AM04984E

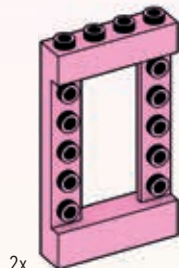

2x
AM80908ASX



1x
AS-HHM01-23



1x
AS-HHM01-12



1x
AM01313NL

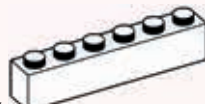

7x
AM01313E



1x
AM81162BYE



2x
AM09922AMP

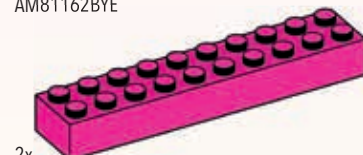

2x
AM04985ATC

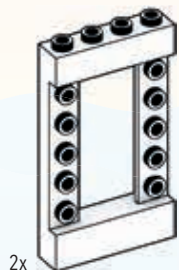

2x
AM80908E



1x
AS-HHM01-17



1x
AS-HHM01-15



6x
AM09922E

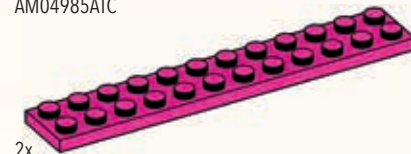

2x
AM01172ATC



2x
AM09922ATC

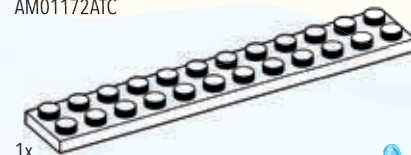

1x
AM01172E



2x
AM18298AMP



2x
AM18556ATC

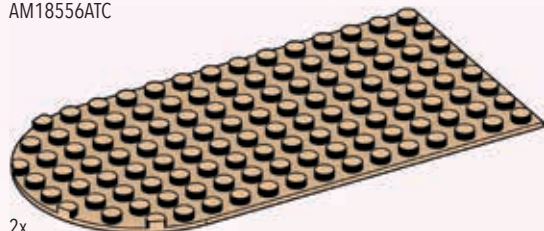

2x
AM81106AMR



1x
AM81105ATC

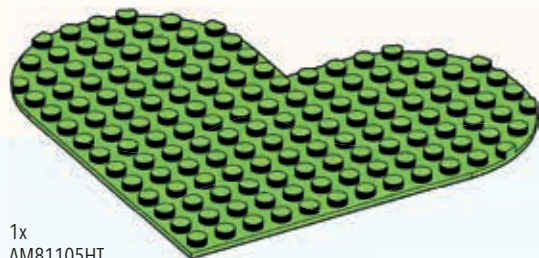

1x
AM81105HT



1x
AM81553ATC



1x
AM80855MCX

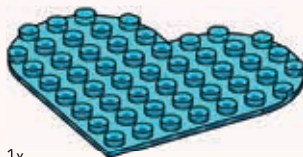

1x
AM81104AAV

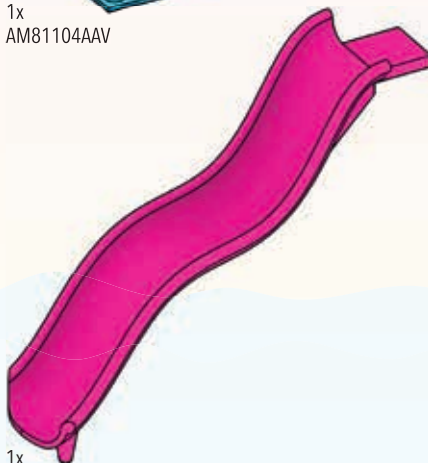

1x
AM81497ATC



1x
AM81085ATC

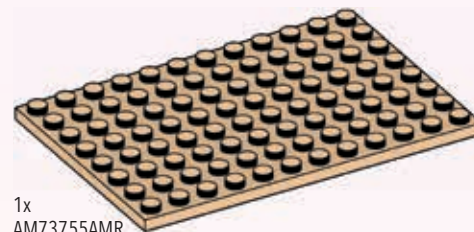

1x
AM73755AMR

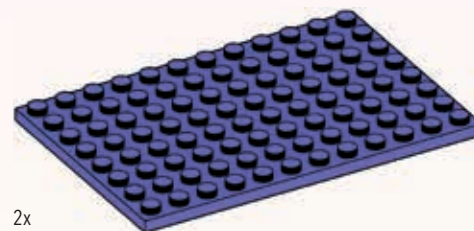

2x
AM73755AMP

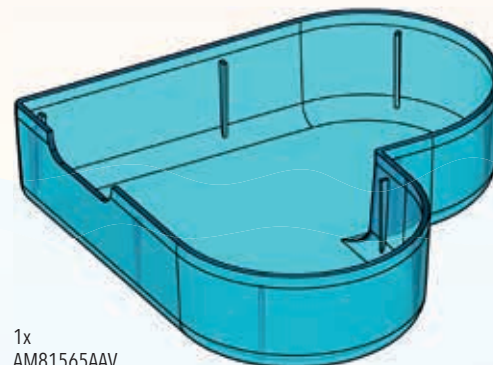

1x
AM81565AAV





1x
FIG-HHM01-A



1x
FIG-HHM01-E



1x
FIG-HHM01-B



1x
FIG-HHM01-C



1x
FIG-HHM01-D



1x
AM81370ASX



1x
AM81370HT



1x
AM81121MCX



1x
AM81120NL



1x
AM81125FM



1x
AM81124AAD

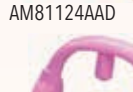

1x
AM81372ASX

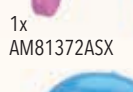

1x
AS-HHM01-21



1x
AS-HHM01-20



1x
FIG-HHM01-F



1x
FIG-HHM01-G



1x
FIG-HHM01-H

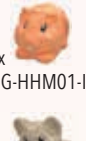

1x
FIG-HHM01-I



1x
FIG-HHM01-J



1x
FIG-HHM01-K



1x
AL-HHM01-01A



Missing pieces? • Pièces manquantes?

¿Partes faltantes? • Perdeu peças?
Fehlen Teile? • Не хватает деталей?

support.megabrands.com

Color change will last longer if you do not expose this toy to intense heat or direct sunlight for prolonged periods of time. Le changement de couleur peut tenir plus longtemps si vous n'exposez pas ce jouet à une chaleur intense ou à la lumière directe du soleil pendant de longues durées. / El cambio de color durará más tiempo

si no expone este juguete al calor intenso o a la luz solar directa durante períodos de tiempo largos. / A mudança de cor durará mais se você não expor este brinquedo ao calor intenso ou à luz solar direta por períodos prolongados. / L'effetto cambia colore durerà più a lungo se questo giocattolo non viene esposto al calore intenso o alla luce diretta del sole per periodi di tempo prolungati. / Die Farbveränderung ist nachhaltiger, wenn das Spielzeug nicht über einen längeren Zeitraum hinweg starker Hitze oder direkter Sonneneinstrahlung ausgesetzt wird. / Zmiana koloru będzie trwała, jeśli zabawka nie będzie długookresowo narażana na wysoką temperaturę lub bezpośrednie działanie promieni słonecznych. / De verandering van kleur gaat langer mee als je dit speelgoed niet voor langere tijd aan intense hitte of direct zonlicht blootstelt. / Цвет будет дольше оставаться без изменений, если вы не будете подвергать эту игрушку продолжительному и сильному воздействию тепла или прямого солнечного света. / Fargeændringen vil vare længere, hvis du ikke udsætter legetøjet for intens varme eller direkte sollys i længere perioder. / Färgändringen varar längre om du inte utsätter leksaken för stark värme eller direkt solljus under längre tidsperioder. / Fargeændringen vil vare lenger hvis du ikke utsetter denne leken for sterk varme eller direkte sollys over lengre tid. / Värimuutos kestävä pidempään, jos et altista tätä lelua voimakkaalle kuumuudelle tai suoralle auringonvalolle pitkiä aikoja. / Η αλλαγή χρώματος θα διαρκέσει περισσότερο εάν δεν εκθέτετε αυτό το παιχνίδι σε έντονη ζέση ή άμεσο ηλιακό φως για παρατεταμένες χρονικές περιόδους. / Bu oyuncuğu uzun süre yoğun ısıya veya doğrudan güneş ışığına bırakmadığınız sürece, renk değişimi uzun sürecektir. / Změna barvy vydrží déle, pokud tato hračka nebude delší dobu vystavena intenzivnímu teplu nebo přímému slunečnímu záření. / Zmena farby vydrží dlhšie, ak túto hračku nebudete dlhší čas vystavovať intenzívnemu teplu alebo priamemu slnečnému žiareniu. / A színváltozás tovább tart, ha nem teszi ki ezt a játékot hosszú ideig erős hő vagy közvetlen napfény hatásának. / 色変化は本玩具を長時間にわたり猛烈な暑さや直射日光にさらさなければより長く持続します。

تغيير لون يديم طويلاً في حال تجنب تعرض هذه اللعبة لدرجات الحرارة العالية أو ضوء الشمس المباشر لفترات زمنية طويلة. 如果玩具能避免长时间暴露于高温或阳光直射下，变色的有效时间会更长。

To avoid burns do not use water that is too hot, above 43°C (110°F). Water toys sometimes get messy. Protect play surfaces before use. Drain, rinse, clean and dry all items thoroughly before storing. Dissolvable paint may stain fabrics and other surfaces. Avoid contact with carpet, clothing, wall and furniture. If staining occurs, raise with soap (not included) and warm water. Pour éviter tout risque de brûlure, n'utilisez pas d'eau trop chaude (plus de 43 °C). Les jouets d'eau peuvent éclabousser. Protégez les surfaces de jeu avant toute utilisation. Égouttez, rincez, lavez et séchez tous les éléments minutieusement avant de les ranger. La peinture soluble peut tacher certains tissus et autres surfaces. Évitez tout contact avec la moquette, les vêtements, les murs et les meubles. En cas de tache, rincez au savon (non inclus) et à l'eau tiède.

Para evitar quemaduras, no utilizar agua demasiado caliente (por encima de 43 °C). Los juguetes que requieren agua pueden ensuciar la superficie de juego. Se debe proteger antes de empezar a jugar. Es necesario limpiar, aclarar y secar todas las piezas antes de guardar el juguete. La pintura disolvente puede manchar o adherirse a algunos tejidos y otras superficies. Se recomienda evitar el contacto con alfombras, moqueta, ropa, paredes y muebles. Si se producen manchas, lavar con jabón (no incluido) y agua templada.

Para evitar quemaduras, não utilizar água demasiado quente, acima dos 43 °C. Os brinquedos que requerem a utilização de água podem sujar a área de brincadeira. Proteger a área de brincadeira antes de brincar. Lavar, enxaguar, limpar e secar bem todos os acessórios antes de guardar. A tinta dissolúvel pode manchar os tecidos e outras superfícies. Evitar o contacto com tapetes, roupa, paredes e mobília. Se provocar manchas, enxaguar com sabão (não incluído) e água morna.

Per prevenire le ustioni, non usare acqua troppo calda, oltre 43°C. I giochi ad acqua possono creare disordine. Proteggere le superfici di gioco prima dell'utilizzo. Svuotare, risciacquare, pulire e asciugare accuratamente tutte le componenti prima di riporle. La vernice solubile può macchiare tessuti e altre superfici. Evitare il contatto con tappeti, abiti, pareti e mobili. In caso di macchie, risciacquare con sapone (non incluso) e acqua calda.

Um Verbrennungen zu vermeiden, kein Wasser benutzen, das zu heiß ist (über 43°C). Wasserspielzeuge können spritzen! Die Spielfläche vor dem Spielen abdecken. Nicht auf Oberflächen spielen, die durch Wasser Schaden nehmen können. Alle Spielteile vor dem Weglegen gründlich säubern und trocknen. Die lösliche Farbe kann auf einigen Stoffen und anderen Oberflächen Flecken hinterlassen. Nicht mit Teppich, Kleidung, Wänden oder Möbeln in Berührung bringen. Etwaige Flecken mit warmem Wasser und Seife (nicht enthalten) auswaschen.

Aby uniknąć oparzeń, nie używaj zbyt gorącej wody (o temperaturze powyżej 43°C). Zabawki, którymi można bawić się przy użyciu wody, mogą powodować nieporządek. Przed rozpoczęciem zabawy z bezpieczną przeznaczoną do niej powierzchnią. Opróżnij z wody, oplucz, oczyść i wysusz wszystkie części zabawki przed ich schowaniem. Rozpuszczalna farba może plamić tkaniny i inne powierzchnie. Unikaj kontaktu z dywanami, odzieżą, ścianami i meblami. W przypadku wystąpienia zabrudzeń spłucz je ciepłą wodą z mydłem (nie znajduje się w zestawie).

Gebruik, om brandwonden te voorkomen, geen water warmer dan 43°C. Bij het spelen met water kan er nogal eens wat nat worden. Dek voor het spelen het speelgedeelte goed af. Voor het opbergen alle onderdelen leeg laten lopen, schoonspoelen en goed afdrogen. Oplosbare verf kan vlekken veroorzaken op stoffen en andere oppervlakken. Vermijd contact met tapijt, kleding, wanden en meubels. Als ergens vlekken in komen, spoel je deze af met zeep (niet meegeleverd) en warm water.

Во избежание ожогов не используйте слишком горячую воду, температура которой превышает 43°C. Игрушки, предназначенные для игр с водой, иногда становятся причиной беспорядка. Перед началом игры подготовьте все необходимое для защиты поверхностей игровой зоны. Перед тем как убрать изделия на хранение, ополосните, почистите и протрите их насухо. Растворимая краска может оставить пятна на тканях и других поверхностях.

Избегайте контакта с коврами, одеждой, стенами и мебелью. Если пятна появились, очистите их в теплой воде при помощи мыла (не входит в комплект).

Undgå forbrændinger ved ikke at bruge vand, der er over 43 °C. Når man leger med vandlegetøj, kan legeområdet blive vådt. Beskyt legeområdet inden brug af legetøjet. Tøm, skyl, rengør og tør alle dele grundigt, inden de lægges væk. Opløselig farve kan efterlade pletter på stof og andre overflader. Undgå kontakt med tæpper, tøj, vægge og møbler. Skyl efter med varmt sæbevand (medfølger ikke), hvis der kommer pletter.

Undvik brännskador, använd inte vatten som är varmare än 43°C. Vattenleksaker kan orsaka spill. Skydda underlaget före lek. Töm, skölj, tvätta och torka alla delar innan du lägger undan dem för förvaring. Vattenlöslig färg kan ge fläckar på tyger och andra material. Undvik kontakt med mattor, tyger, väggar och möbler. Om fläckar uppstår, skölj med tvål (ingår inte) och varmt vatten.

For å unngå forbrenninger må du ikke bruke vann som er varmere enn 43 °C. Vannleker kan medføre mye søl. Skytt lekeflatene for bruk. Tøm, skyl, rengjør og tørk alle delene grundig før oppbevaring. Den oppløselige malingen kan lage flekker på stoff og andre overflater. Unngå kontakt med tepper, klær, vegger og møbler. Hvis det blir flekker, skyller du med såpe (medfølger ikke) og varmt vann. Vältäta palovammoja – älä käyttää liian kuumaa vettä (yli 43 °C). Vesileikeistä saattaa syntyä sotkuja. Suojaa leikkipaikka ennen leikin aloitusta. Tyhjennä, huuhto, puhdistajaa ja kuivaa kaikki osat hyvin ennen kuin panet ne säilöön. Maali voi tahrata kankaista ja muita materiaaleja. Varo, ettei sitä joudu matolle, vaatteille, seinille eikä huonekaluille. Poista tarvittaessa tahrat saippualla ja lämpimällä vedellä.

Για να αποφύγετε εγκαύματα μη χρησιμοποιείτε πολύ ζεστό νερό άνω των 43°C. Κάποιες φορές τα παιχνίδια με νερό προκαλούν ακαταστασία. Προστατέψτε την επιφάνεια του παιχνιδιού πριν από τη χρήση. Καθαρίστε και στεγνώστε καλά όλα τα αντικείμενα πριν την αποθήκευσή τους. Η διαλυτή μπογιά μπορεί να λερωθεί υφάσματα και άλλες επιφάνειες. Αποφύγετε την επαφή με χαλί, ρούχα, τοίχους και έπιπλα. Αν γίνει λεκές, καθαρίστε τον με ζεστό νερό και σαπούνι (δεν περιλαμβάνεται).

Yanma riskini önlemek için ürünü 43°C'den yüksek sıcaklıkta su ile kullananmayın. Suyula oynanan oyuncaklar etraflı islatılabilir. Oyuncaya kullanmadan önce oyun alanını ıslanmaya karşı koruyun. Oyun setini kaldırmadan önce tüm parçalarını suyunu süzün, parçaları durulayın, temizleyin ve kurutun. Çözünür boyalar, kumaşları ve diğer yüzeyleri lekeleyebilir. Ürünü halı, giysi, duvar ve mobilyalara temas ettirmeyin. Lekelenen yüzeyi sabun (ürüne dahil değildir) ve ılık suyla temizleyin.

Nepoužívejte příliš horkou vodu (o teplotě vyšší než 43 °C), abyste předešli opaření. Hračky na vodu mohou způsobit nepořádek. Před použitím zakryjte povrchy, kde si budete hrát. Před uložením všechny předměty opláchněte, vyčistěte, nechte je okapat a důkladně vyschnout. Rozpustná barva může zanechat skvrny na tkaninách a jiných površích. Zabraňte kontaktu s koberci, oděvy, stěnami a nábytkem. Skvrny od barvy odstraníte opláchnutím teplou vodou s mýdlem (není součástí balení).

Nepoužívejte príliš horúcu vodu s teplotou nad 43°C (110°F), aby sa predišlo popáleniu. Hračky do vody občas spôsobia neporiadok. Pred použitím zabezpečte hraciu plochu pred poškodením. Pred uložením všetky diely dôkladne vyprázdňte, opláchnite, očistite a vysušte. Rozpustná farba môže zafarbiť textilie a iné povrchy. Zamedzte kontaktu s kobercom, odevom, stenami a nábytkom. V prípade znečistenia opláchnite mydlom (nie je súčasťou balenia) a teplou vodou.

Az égési sérülések elkerülése érdekében a víz ne legyen nagyon forró, hőmérséklete ne haladja meg a 43°C fokot. A vízi játékokkal játszó gyerekek kisebb-nagyobb rendeltenséget okozhatnak. Használat előtt gondoskodjon a játszófelület védelméről. Törölés előtt ürítse ki, öblítse le, tisztítsa meg és hagyja teljesen megszáradni a játék minden részét. A feloldódó festék elszínezheti a szöveteket és más felületeket. Lehetőleg ne érjen hozzá szőnyeghez, ruházathoz, falhoz és bútorokhoz. Ha foltot hagyta, öblítse le szappannal (nem tartozék) és meleg vízzel.

やけどしないように、43度以上の熱すぎないお湯をご使用ください。水を使用したおもちゃは周囲を汚す可能性があります。周囲をぬらさないように注意し、使用後は水道水で洗いタオルでふいて乾かしてください。色素が周囲を汚す可能性があります。カーペット、衣服、壁や家具などにつかないようにしてください。汚れがついたらすぐに洗剤をとかしたぬるま湯でふいてください。

يجب عدم استخدام الماء الساخن جداً الذي تتجاوز حرارته 43 درجة مئوية (110 فهرنهايت) لتفادي حدوث حروق.

أحياناً، قد تسبب الألعاب المائية بعض الفوضى. يجب تأمين ساحات اللعب قبل الاستخدام. يجب تصفية كافة قطع الألعاب وتجفيفها وشطفها وتنظيفها قبل تخزينها. تترك ألوان الطلاء بقعاً على الأنسجة وغيرها من الأسطح. يجب تجنب ملامسة السجاد والملابس والحداد والأثاث. في حال حدوث البقع يجب الغسل بالماء الدافئ والصابون (غير متضمنة).

防止水溫太高導致燙傷，請不要使用溫度大於43攝氏度（110華氏度）的水。在水中玩耍的玩具通常較容易弄髒。請在玩耍前好好保护玩具表层。在存储玩具之前请将玩具中的水彻底排开，进行清洗以及烘干。可溶解的涂层可能会弄脏纺织物品或者其他物体的表面。防止与地毯，衣物，墙壁以及家具接触。如果发生弄脏的情况，请用肥皂（产品不包含）以及温水进行清洗。

ATTENTION : DANGER
D'ÉTOUFFEMENT - PRÉSENCE DE PETITS ÉLÉMENTS.
LE JOUET CONTIENT DES PETITES BALLE(S). NE
CONVIENT PAS AUX ENFANTS DE MOINS DE 3 ANS.

ATENÇÃO! NÃO INDICADO / NÃO
RECOMENDÁVEL PARA CRIANÇAS MENORES DE 3
(TRÊS) ANOS POR CONTER PARTE(S) PEQUENA(S) /
BOLA(S) PEQUENA(S) QUE PODE(M) SER ENGOLIDA(S)
OU ASPIRADA(S) SENDO PROVOCAR ASFIXIA.

تحذير:
ليست مناسبة للأطفال دون سن 36 شهراً - قطع صغيرة.
كرات صغيرة. خطر الاختناق.

警告!

本产品内含小零件和小
球，可能产生窒息危险，
不适合3岁以下儿童使用。

⚠ WARNING: CHOKING HAZARD. - Small parts. Toy
contains small balls. Not for children under 3 years.
ADVERTENCIA: PELIGRO DE ATRAGANTAMIENTO. Juguete
no recomendado para menores de 3 años, porque contiene
piezas pequeñas / bolitas que podrían provocar asfixia en
caso de ser ingeridas o inhaladas por el/la niño/a.



AVVERTENZA: Piccole parti. Piccole palle. Rischio di soffocamento.
ACHTUNG: Kleine Teile. Kleine Kugeln. Erstickungsgefahr.
OSTRZEŻENIE: Małe części. Małe kuleczki. Niebezpieczeństwo zadławienia.
WAARSCHUWING: Kleine onderdelen. Kleine balletjes. Verstikkingsgevaar.
ПРЕДУПРЕЖДЕНИЕ: Мелкие детали. Маленькие шарики. Опасность
проглатывания. / **ADVARSEL:** Små dele. Små bolde/kugler. Kvælningssfare.
VARNING: Smådelar. Små bollar. Kvävningssrisk.

ADVARSEL: Små deler. Små kuler. Kvelningsfare.
VAROITUS: Pieniä osia. Pieniä palloja. Tukehtumisvaara
ΠΡΟΣΟΧΗ: Μικρά κομμάτια. Μικρές μπάλλες. Κίνδυνος Πνιγμού.
UYARI: Küçük parçalar. Küçük toplar. Yutma tehlikesi.
UPOZORNENÍ: Malé díly. Malé micky. Nebezpečí udušení.
UPOZORNENIE: Malé casti. Malé guľôčky. Nebezpečenstvo zadusenía.

FIGYELMEZTETÉS: Kis alkatrészek. Kis labdák. Fulladásveszély.

警告:
のどにつまる危険 小さな部品が含まれています
小さな玉が含まれています。
3歳以下の子供には与えないで下さい。

*HHP86, HHP87, HHP88, HHW83

Set(s) sold separately and subject to availability. / Ensemble(s) vendu(s) séparément.

Certains produits peuvent ne pas être commercialisés. / Se vende(n) por separado y está(n) sujeto(s) a disponibilidad. / Conjunto(s) vendido(s) em separado e sujeito(s) à disponibilidade. / Set in vendita separatamente, secondo disponibilità. / Das/Die Set(s) sind separat erhältlich. / Zestaw(y) sprzedawany(e) oddzielnie w zależności od dostępności. / Set(s) apart verkrijgbaar en afhankelijk van beschikbaarheid. / Набор(-ы) продаются отдельно, при наличии. / Sæt sælges separat og så længe lager haves. / Setten sæljs separat så længe lagret rækker. / Settet/settene selges separat så langt lageret rekker. / Pakkaus/pakkaukset myydään erikseen, saatavuus voi vaihdella. / Το(α) σετ πωλούνται ξεχωριστά και ανάλογα με τη διαθεσιμότητα. / Setler ayrı olarak satılır ve stoklarla sınırlıdır. / Set (sety) se prodává (prodávají) samostatně dle aktuální nabídky. / Súprava/-y sa predáva(jú) samostatne a podľa dostupnosti. / A készlet(ek) külön kapható(k), az elérhetőség változhat. / セット商品は別売りになります。在庫状況は別途ご確認お願いします。 / **تنبيه المجموعة أو المجموعات على حدة وتخضع لتوافرها.** **بمجموعة واحدة أو بمجموعات على حدة وتخضع لتوافرها.** **每套单独发售，按供货情况决定。**

***HHW83** This toy does not float. / Ce jouet ne flotte pas. / Este juguete no flota. / Este brinquedo não flutua. / Questo giocattolo non galleggia. / Dieses Spielzeug schwimmt nicht. / Ta zabavka nie pływa i nie unosi się na wodzie. / Dit speelgoed kan niet drijven. / Эта игрушка не держится на воде. / Dette legetøj kan ikke flyde. / Leksaken flyter inte. / Denne leken flyter ikke. / Tämä lelu ei kellu. / Αυτό το παιχνίδι δεν επιπλέει. / Bu oyuncak suya yüzmeyez. / Tato hračka neplyve. / Tato hračka neplyva na vode. / A játék nem marad fenn a víz felszínén. / このおもちゃは水に浮かびません。 / هذه اللعبة لا تطفو على الماء. **本产品不会漂浮于水面。**

Mattel Europa B.V., Gondel 1, 1186 JM Amstelveen, Nederland. Mattel U.K. Limited, The Porter Building, 1 Brunel Way, Slough SL1 1FQ, UK. Mattel France, Parc de la Cerisaie, 1/3/5 allée des Fleurs, 94260 Fresnes Cedex. N° Cristal 0969 36 99 99 (Numéro non surtaxé) ou www.lesjouetsmattel.fr Mattel Belgium, Trade Mart, Atomiumsquare, Bogota 202 - B 275, 1020 Brussels. Gratis nummer België: 0800 - 16 936 - Gratis nummer Luxembourg: 800 - 22 784 - Gratis nummer Nederland: 0800 - 262 88 35. Deutschland : Mattel GmbH, Solmsstraße 83, D-60486 Frankfurt am Main. Schweiz: Mattel AG, Kirchstrasse 24, CH-3097 Liebefeld. Österreich: Mattel Ges.m.b.H., Campus 21, Liebermannstraße A01 404, A- 2345 Brunn/Gebirge. Mattel Italy Srl, Via Turati 4, 20121 Milano, Italy. Servizio assistenza clienti: Customersrv.italia@mattel.com - Numero verde 800 111 37 11. Mattel España, S.A., Aribau 200 pl. 9, 08036 Barcelona. cservice.spain@mattel.com Tel.: +34 933 06 79 00 http://www.service.mattel.com/es. Mattel East Asia Ltd., Room 503-09, North Tower, World Finance Centre, Harbour City, Tsimshatsui, HK, China. Tel.: (852) 3185-6500. Diimport dan Diedarkan Oleh: Mattel Continental Asia Sdn Bhd. Level 19, Tower 3, Avenue 7, No. 8 Jalan Kerinchi, Bangsar South, 59200 Kuala Lumpur, Malaysia. Mattel South Africa (PTY) LTD, Office 102 I3, 30 Melrose Boulevard, Johannesburg 2196. Dystrybutor: Mattel Poland Sp. z o.o., Warsaw Trade Tower 34 p., ul. Chłodna 51, 00-867 Warszawa. Mattel Australia Pty. Ltd., 658 Church St., Richmond, Victoria, 3121. Consumer Advisory Service - 1300 135 312. Mattel AEBE. Εβδούρου Μακαρίου 1, Κτήριο Κ-2, ΤΚ 17561, Παλαιό Φάληρο. Mattel Oyuncakçılık Tic. Ltd. Şti. İçerenköy Mah., Umut Sok. No:10-12 Quick Tower Kat:2/15 34752 Ataşehir İstanbul Tel: 0216 570 75 00. Импортёр/Уполномоченная организация: ООО "МАТТЕЛ" Российская Федерация, 105120 Москва, 2-й Сыромятинский переулок 1; +7 495 287 79 39. Mattel Czech Republic s.r.o., The Forum, Václavské nám. 19, 11000 Praha 1. Mattel, 333 Continental Boulevard, El Segundo, CA 90245, USA. Consumer Services: 1-800-465-MEGA (6342). Mattel Canada Inc., Mississauga, Ontario L5R 3W2. Consumer Services: You may call us free at/ Composez sans frais le 1-800-524-8697. Importado y distribuido por Mattel de México, S.A. de C.V., Miguel de Cervantes Saavedra No. 193, Pisos 10 y 11, Col. Granada, Alcaldía Miguel Hidalgo, C.P. 11520, México, Ciudad de México. R.F.C. MME-920701-NBB. Tels.: 59-05-51-00 Ext. 5206 6 01-800-463-59-89. Mattel Chile, S.A., Avenida Américo Vespucio 501-B, Quilicura, Santiago. Tel.: 1230-020-6213. Servicio al consumidor Venezuela: Tel.: 0-800-100-9123. Mattel Argentina, S.A., Av. Libertador 1000, Piso 11 - Oficinas 109 y 111, Vicente López - Prov. Buenos Aires. Tel.: 0800-666-3373. Mattel Colombia, S.A., Calle 12387-07 P5, Bogotá. Tel.: 01800-710-2069. Mattel Perú, S.A., Av. Juan de Arona n° 151, Centro Empresarial Juan de Arona, Torre C, Piso 7, Oficina 704, San Isidro, Lima 27, Perú. RUC: 20425853865. Reg. Importador: 02350-12-JUE-DIGESA. Tel.: 0800-54744. E-mail Latinoamérica: servicio.clientes@mattel.com. Mattel do Brasil Ltda.- CNPJ : 54.558.002/0001-20 - Rua Verbo Divino, 1488 - 2º - Andar - 04719-904 - Chácara Santo Antônio - São Paulo - SP - Brasil. Serviço de Atendimento ao Consumidor: fone 0800 575 0780. E-mail: sac.mattel@brazil@mattel.com



*HHP86



*HHP87



*HHP88



*HHW83†

