

MEGA

Barbie



HPN80

**DREAM CAMPER ADVENTURE™
AVENTURE EN CAMPING-CAR DE RÊVE**

CÁMPER DE LOS SUEÑOS / TRAILER DOS SONHOS
SUPER ABENTEUER-CAMPER / ФУРГОН ДЛЯ ПУТЕШЕСТВИЙ



Build Construisez

Construye
Constrói
Bauen | Стройте



Share | Partagez

Comparte | Partilha
Teilen | Делитесь

Devices not included | Appareils non inclus | Dispositivos no incluído
Dispositivos não incluídos | Geräte nicht enthalten | Устройства не входят в комплект



Play as you build! Jouez en construisant!

Juega mientras construyes!
Construção e brincadeira simultâneas!
Gleichzeitig bauen und spielen!
Строй и играй!



megaunboxed.com

CHOOSE WHAT YOU WANT TO BUILD FIRST! CHOISISSEZ CE QUE VOUS VOULEZ CONSTRUIRE EN PREMIER!

¡ELIGE QUÉ QUIERES CONSTRUIR PRIMERO! • ESCOLHA O QUE VOCÊ QUER CONSTRUIR PRIMEIRO! KINDER
KÖNNEN AUSSUCHEN, WAS SIE ZUERST BAUEN WOLLEN! • ВЫБЕРИ, ЧТО ТЫ ХОЧЕШЬ СОБРАТЬ СНАЧАЛА!



P.4



P.63



BUILD & CUSTOMIZE YOUR BARBIE® MICRO-DOLLS! ASSEMBLEZ ET PERSONNALISEZ VOS MINI-POUPÉES BARBIE!

¡CREA Y PERSONALIZA TU MICROMUÑECA BARBIE! • CONSTRÓI E PERSONALIZA AS TUAS MICROBONECAS BARBIE!
DIE BARBIE MIKROPUPPEN LASSEN SICH ZUSAMMENBAUEN UND NEU GESTALTEN!
СОБИРАЙТЕ И УКРАШАЙТЕ МИКРОКУКОЛ BARBI!

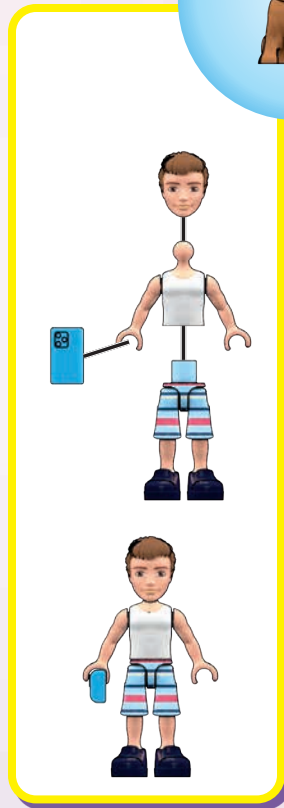
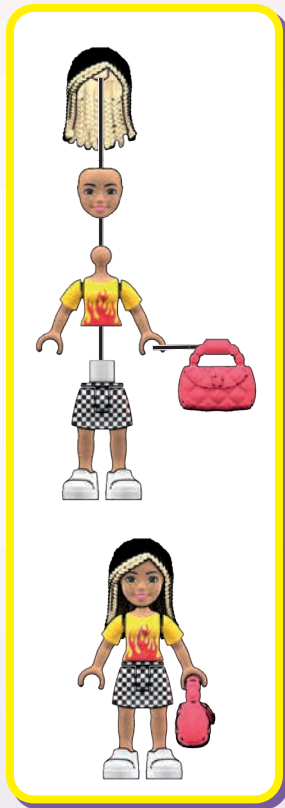
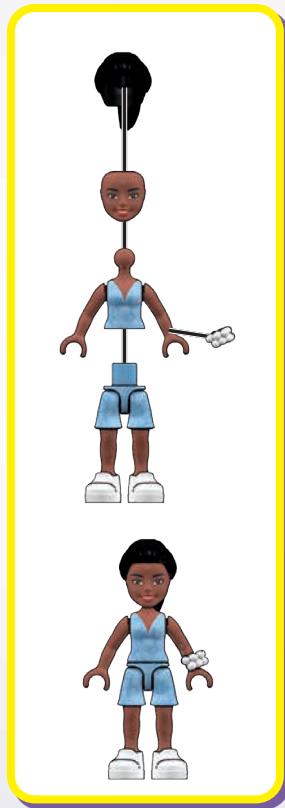
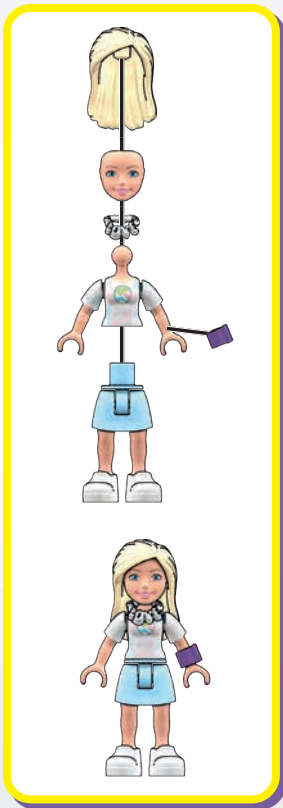

**LET'S BUILD THE
DREAM CAMPER™!**

**CONSTRUISONS LE
DREAM CAMPER!**

**¡CONSTRUYAMOS EL CÁMPER
DE BARBIE!**

**CONSTRUAMOS O TRAILER
DA BARBIE!**

DAS TRAUMWOHNMOBIL BAUEN!

**ДАВАЙ СОБЕРЕМ ВОЛШЕБНЫЙ
ДОМ НА КОЛЕСАХ!**

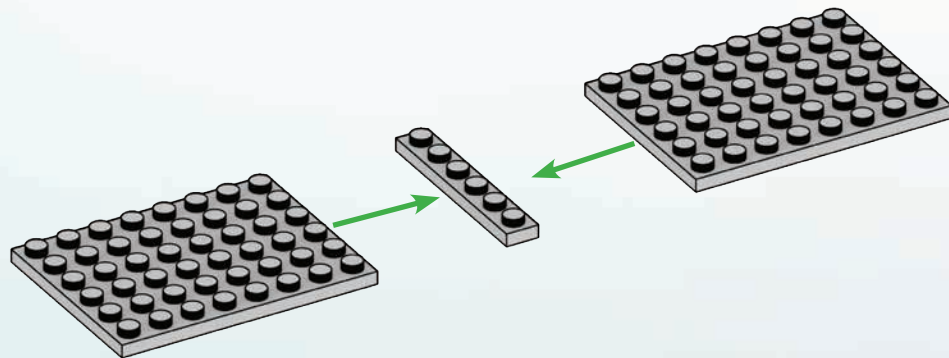
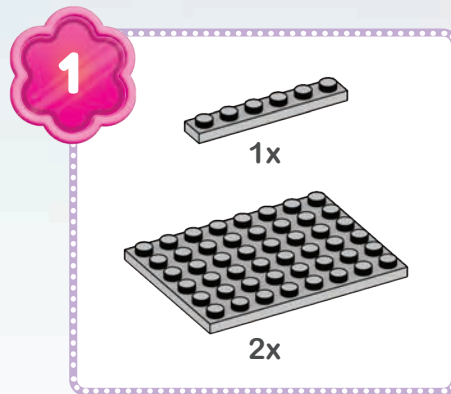
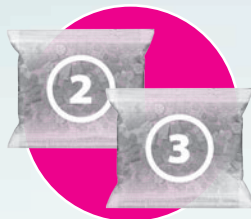

2



2x

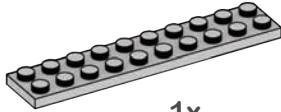

1x

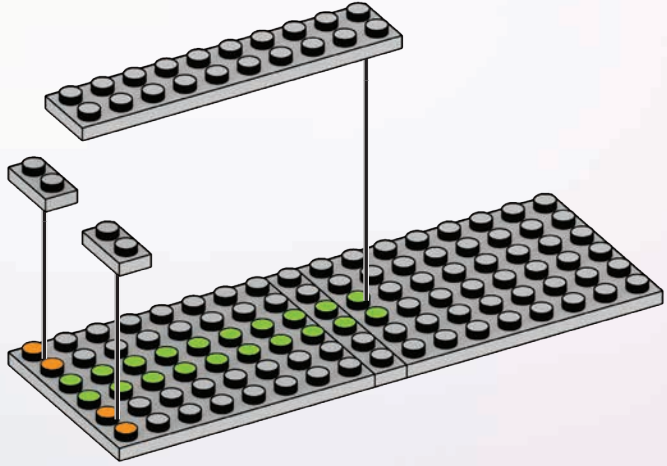

3



2x



2x

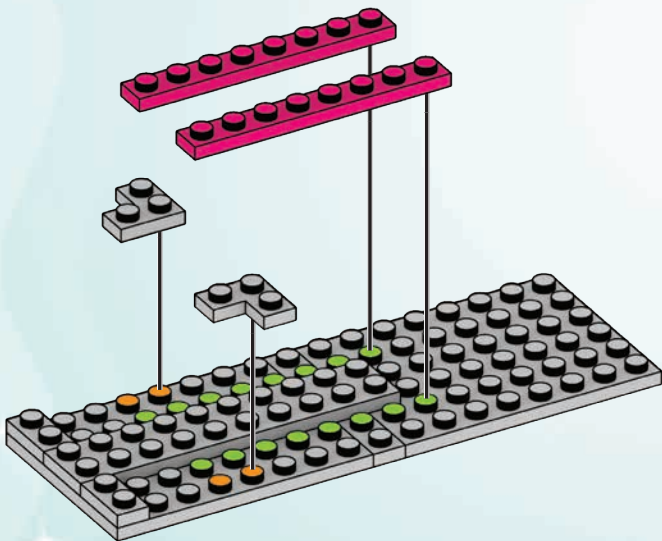

4



2x



4x

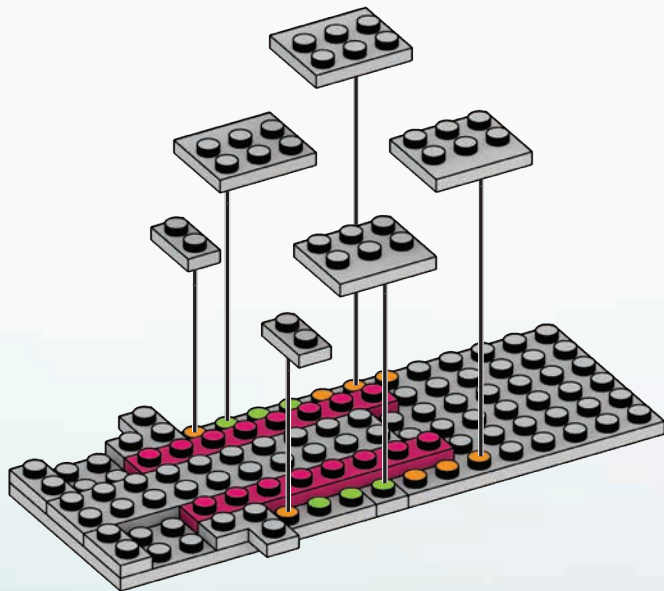

5



2x



1x



1x

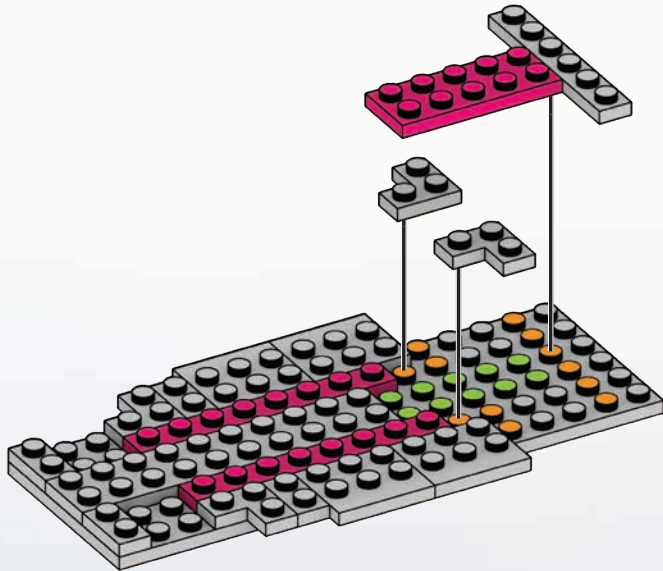

6



4x

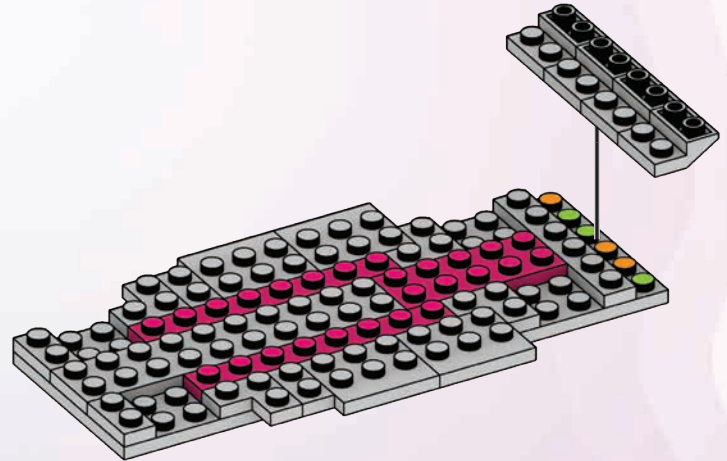

7



2x



2x



1x

8



2x



2x

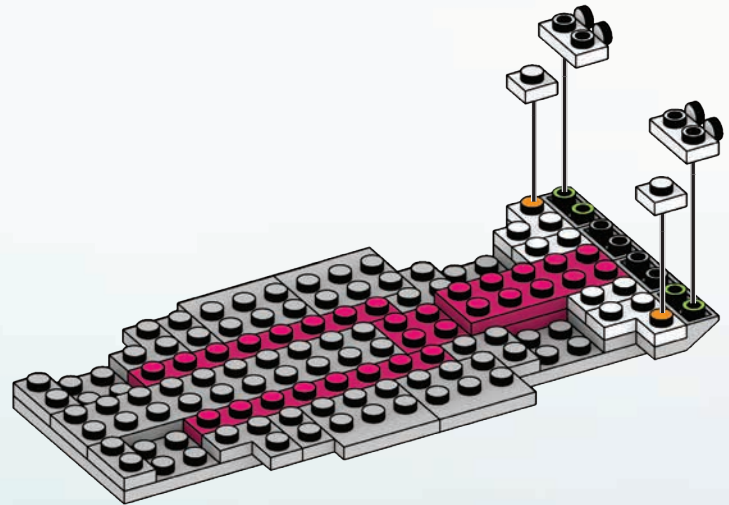
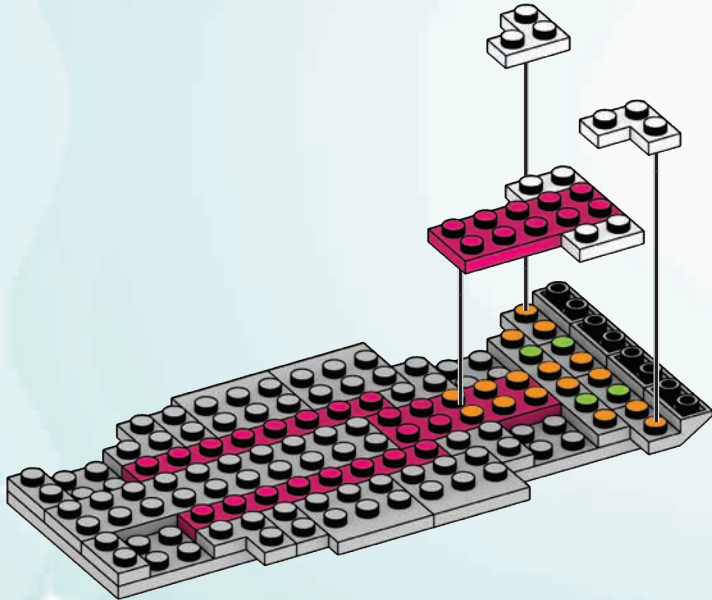

9

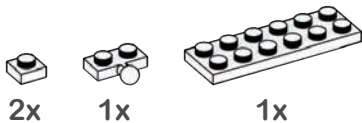

10

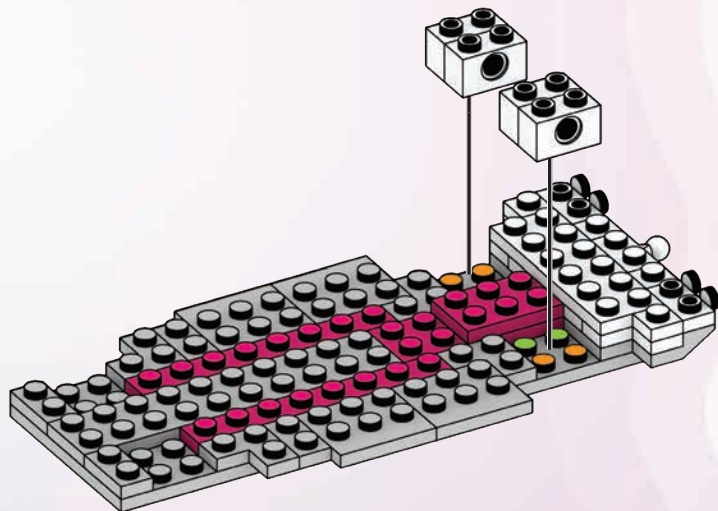
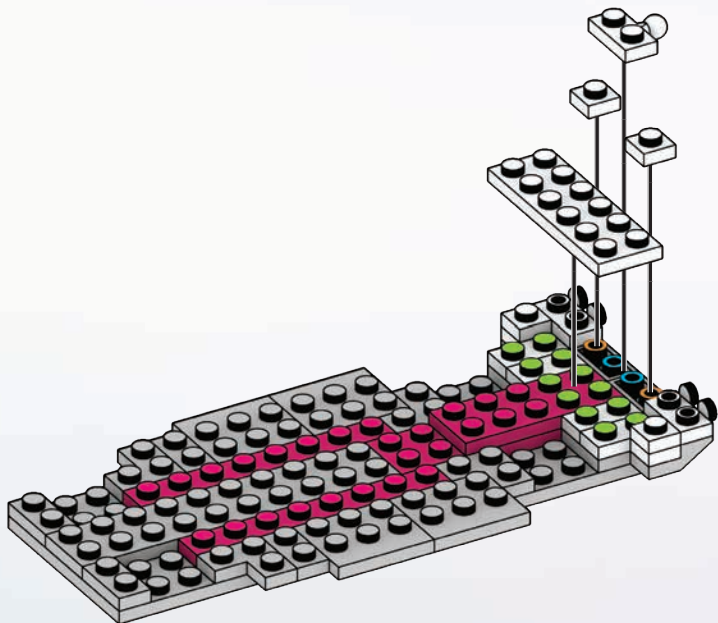

11



2x



1x

12



2x



2x

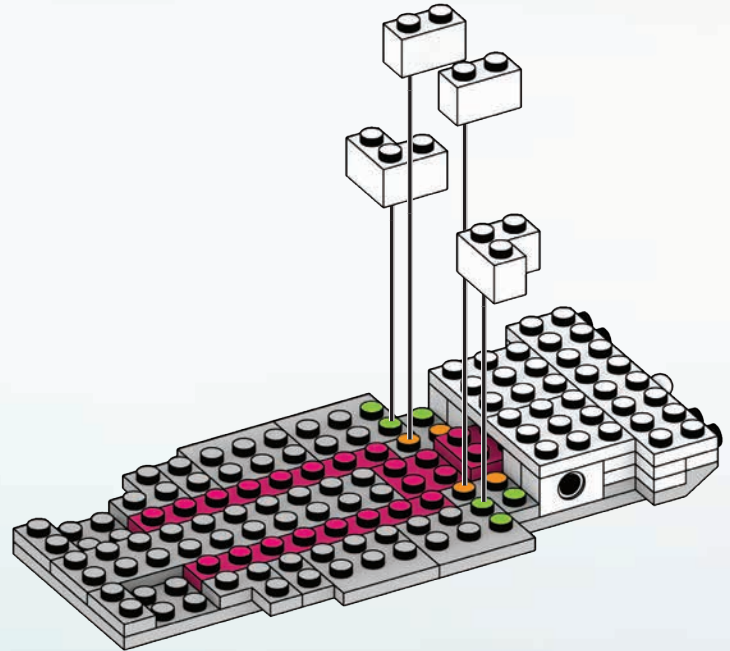
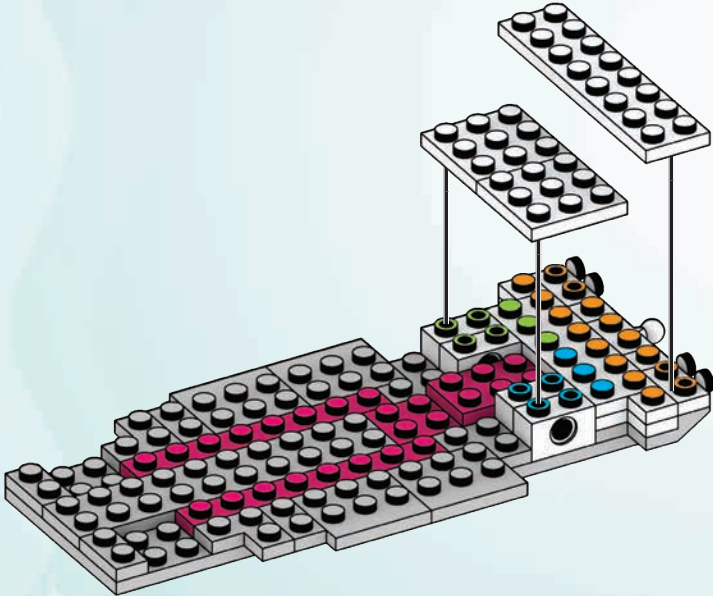

13



2x



1x

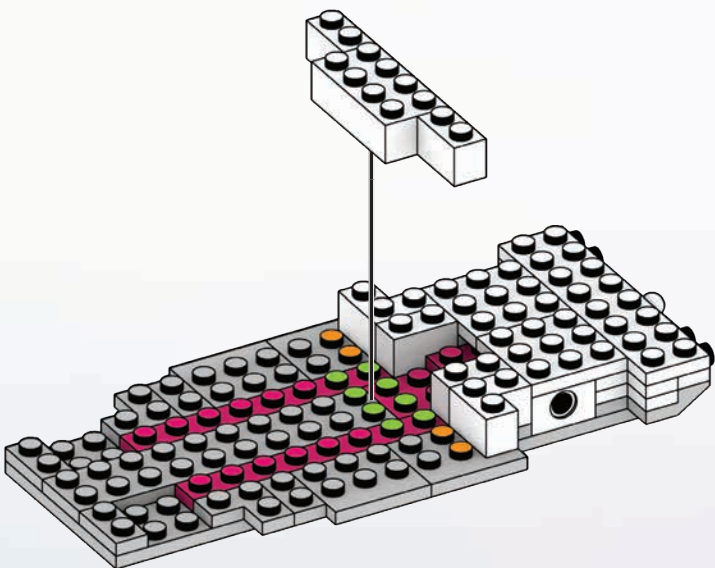

14



2x



2x

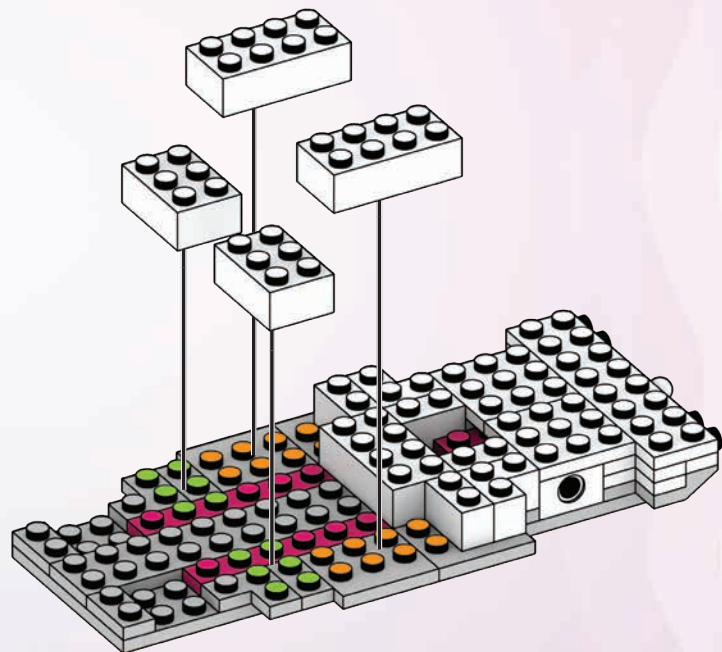

15



4x



1x

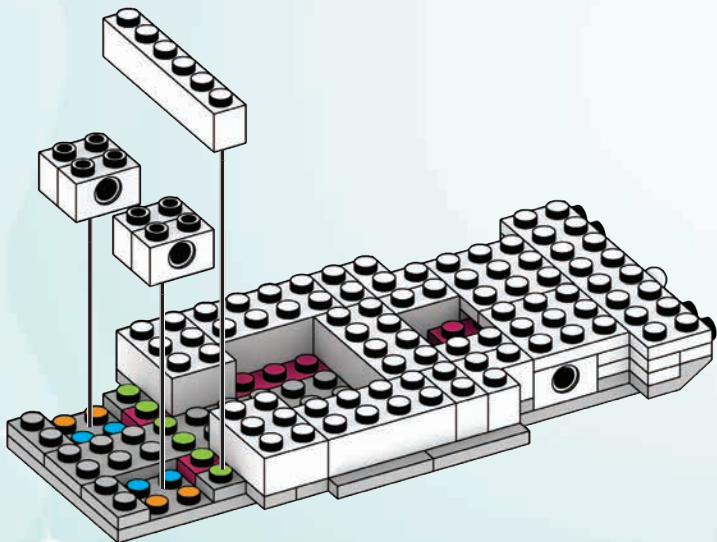

16



2x



1x

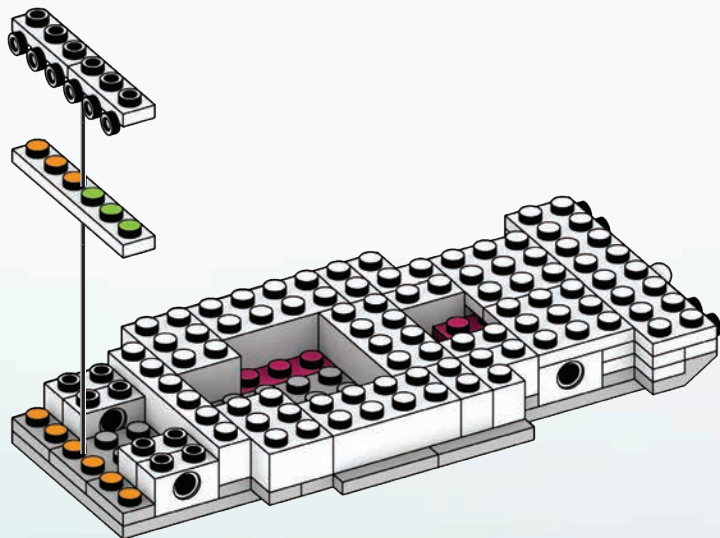

17



2x

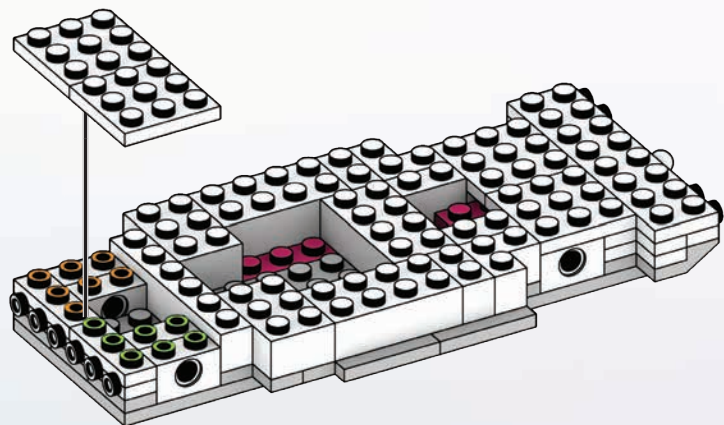

18



1x



1x



2x



1x

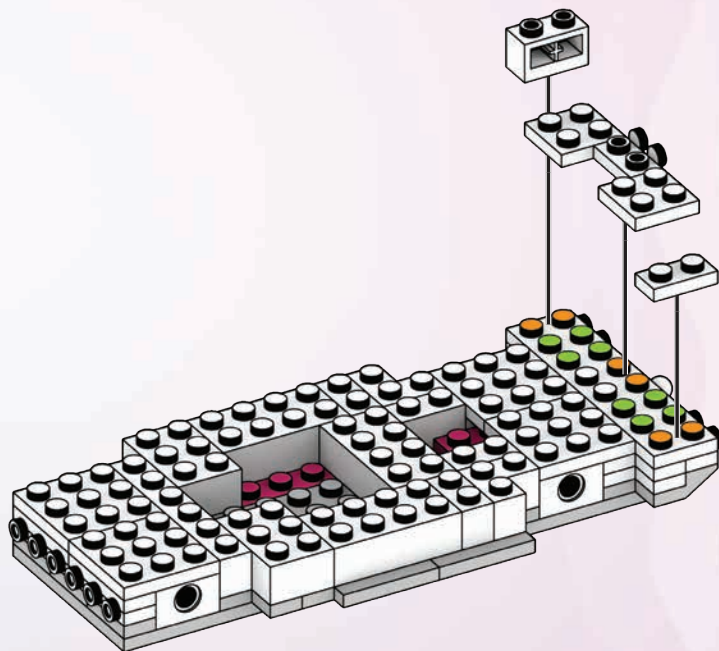

19



4x



1x

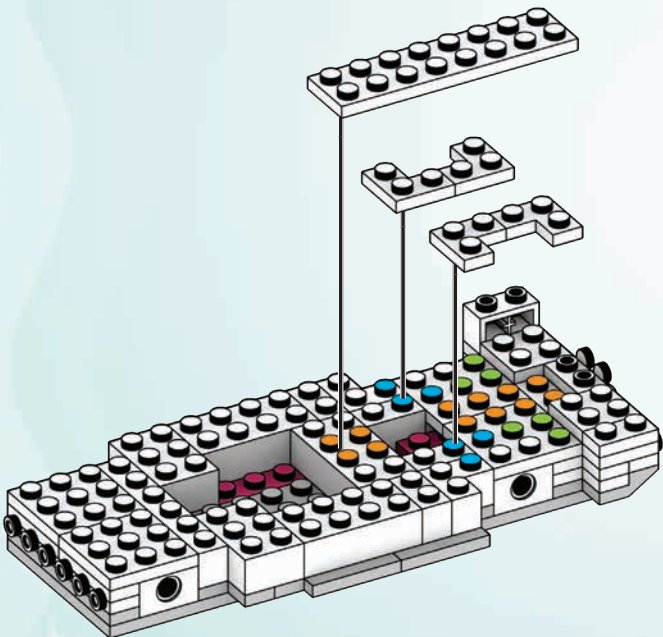

20



1x



2x

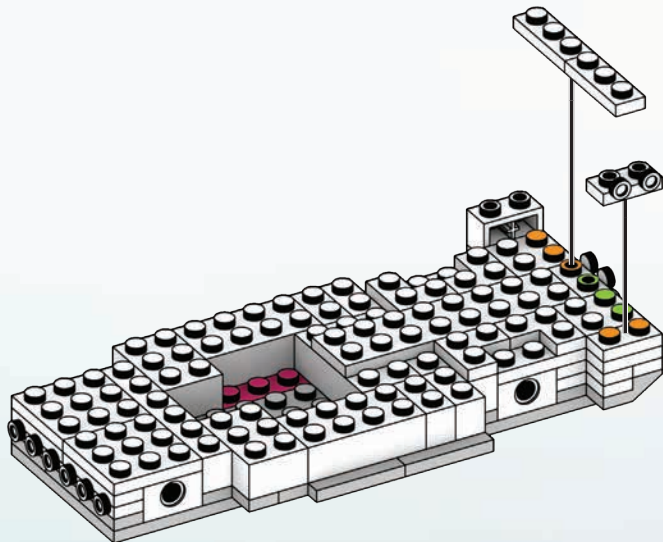

21



2x

2x

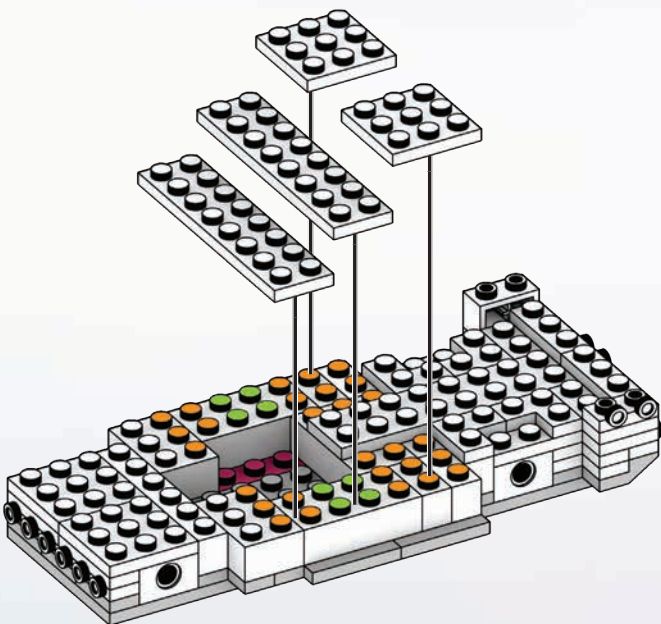

22



2x

1x

1x



1x

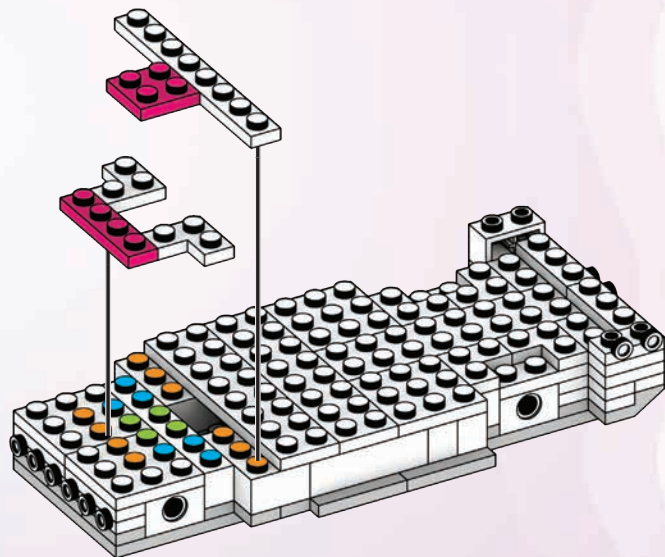

23



2x



2x

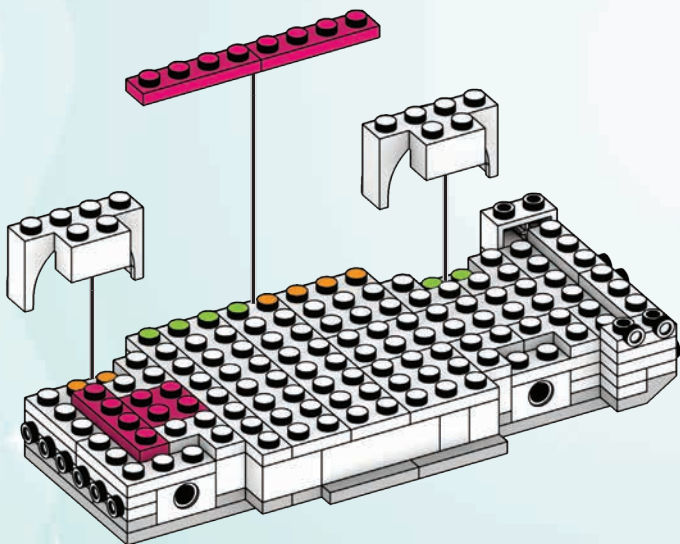

24



1x



2x



1x

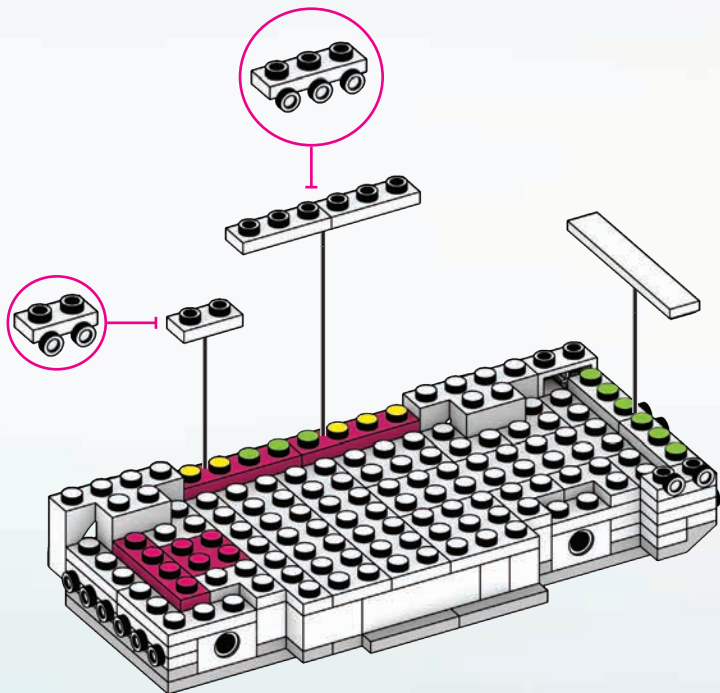

25

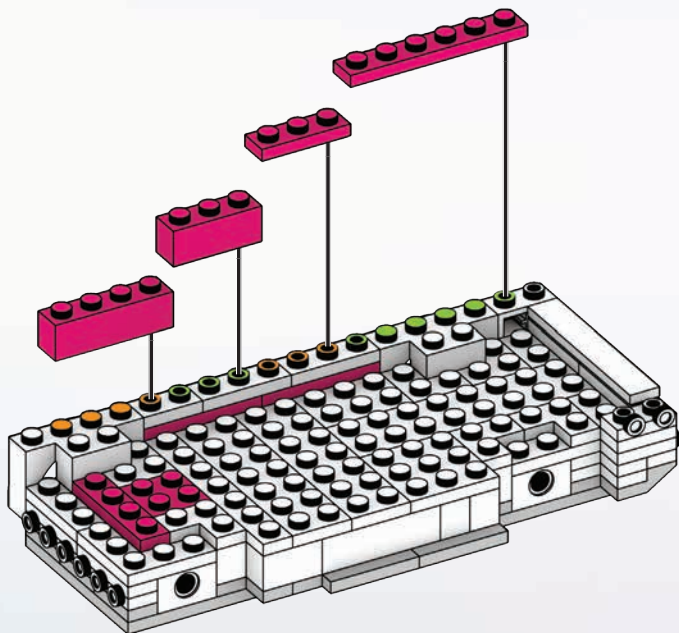
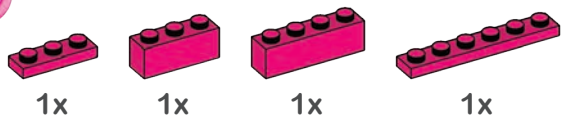

26

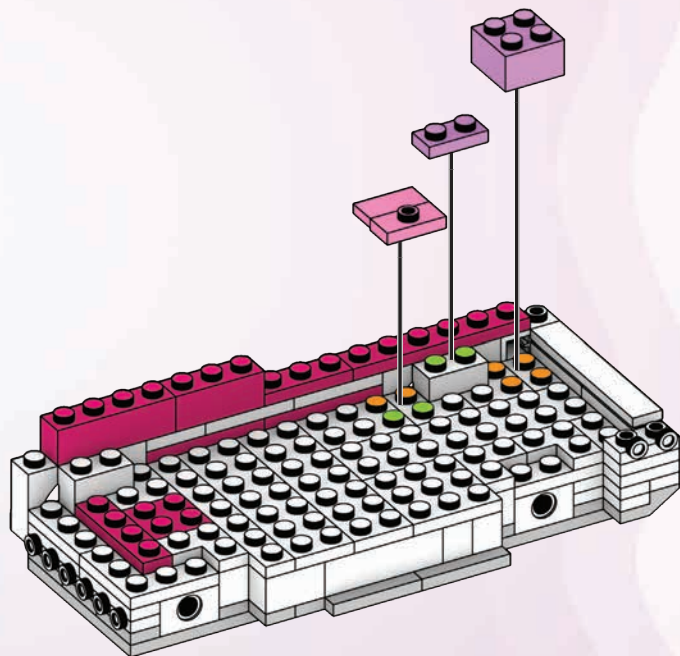
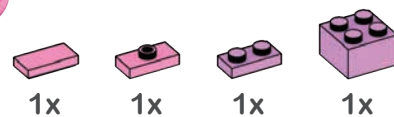

27



1x



1x



1x



2x

28



1x



1x



1x

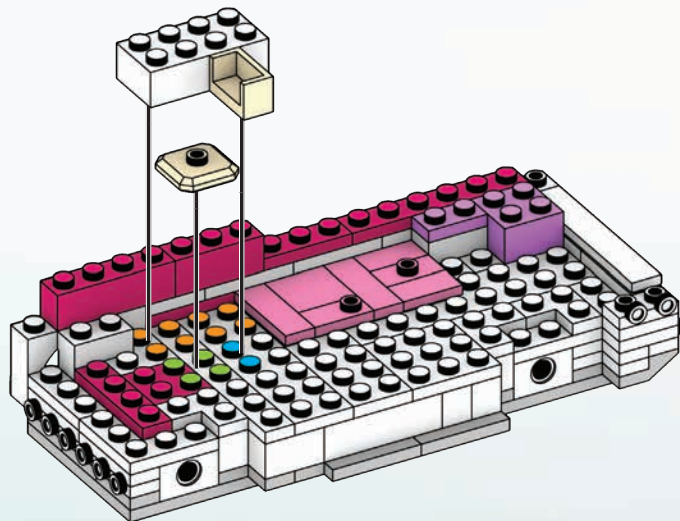
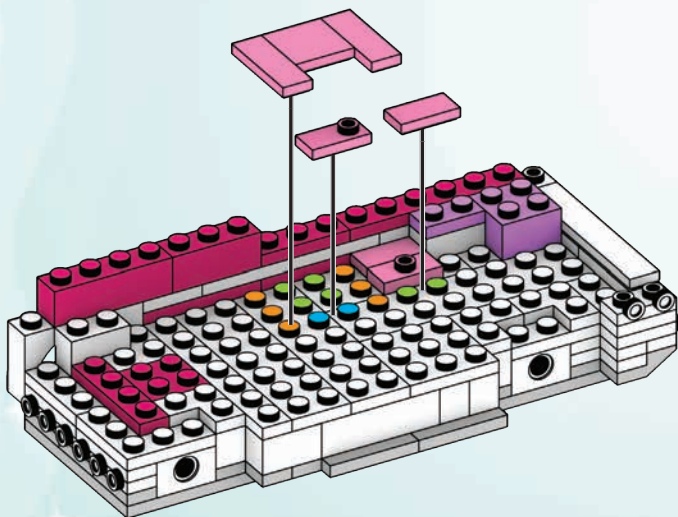

29



2x

1x

30

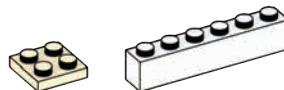

1x

1x

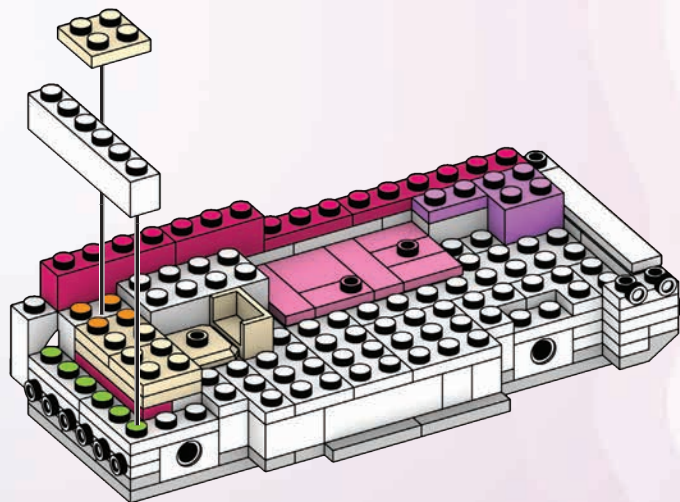
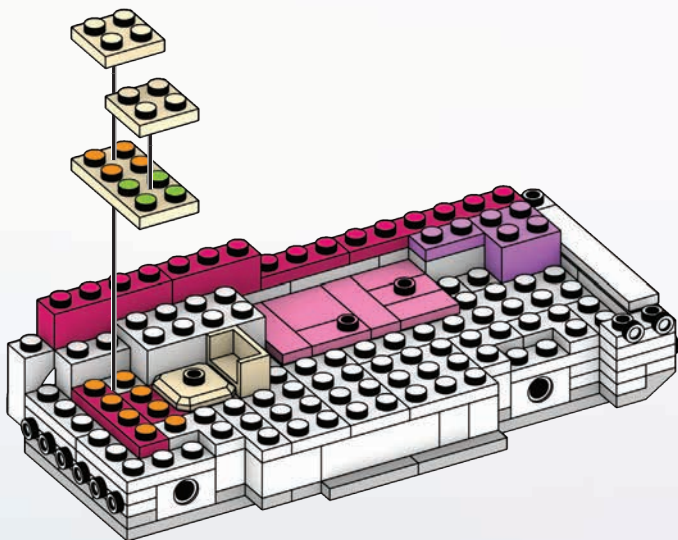

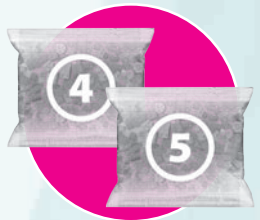

31

1x 2x 1x 1x

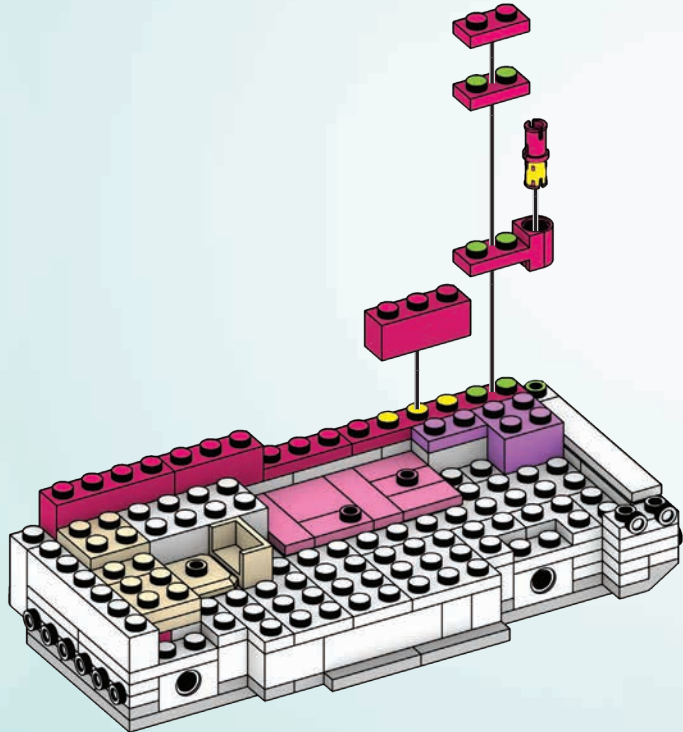

32

1x 1x 1x 1x

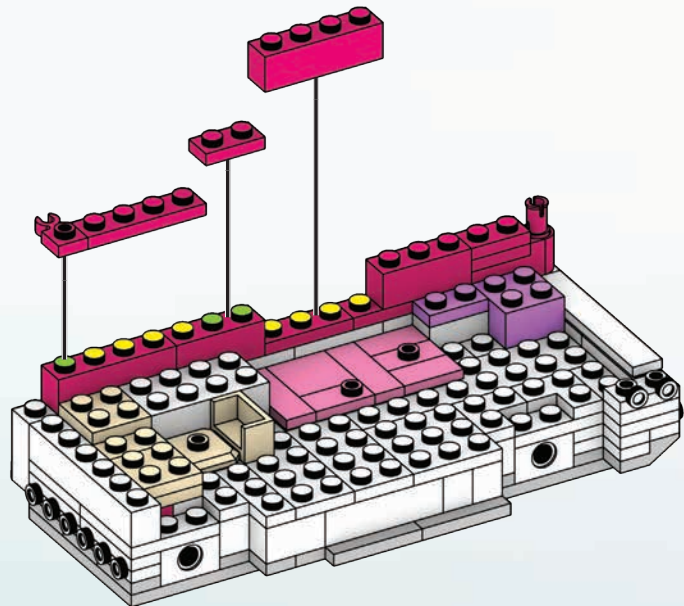

33



1x

1x

1x

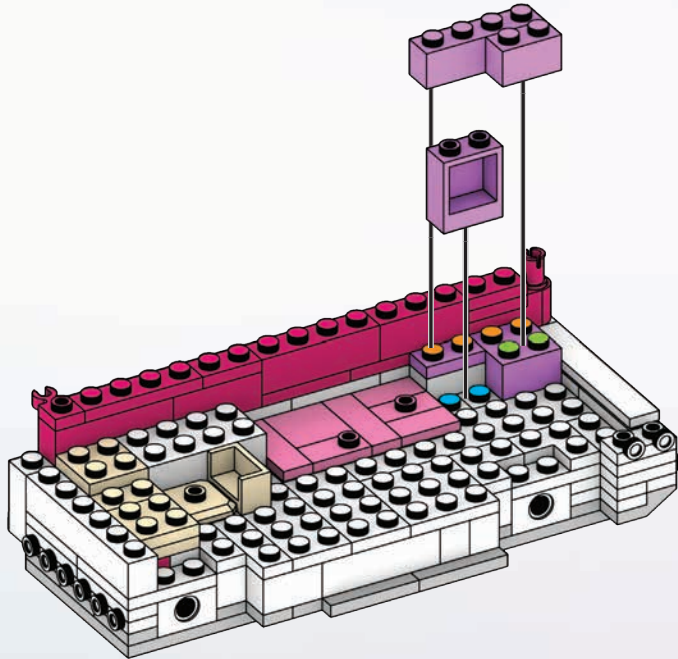

34

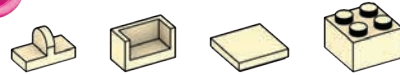

1x

1x

1x

1x

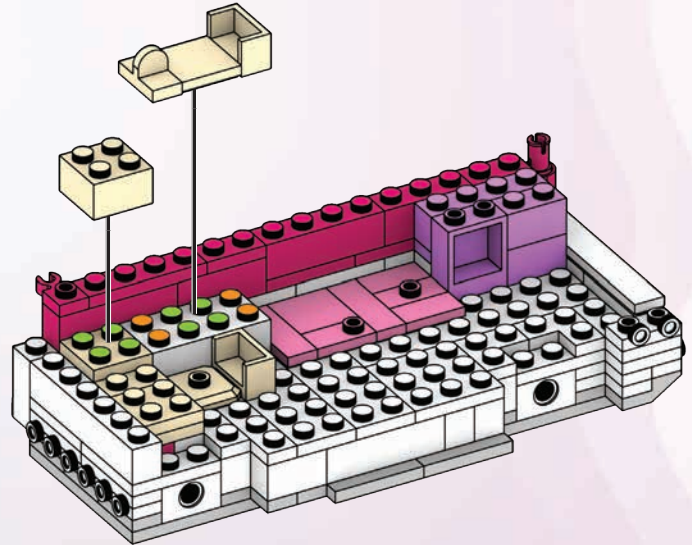

35

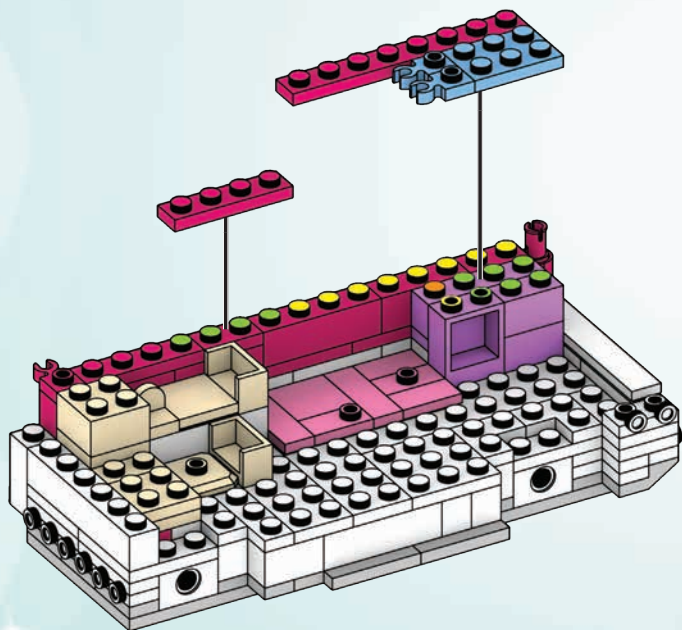
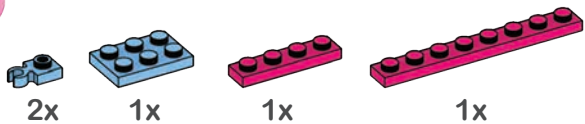

36

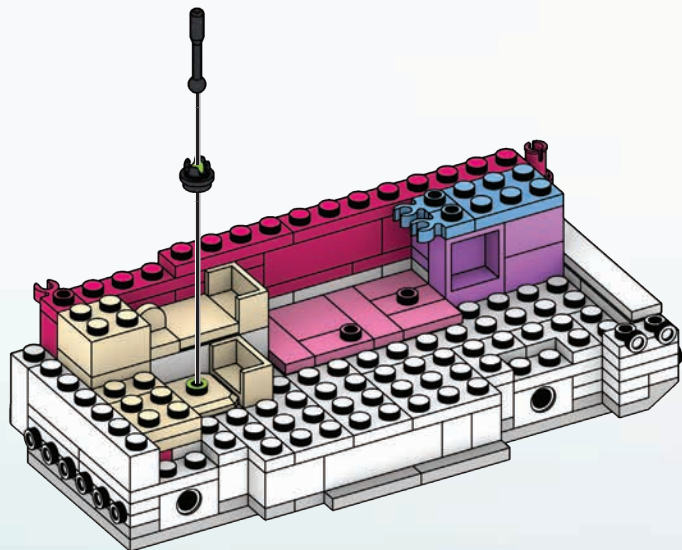

37

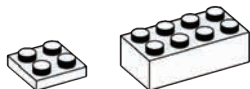

2x

2x

38



1x

1x

1x

1x

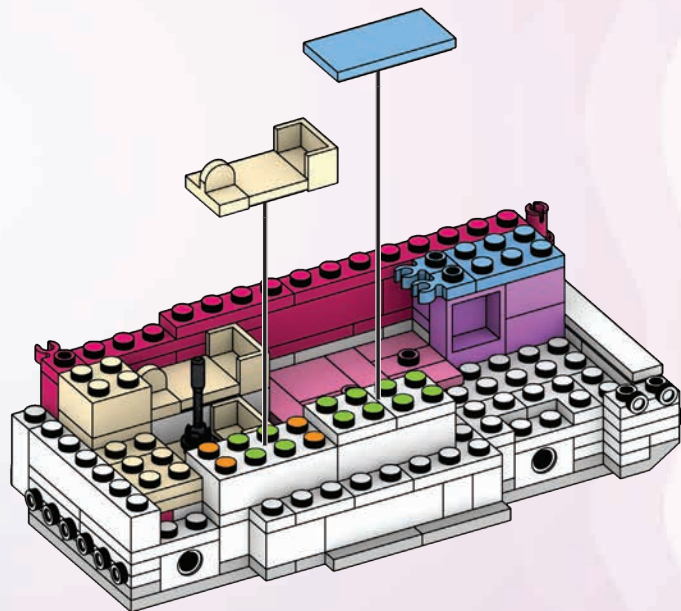
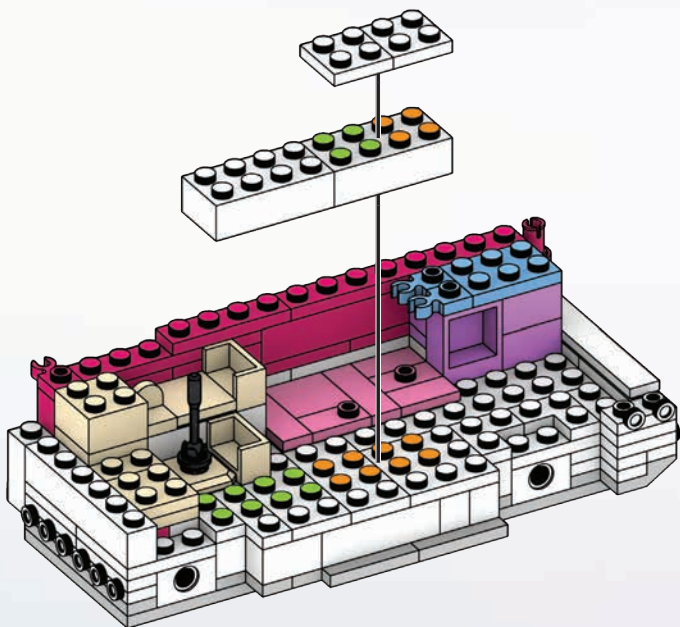

39



2x



2x

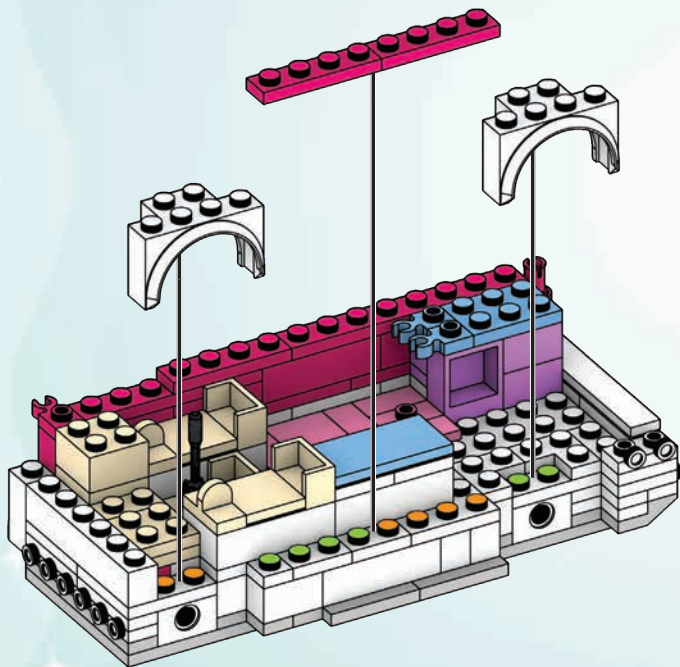

40



1x



1x



2x

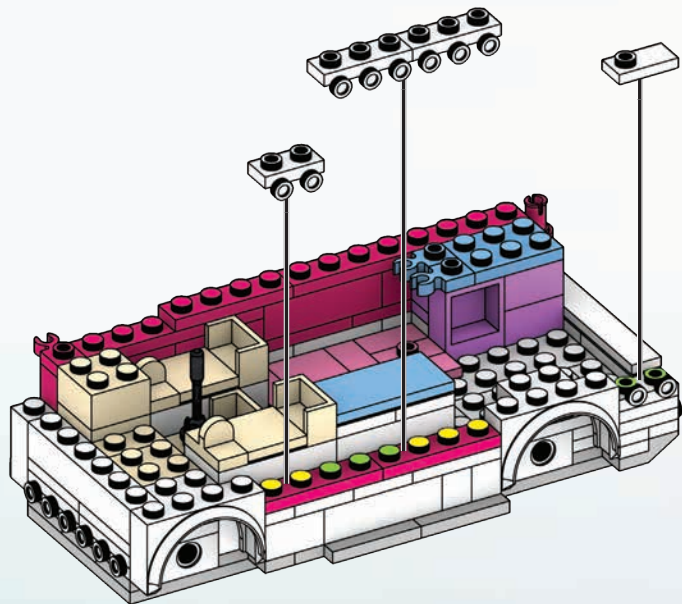

41



2x



1x

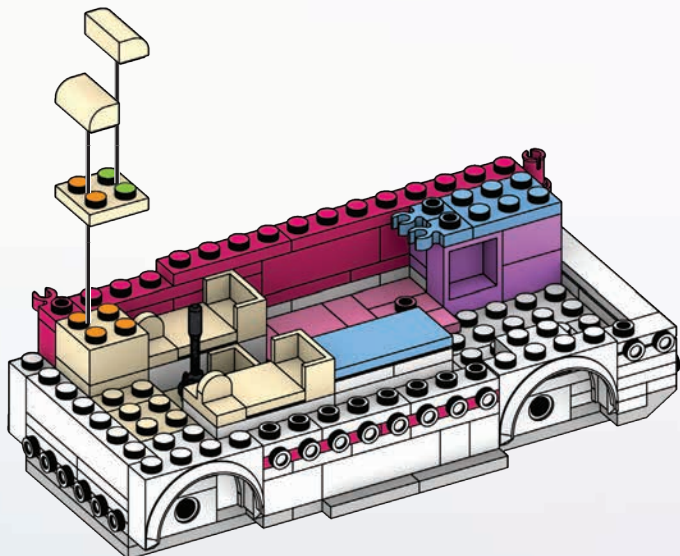

42



1x



1x



1x



1x

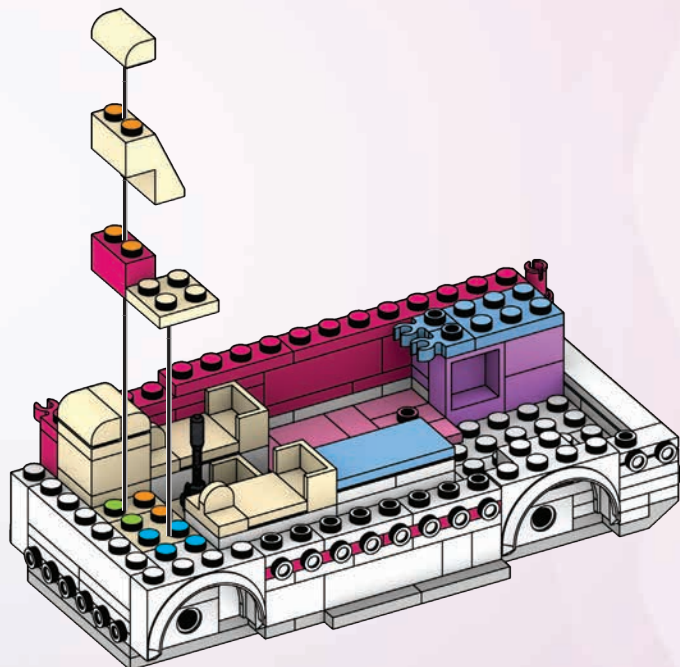

43

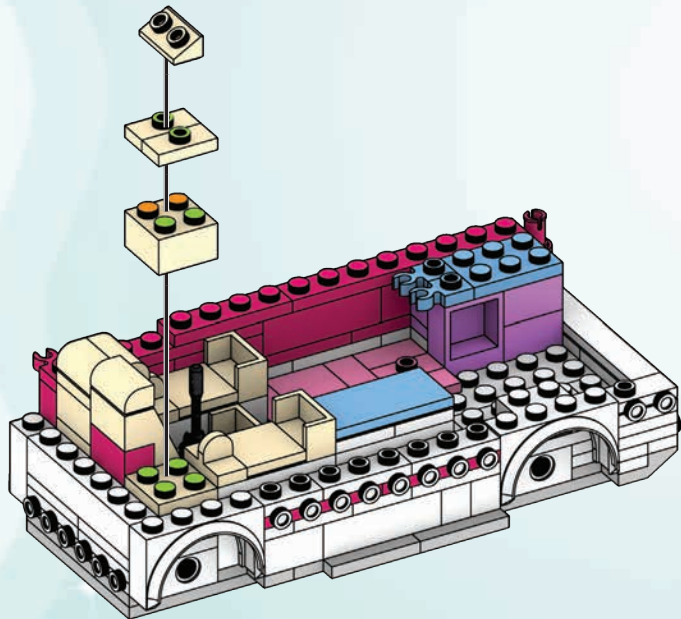

44

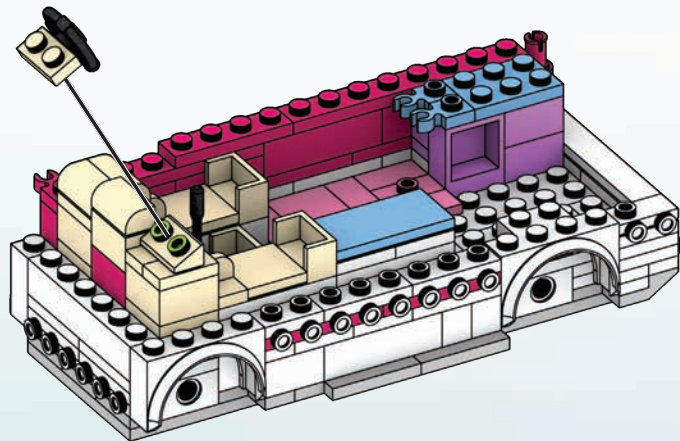
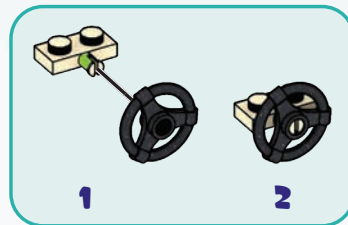

45

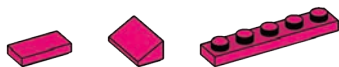

1x

1x

1x



1x

46



1x



1x



1x

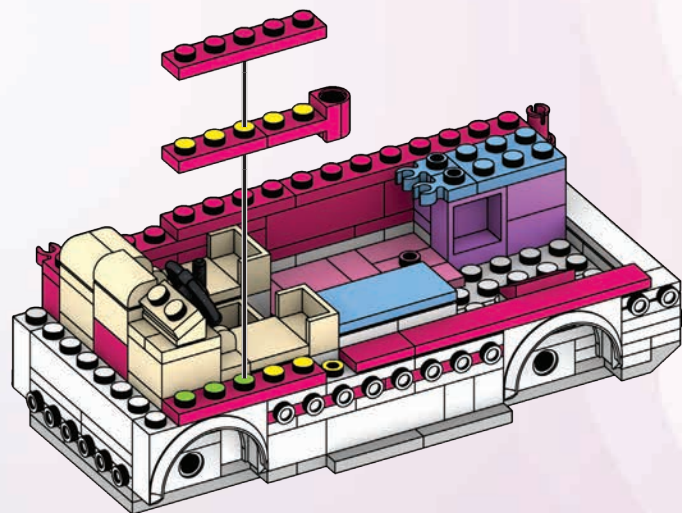
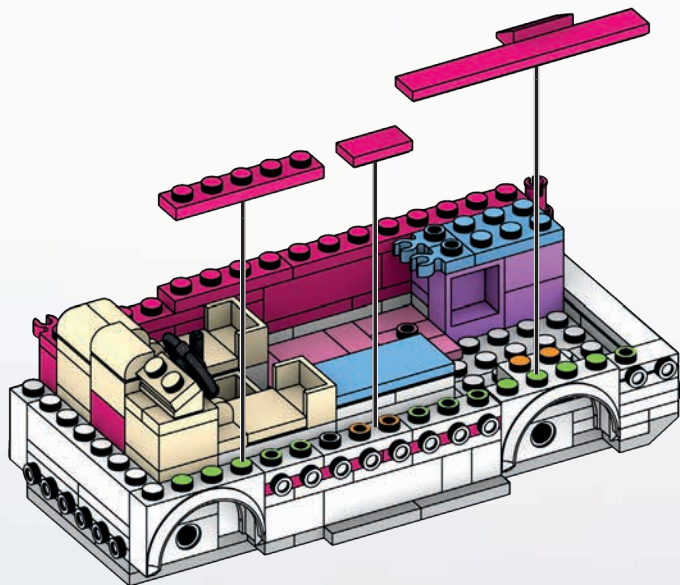

47



1x

1x

1x

48



1x

1x

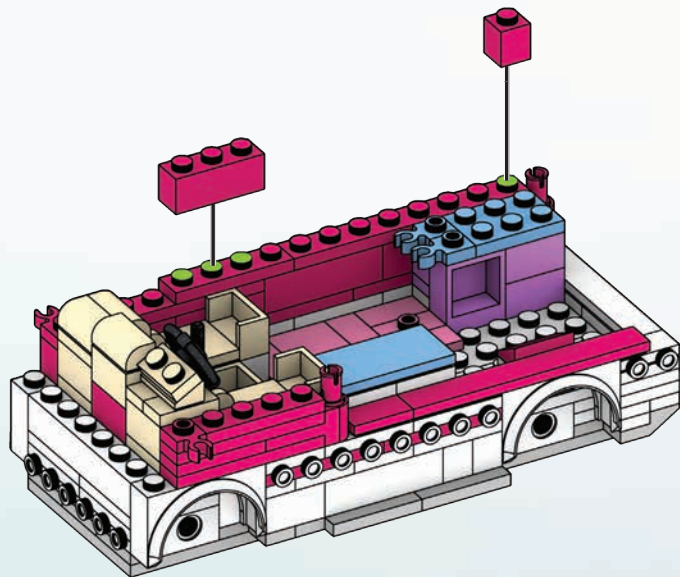
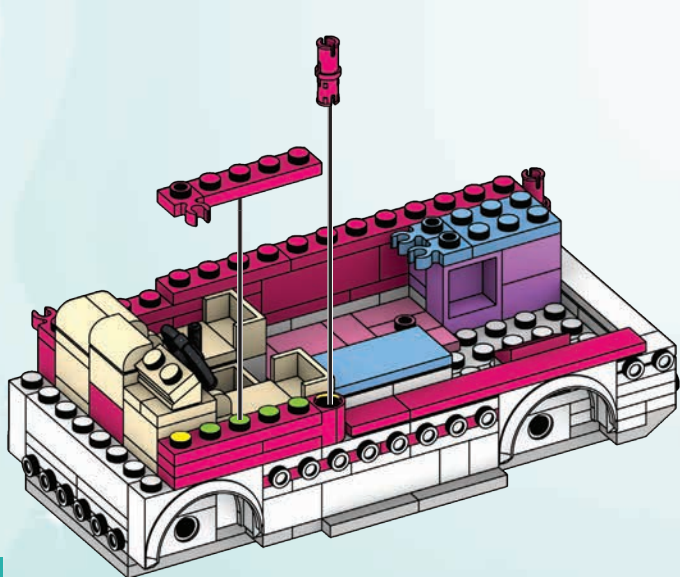

49



2x



2x

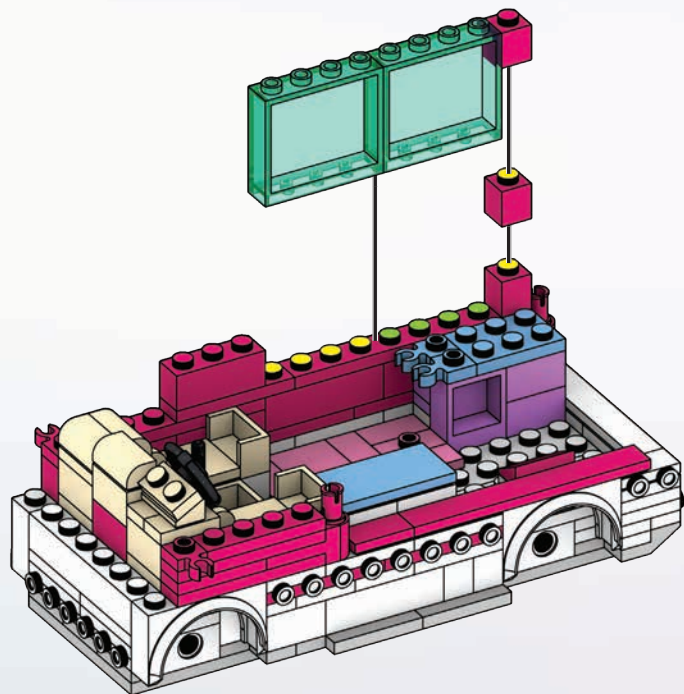

50



1x



1x



1x



1x



1x

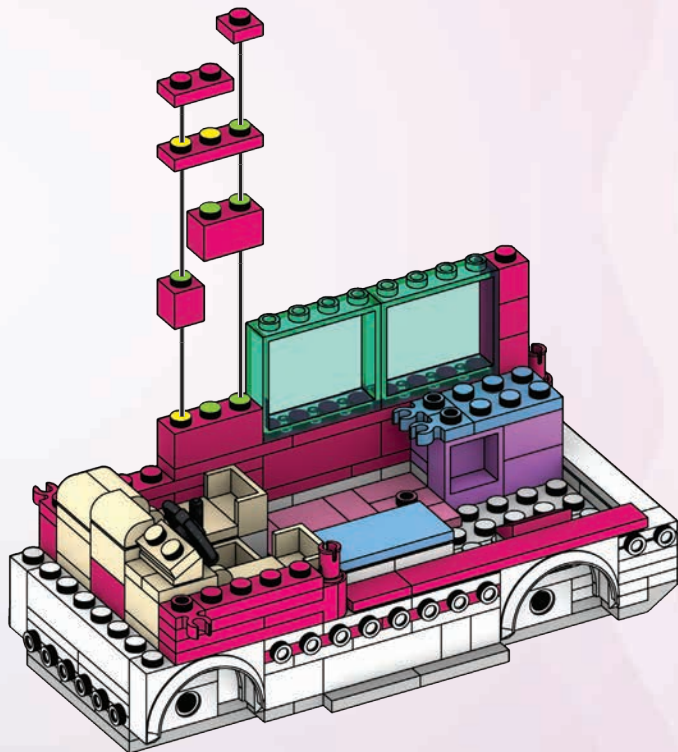

51

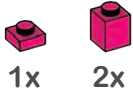

52

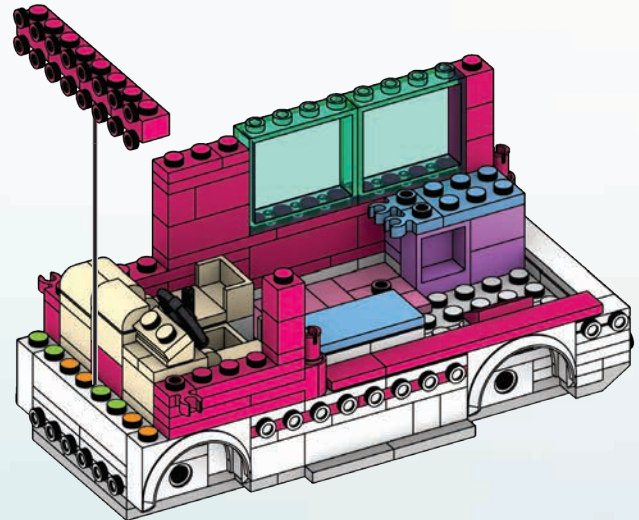
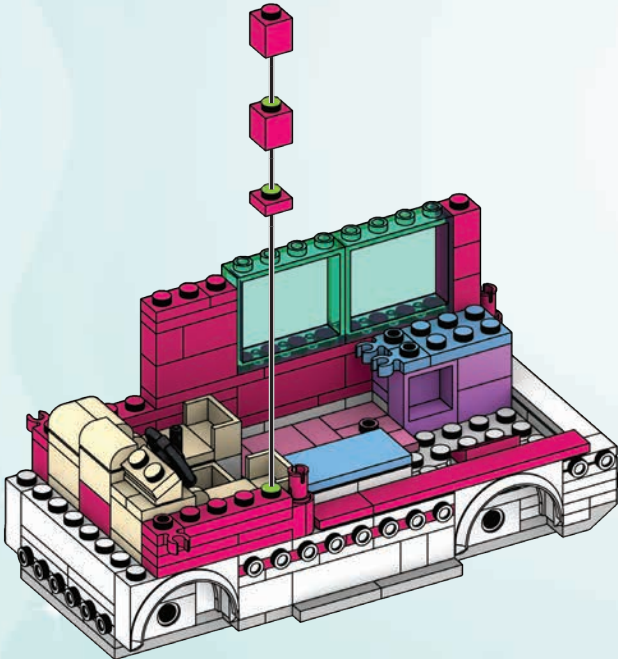

53



2x

1x

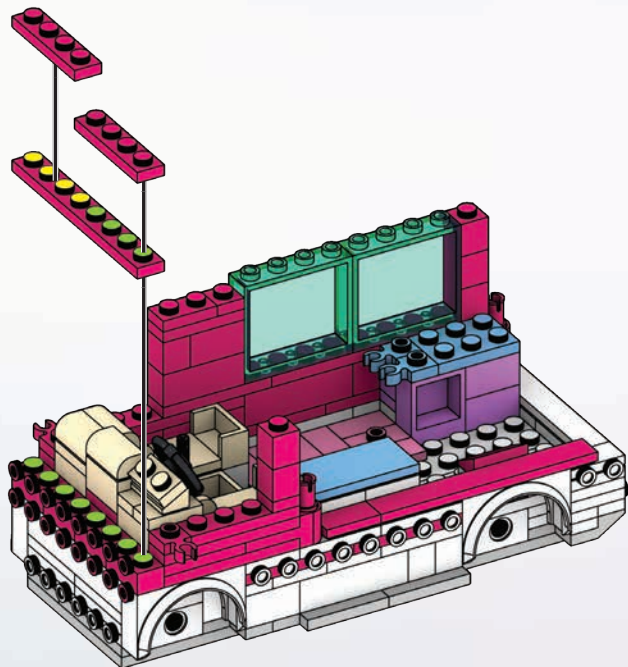

54

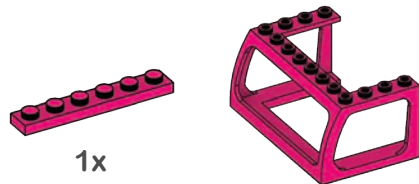

1x

1x

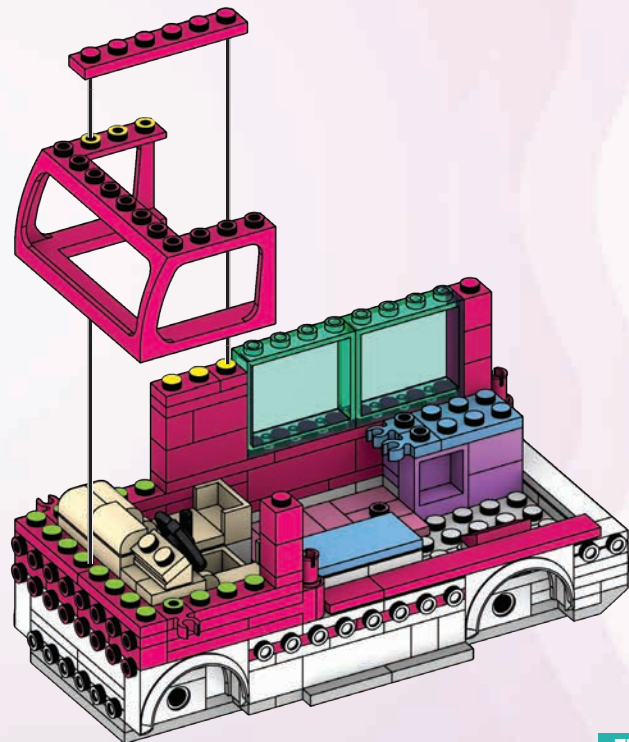

55



1x

56



1x



1x



1x



1x

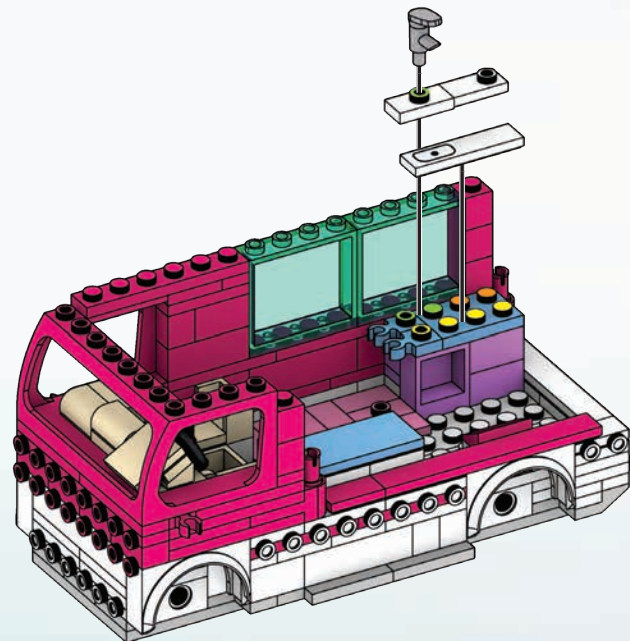
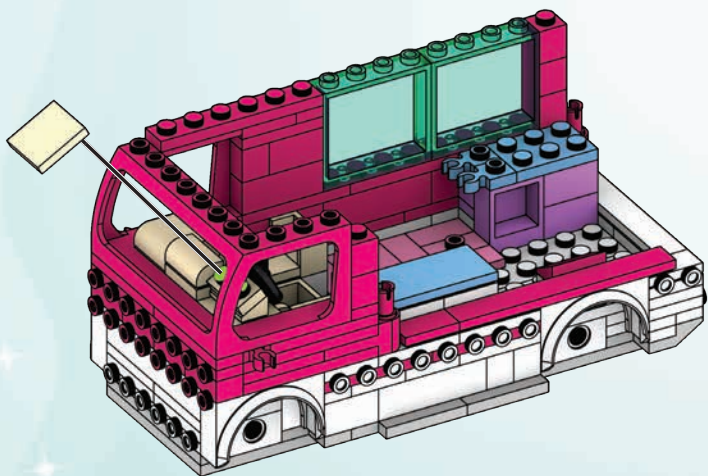

57



1x



1x



1x



1x

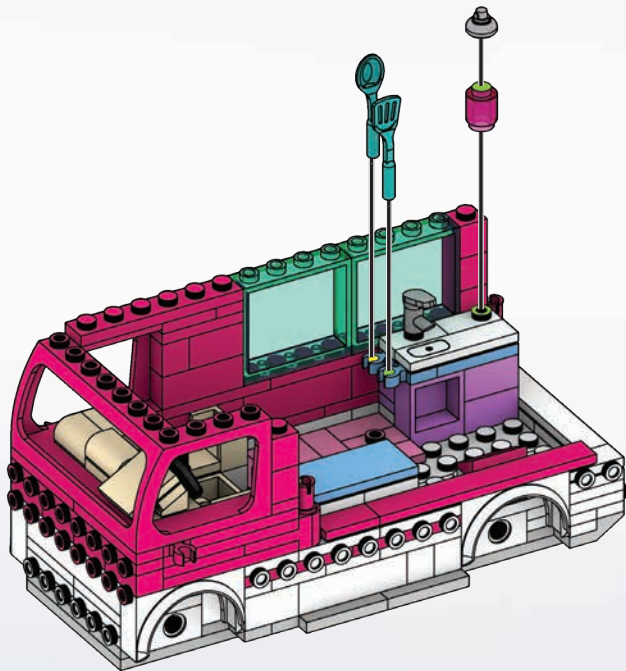

1

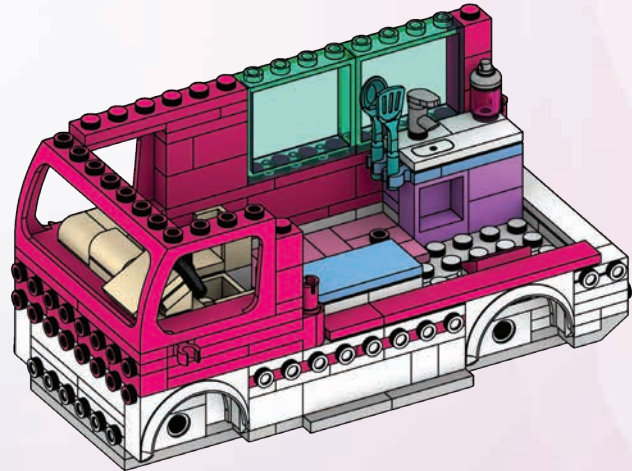

2

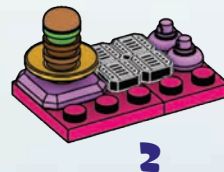
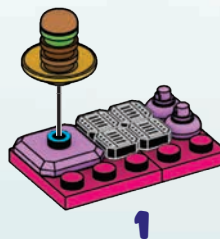
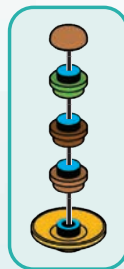
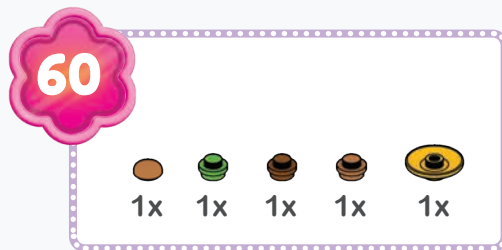
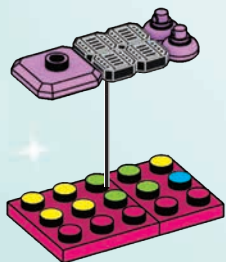
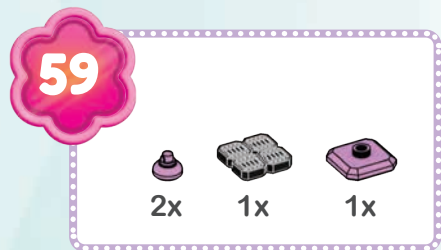
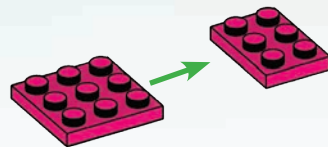
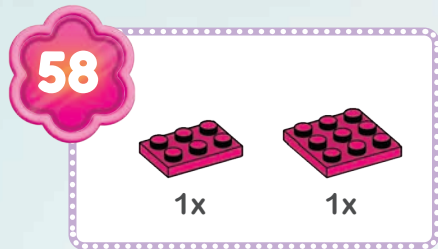

61

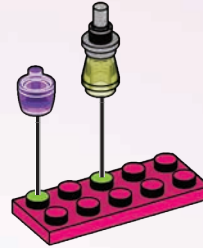
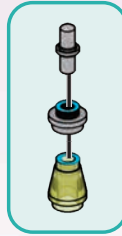

62

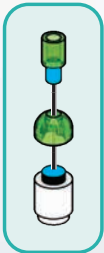

63

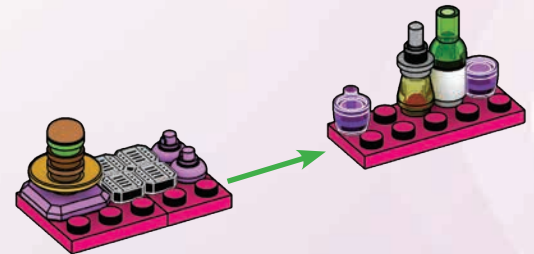

64

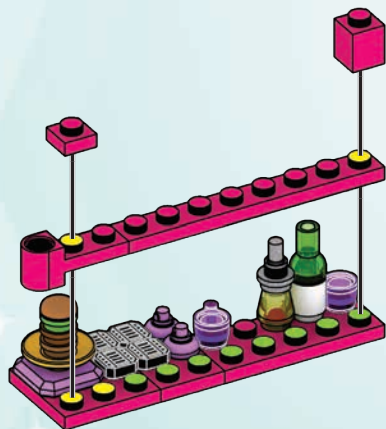
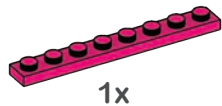
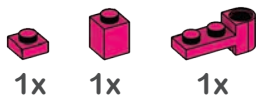

65

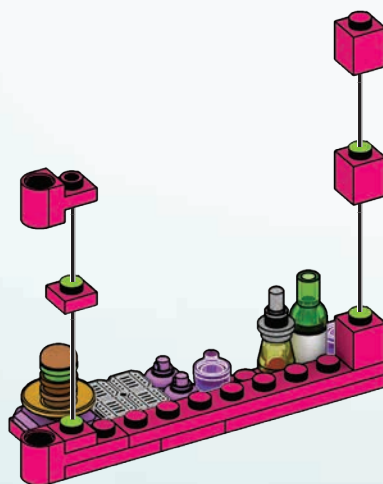

66

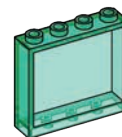

2x

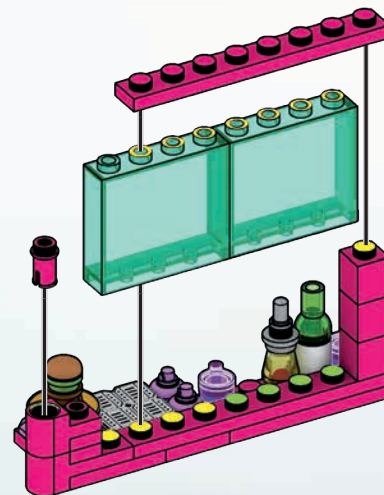
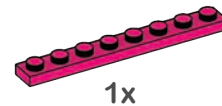

67



68



69

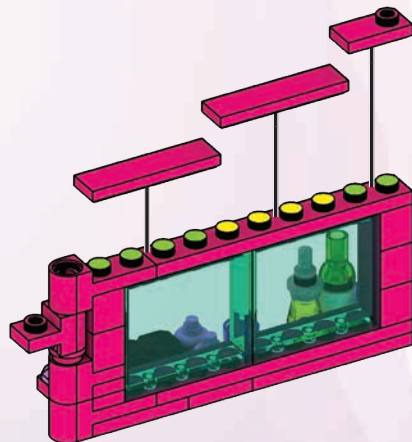
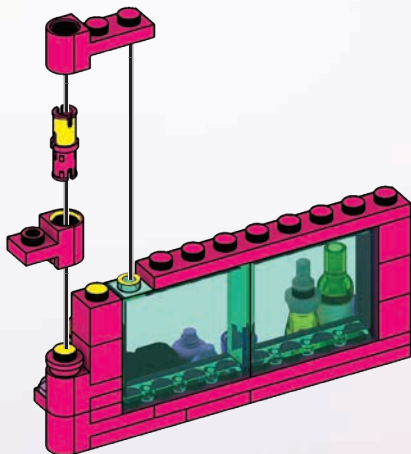
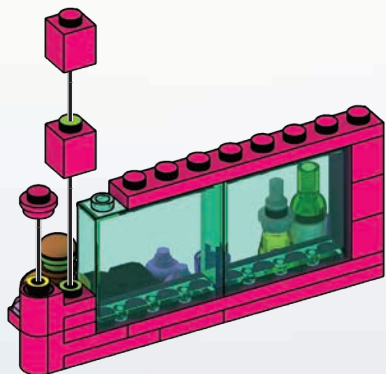
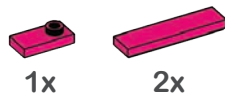

70



1x



2x



1x

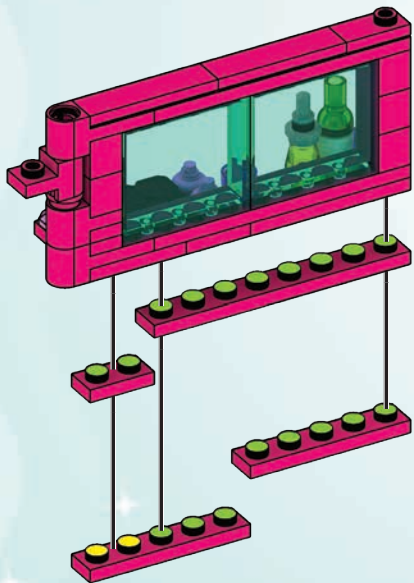

71

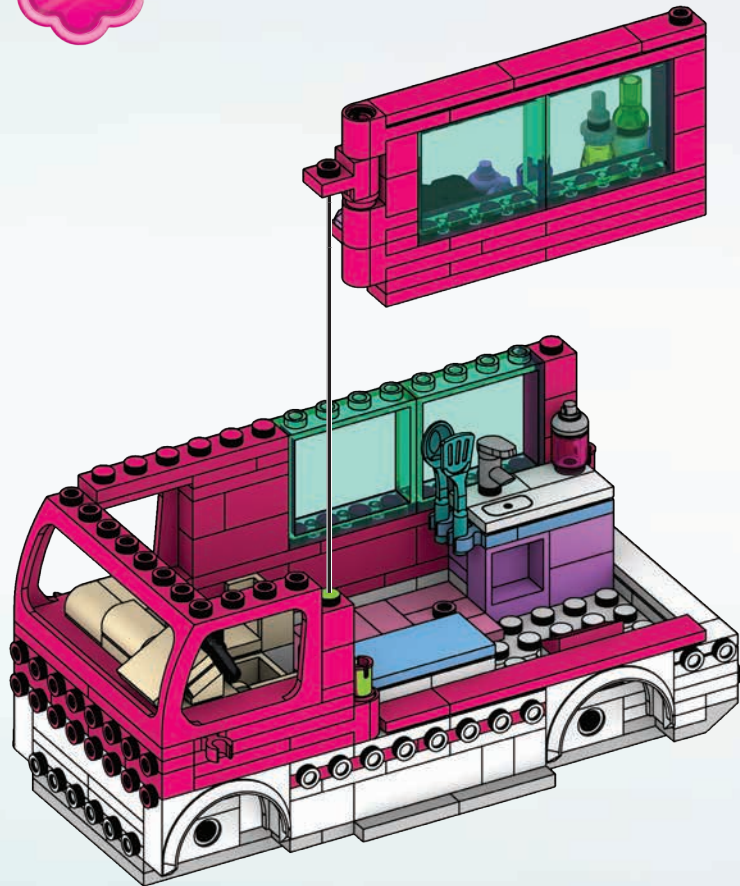

72

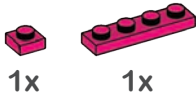

73

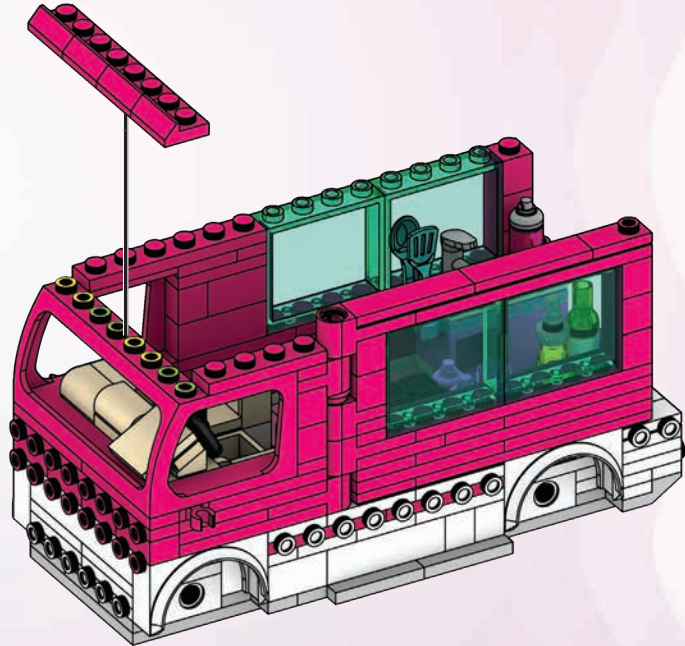
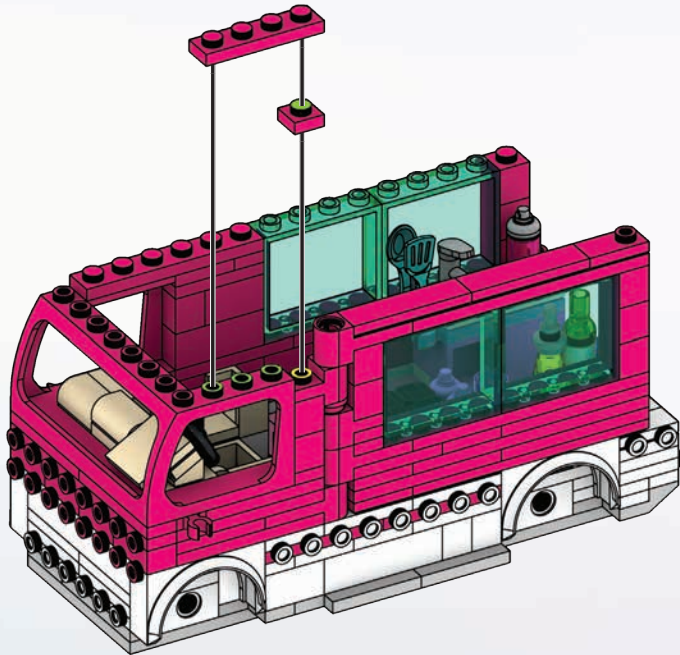

74



2x



1x



1x

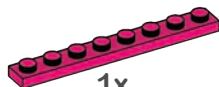

1x

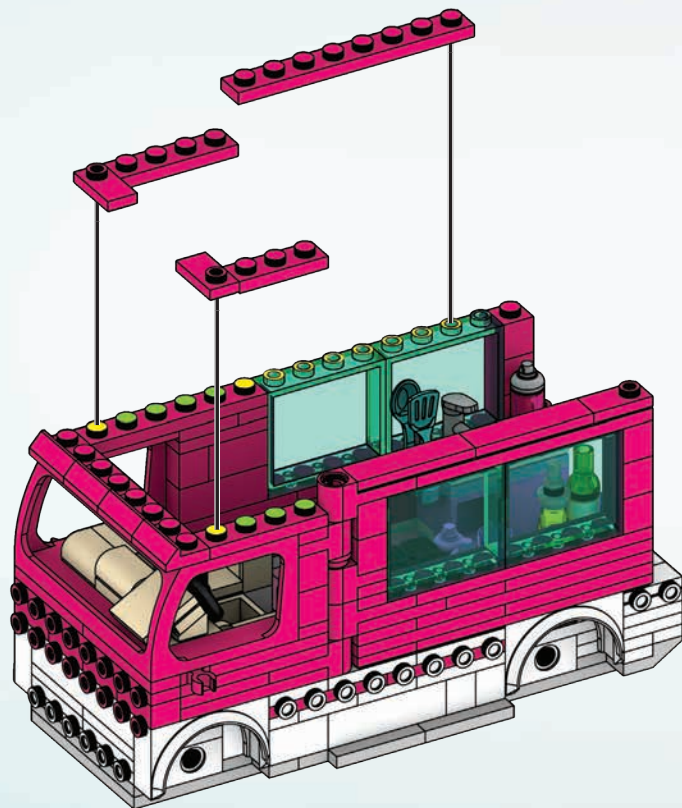

75



2x



3x

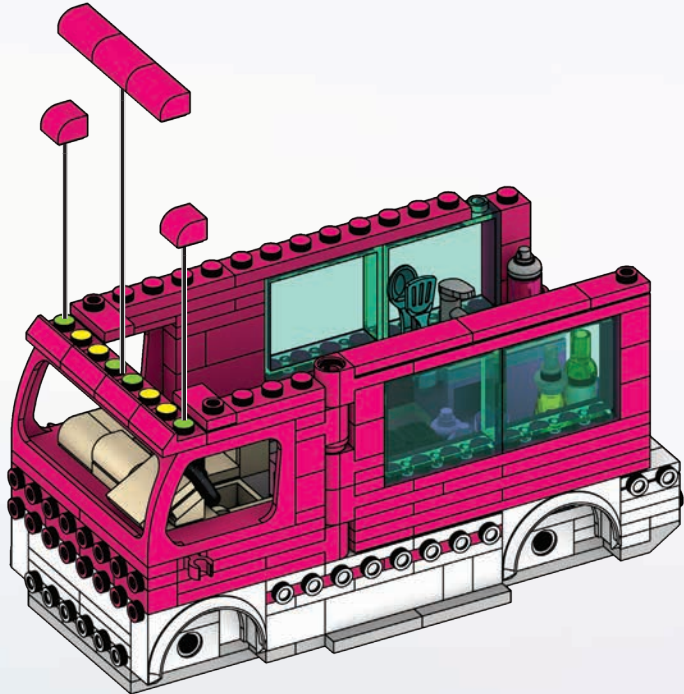

1

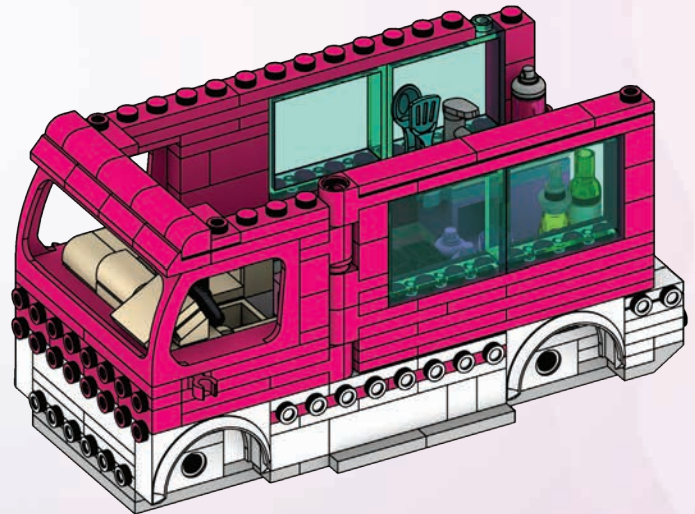

2

76



1x

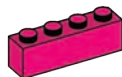

1x



1x



1x

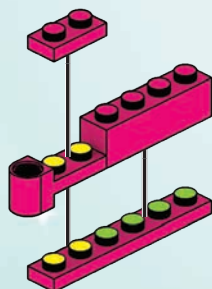

77



2x



2x

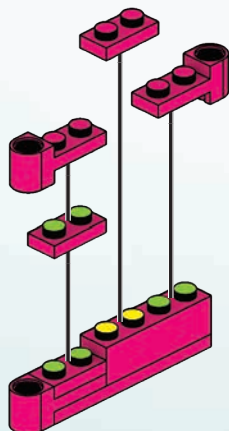

78



4x



1x

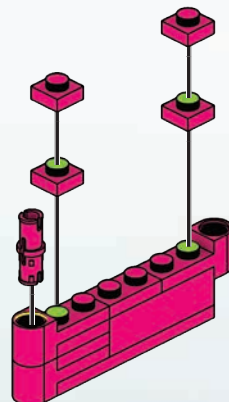

79

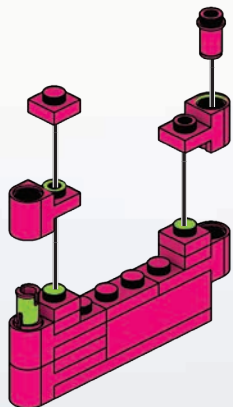

80

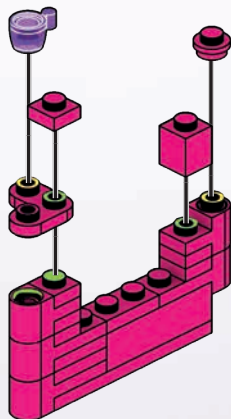

81

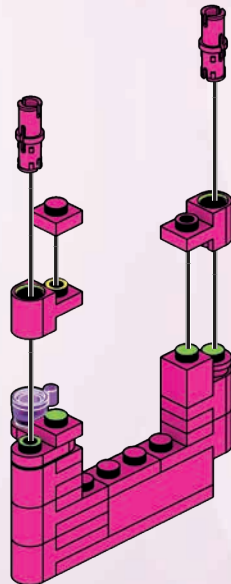

82



1x



1x



1x

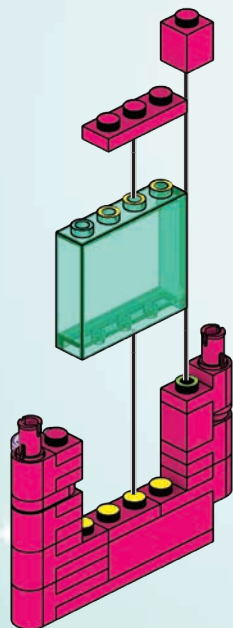

83



1x



1x



1x



1x

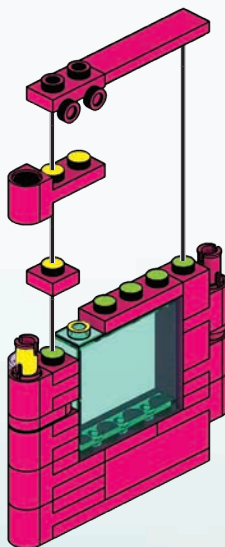

1

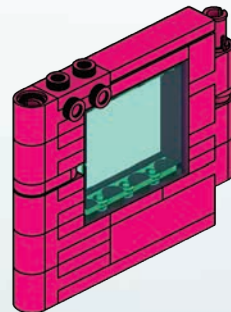

2

84

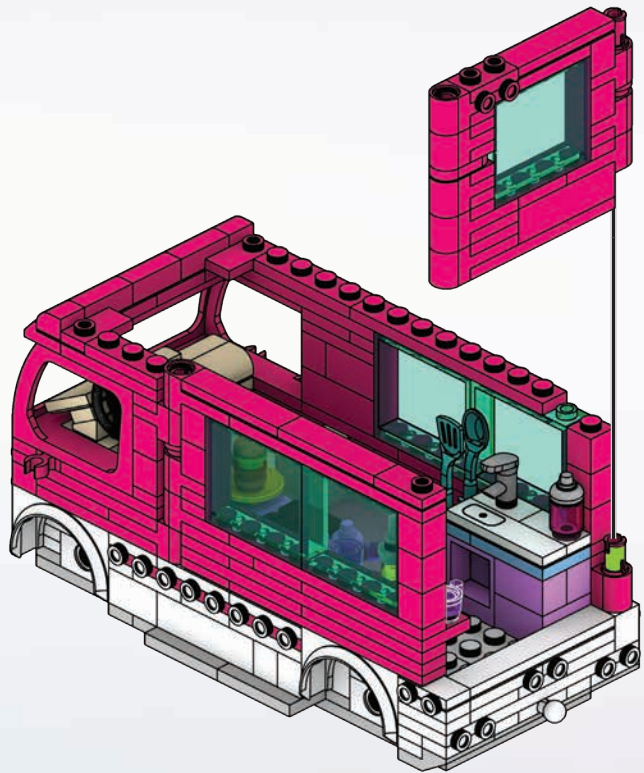

85

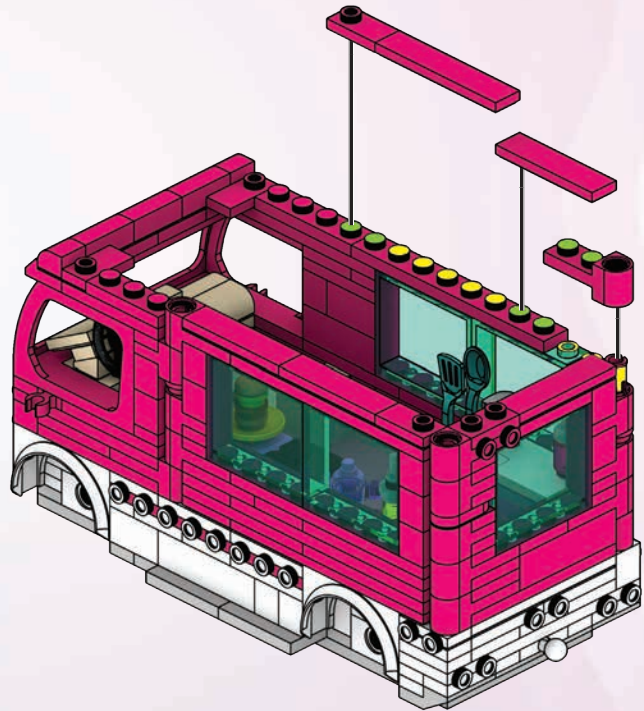
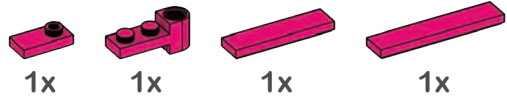

86



4x



2x

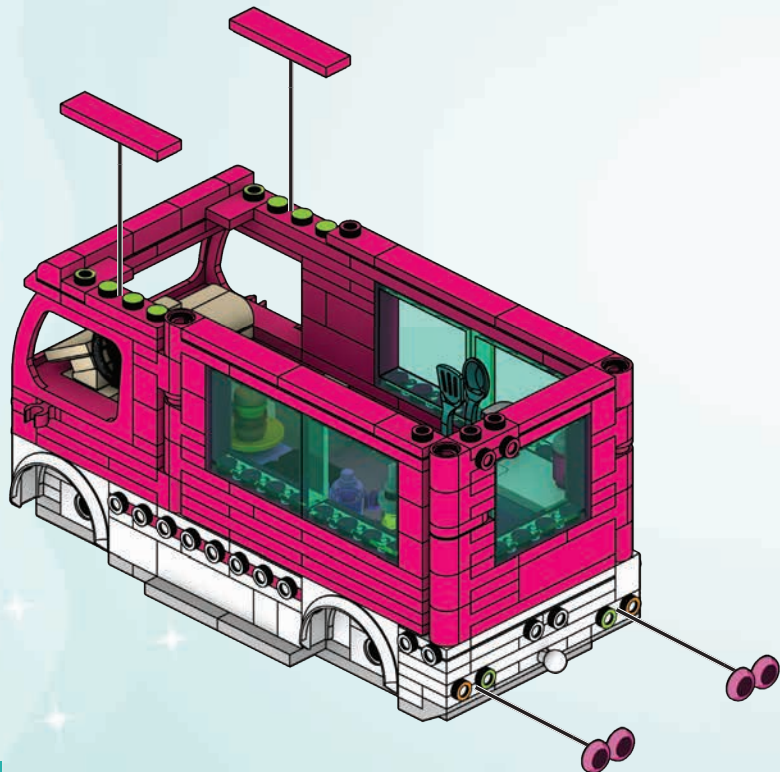

87



2x



1x

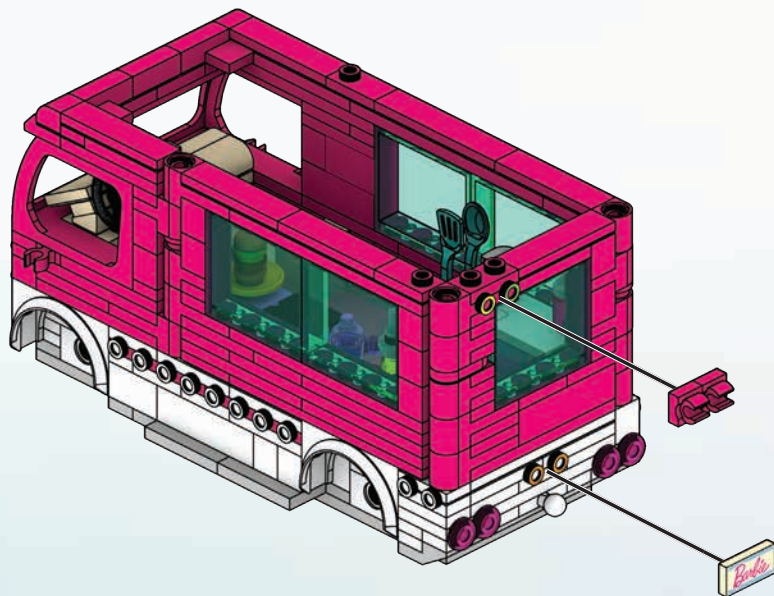

88

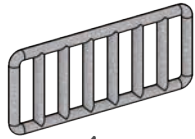

1x

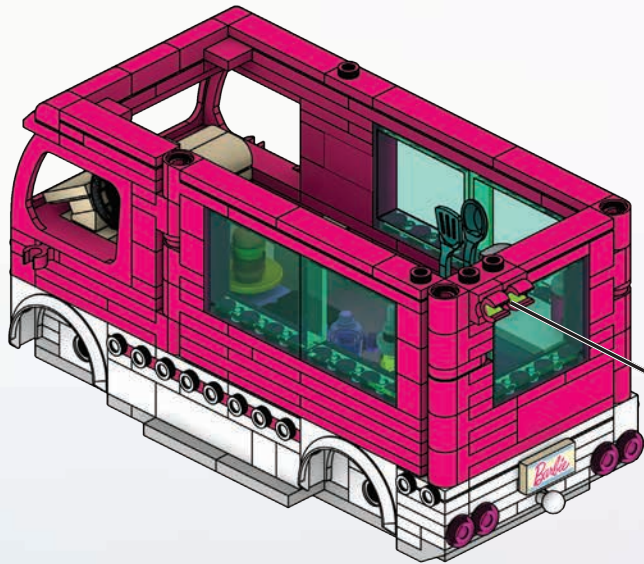

1

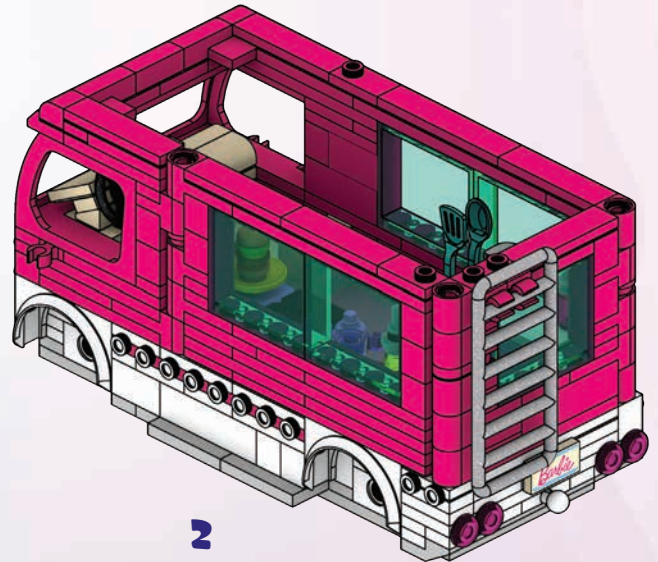

2

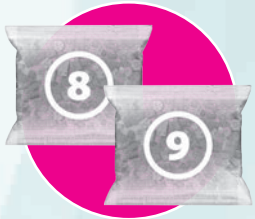

89

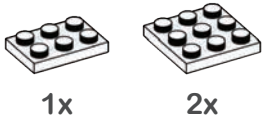

90

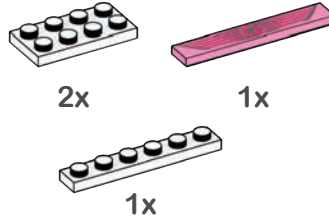

91

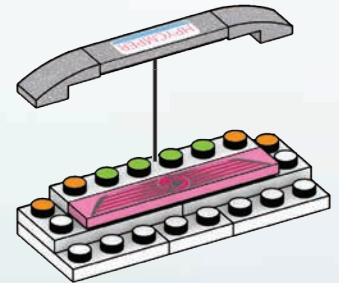
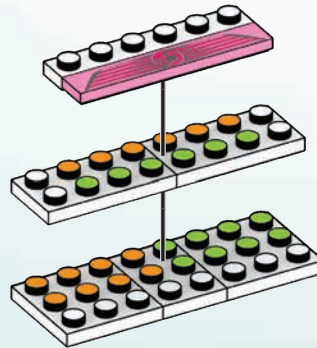
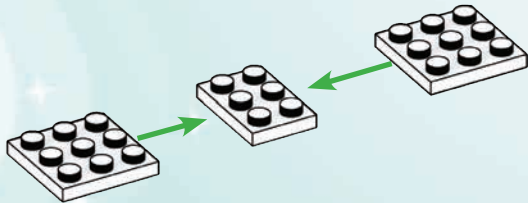
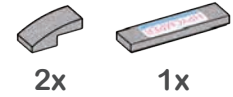

92



2x

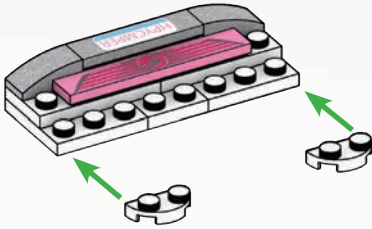

93



2x



2x

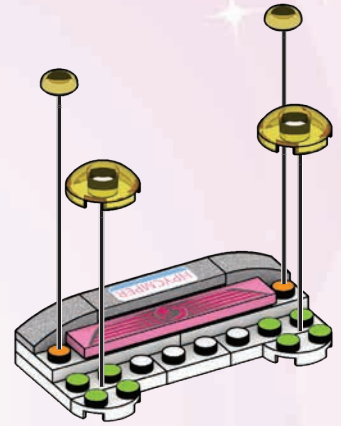

94



2x

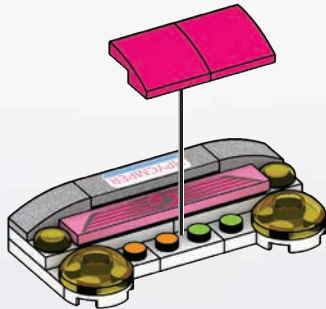

1

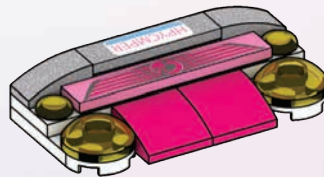

2

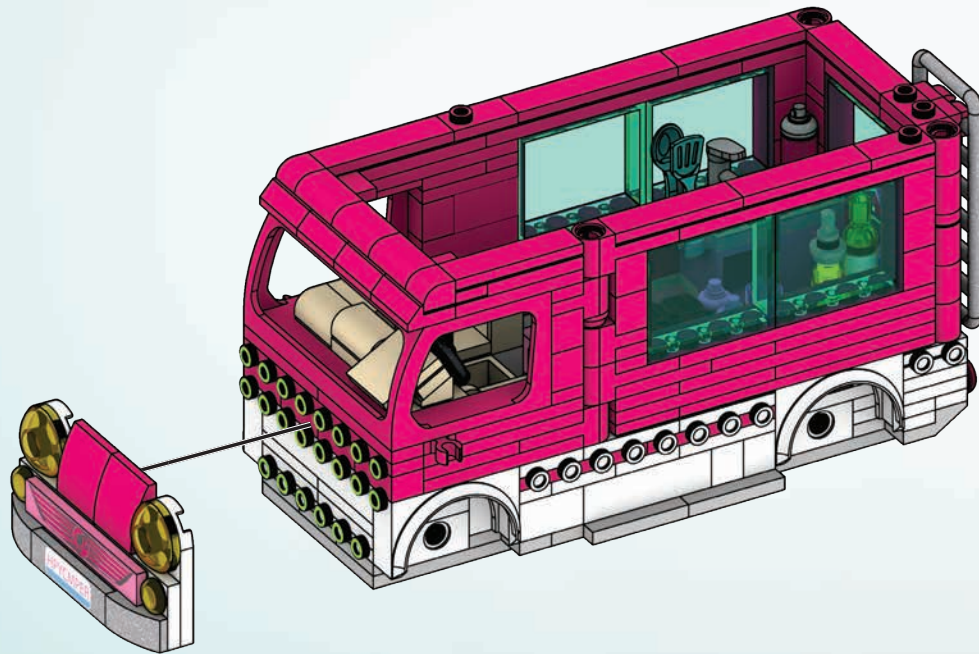

96



2x



2x



2x

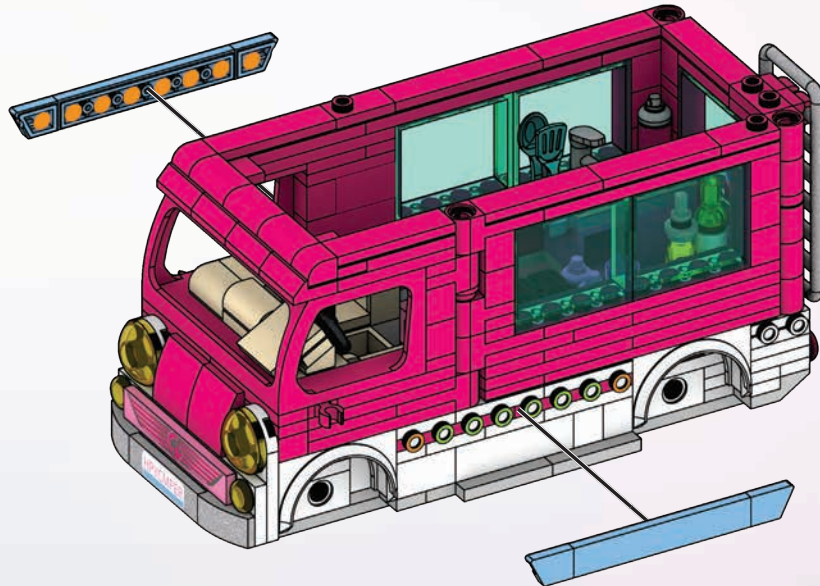

98

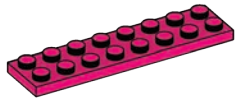

2x

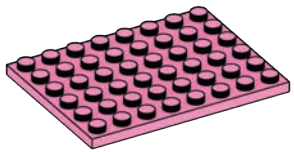

2x

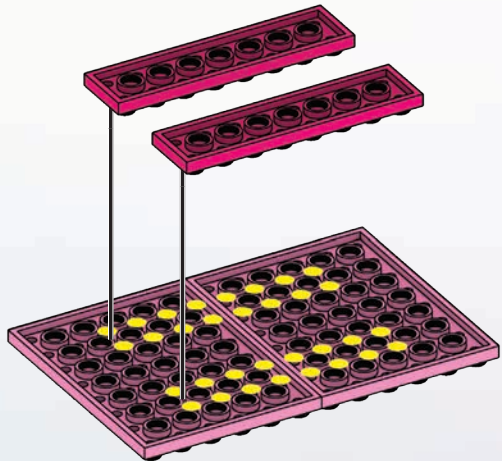

99



1x

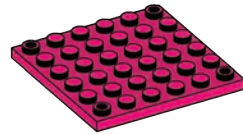

1x

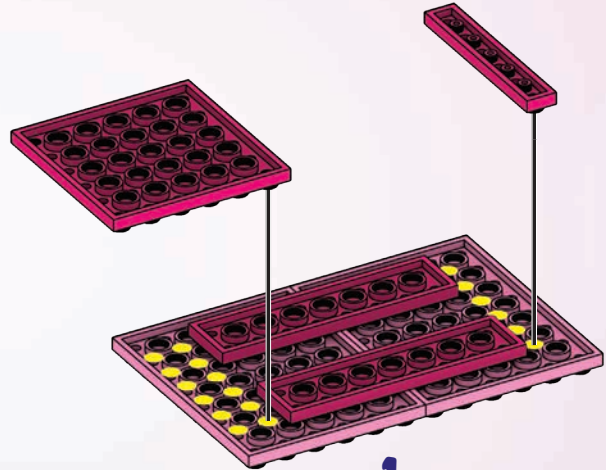

1

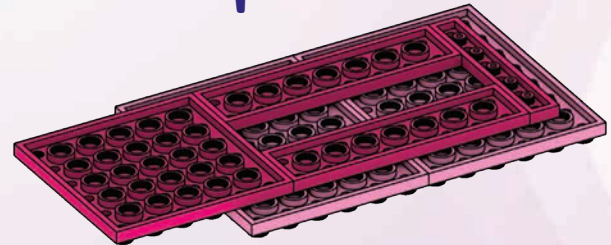

2

100

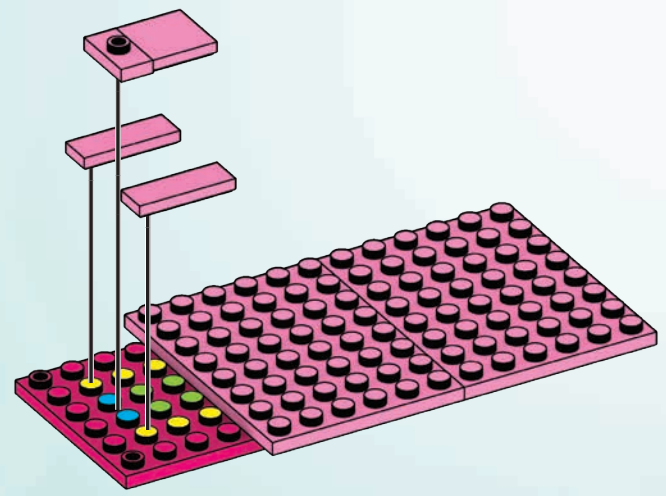

101

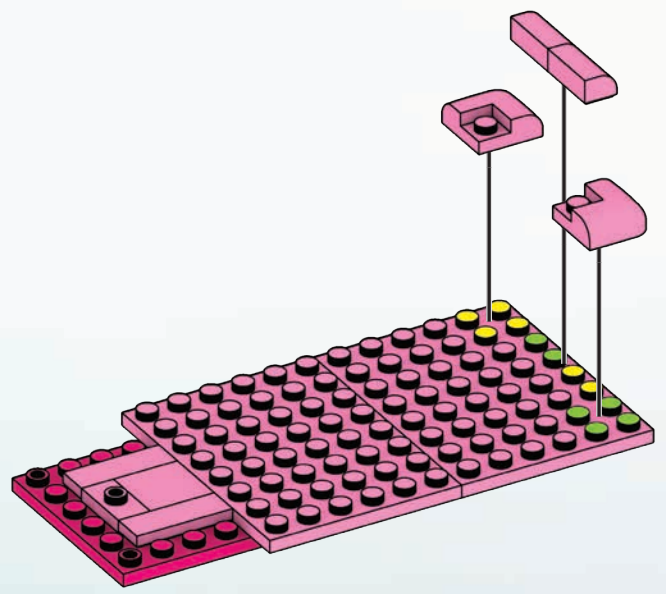
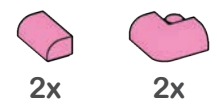

102



1x

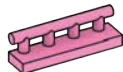

2x

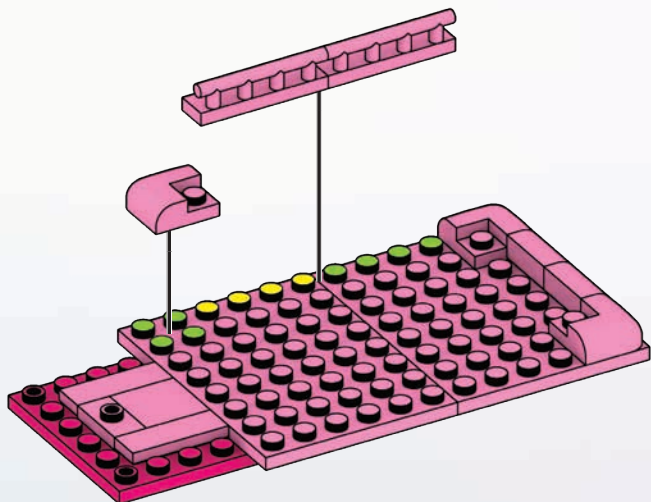

103



2x

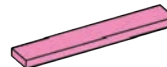

1x

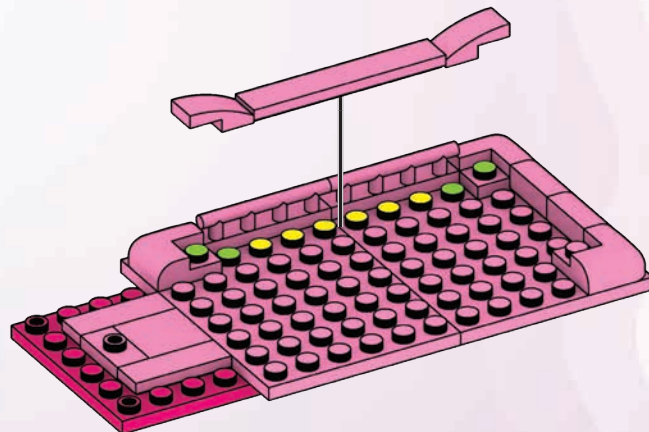

104



2x



1x

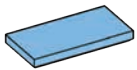

1x

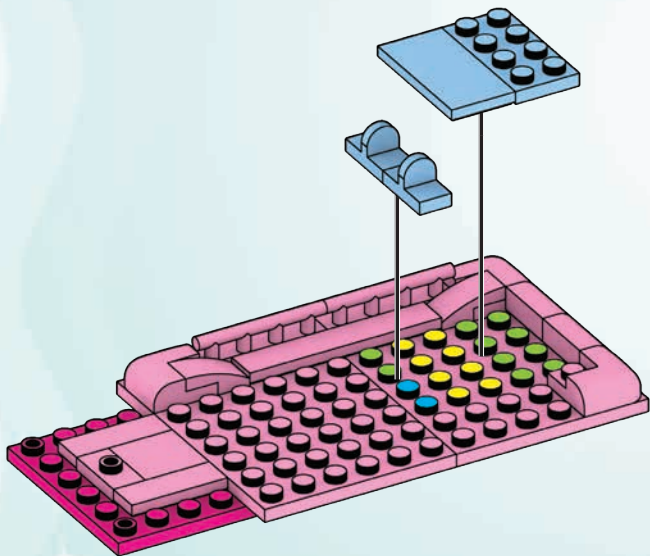

105



1x

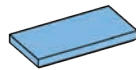

2x

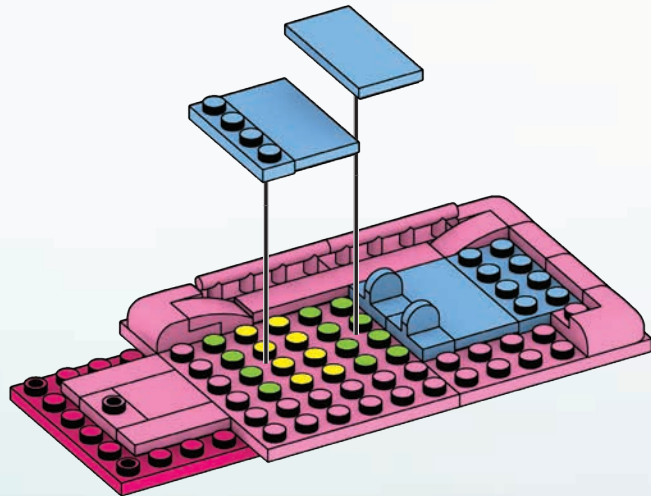

106



4x

107



2x



1x

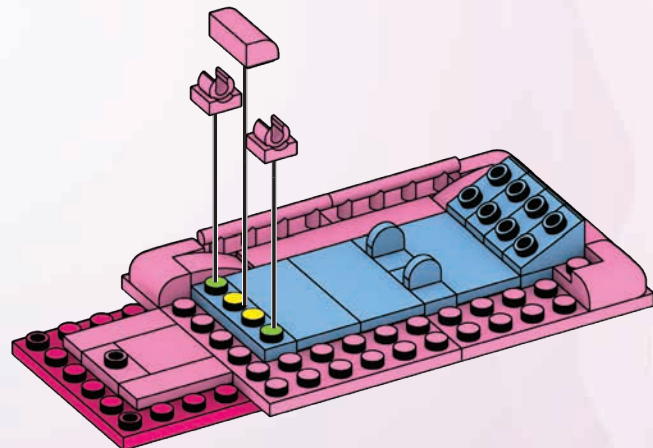
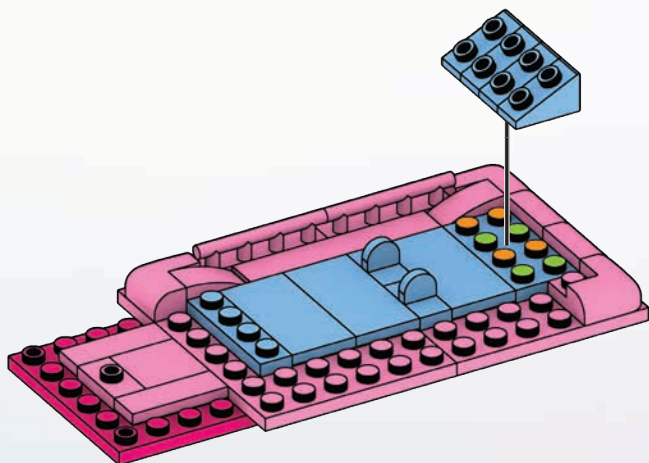

108



2x



1x

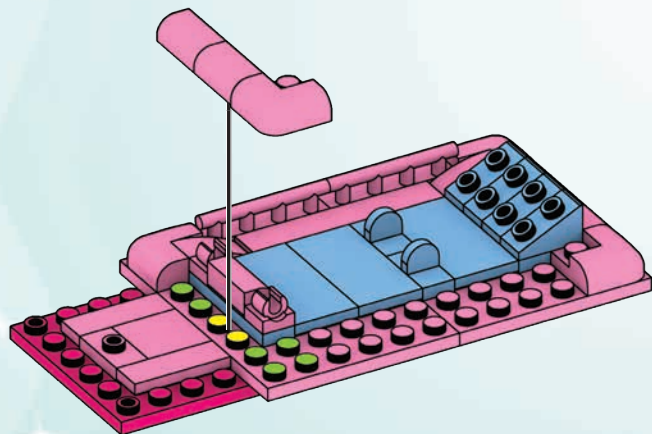

109



2x

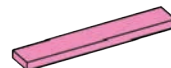

1x

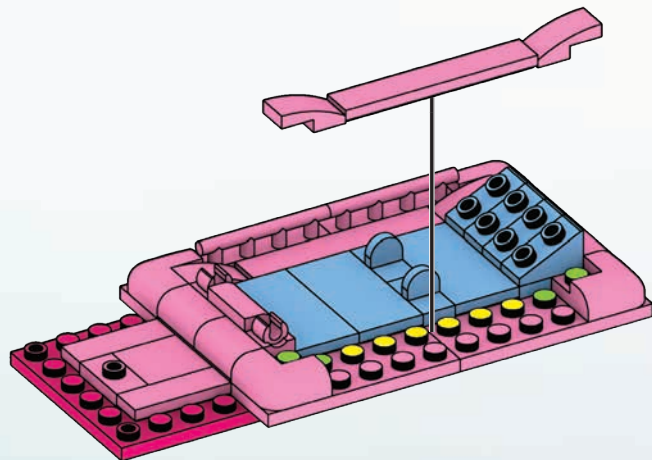

110

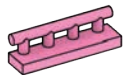

2x

111



2x

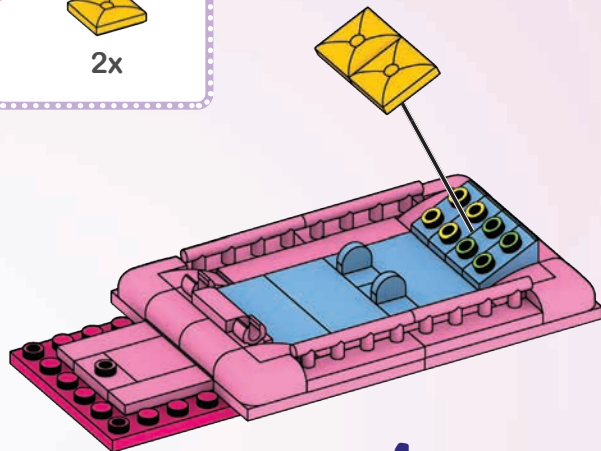
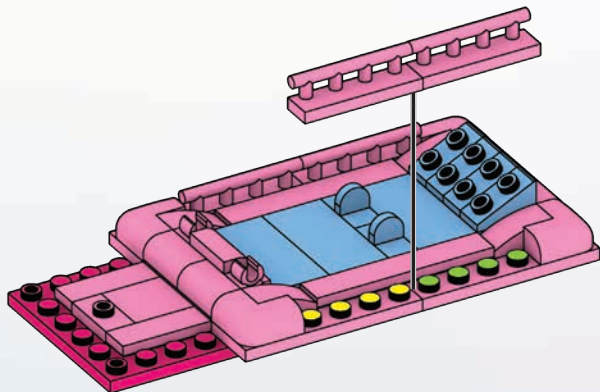

1

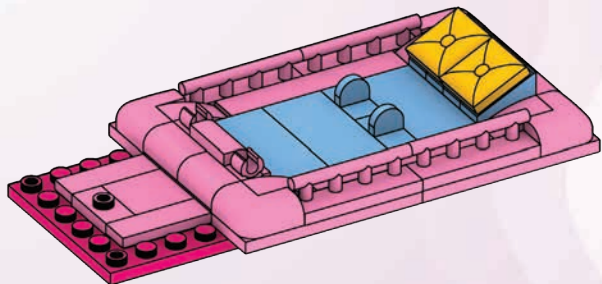

2

112

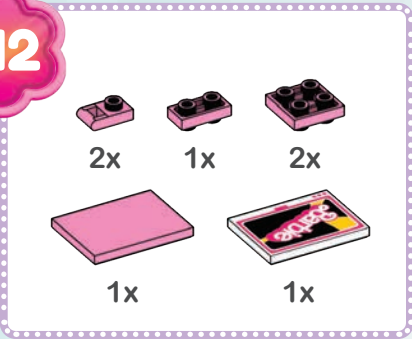

113

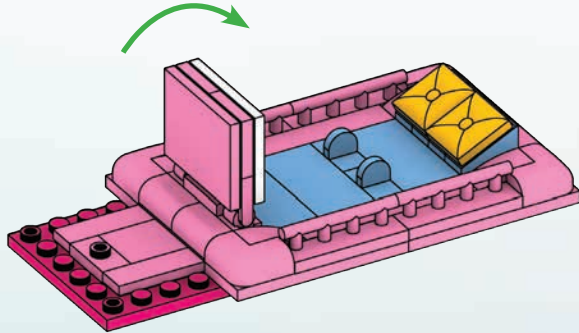
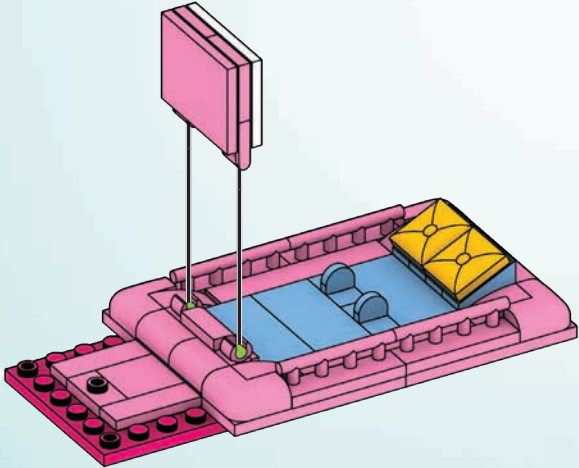

114

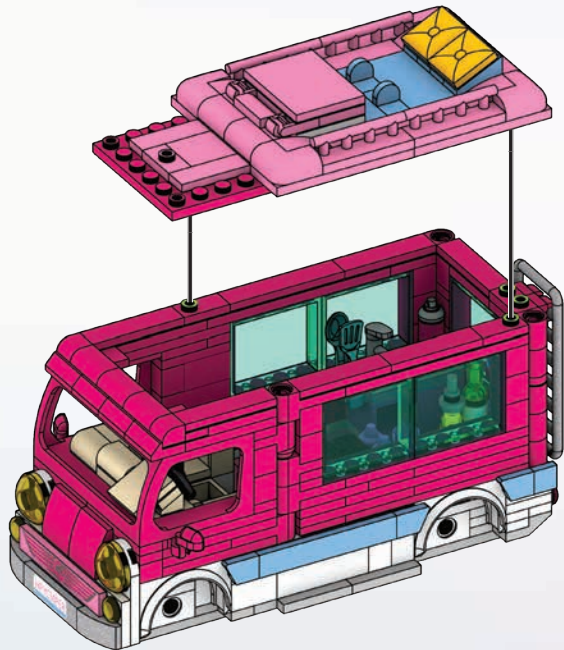

115



4x

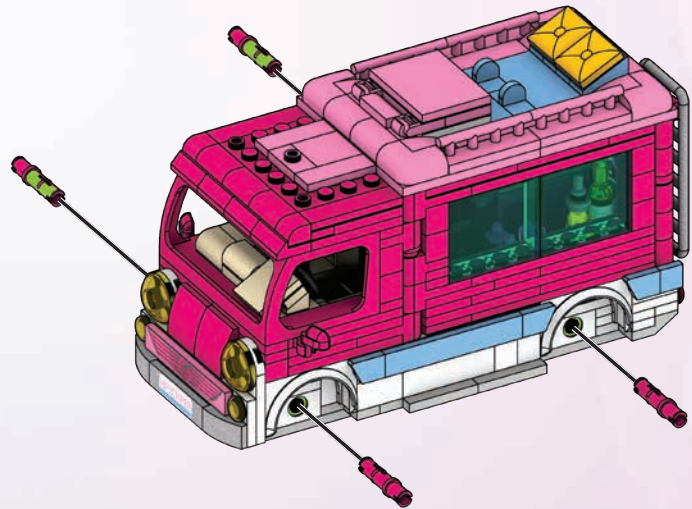

116



4x

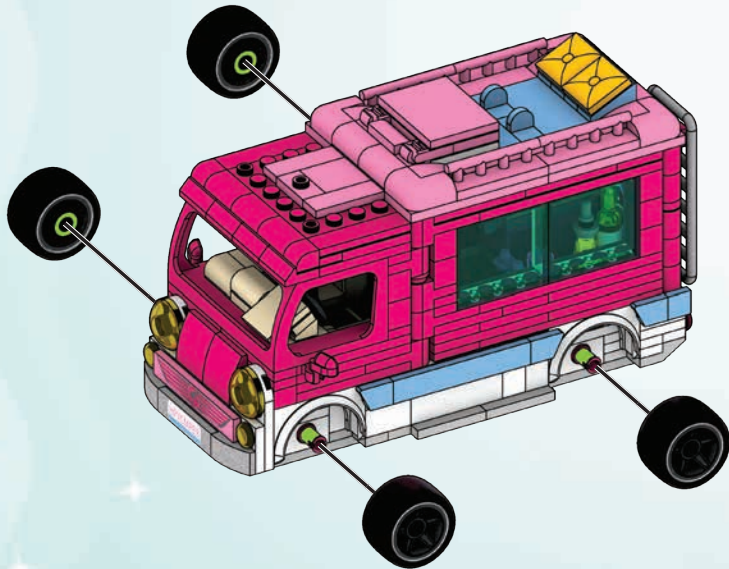

1

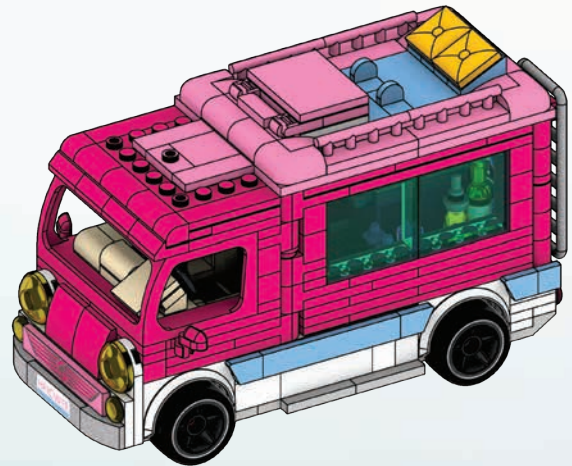

2

LET'S BUILD THE CAMP SITE!

CONSTRUIONS LE
CAMPEMENT !

¡VAMOS A CONSTRUIR EL CAMPAMENTO!

VAMOS CONSTRUIR O ACAMPAMENTO!

DEN CAMPINGPLATZ BAUEN!

ПОСТРОИМ ЛАГЕРЬ!



117

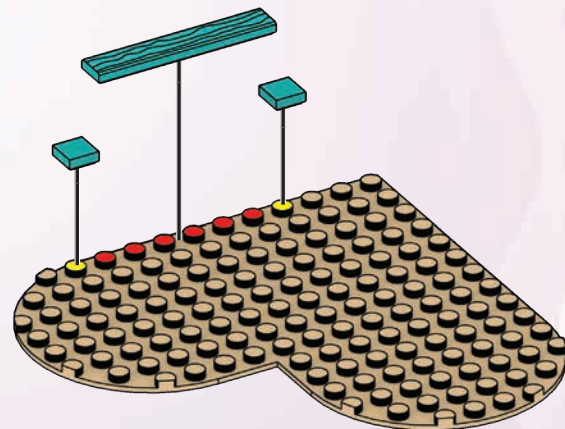
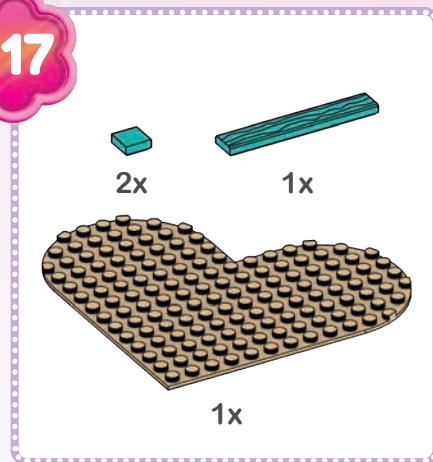

118

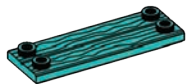

4x

119



2x



1x

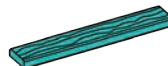

1x

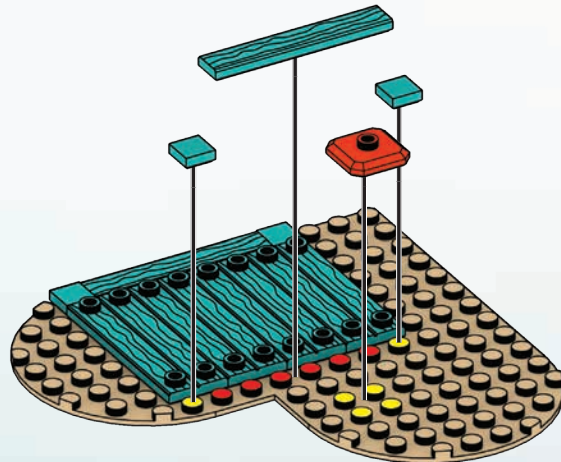
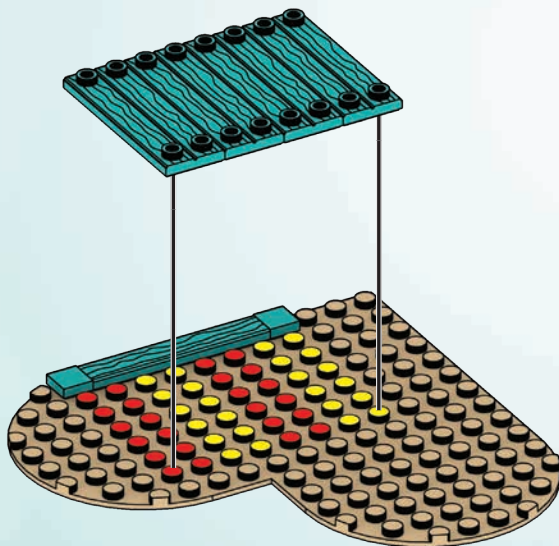

120



4x

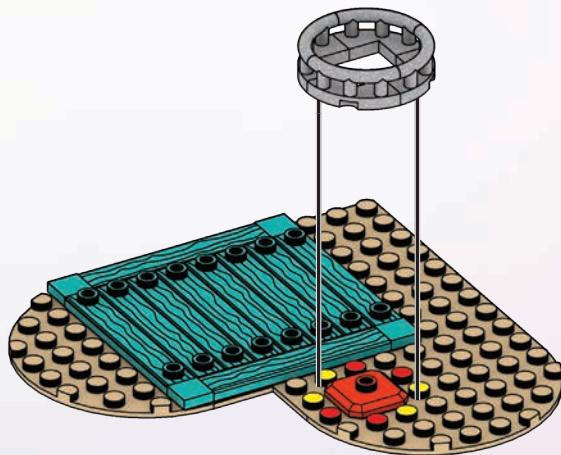

121



1x



1x



1x



1x



1x

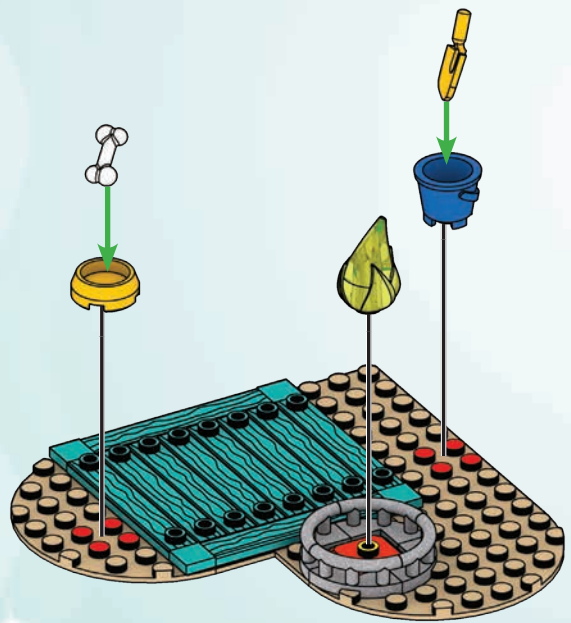

1

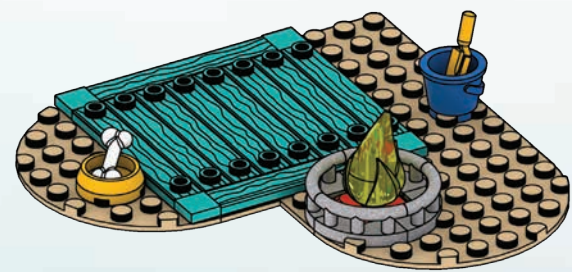

2

122

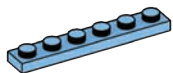

1x

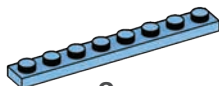

2x



1x

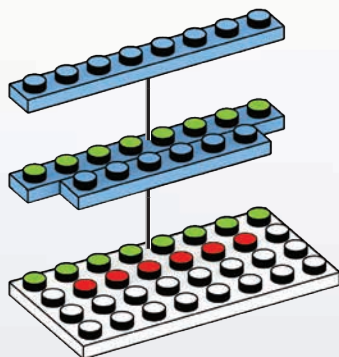

123



4x

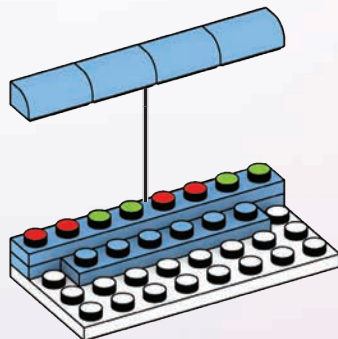

124



2x



2x



2x

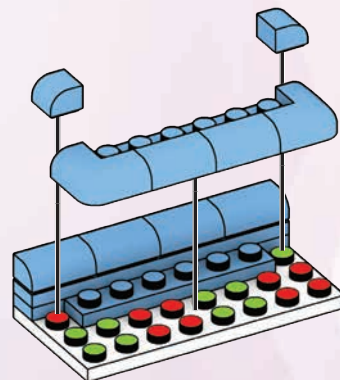

125



2x

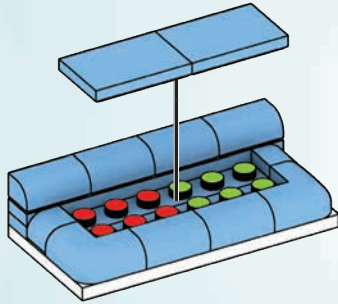

1

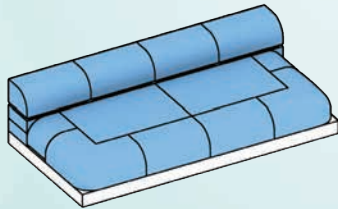

2

126



4x

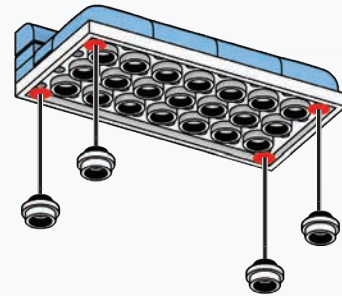

1

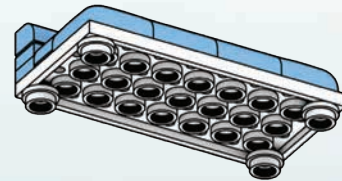

2

127

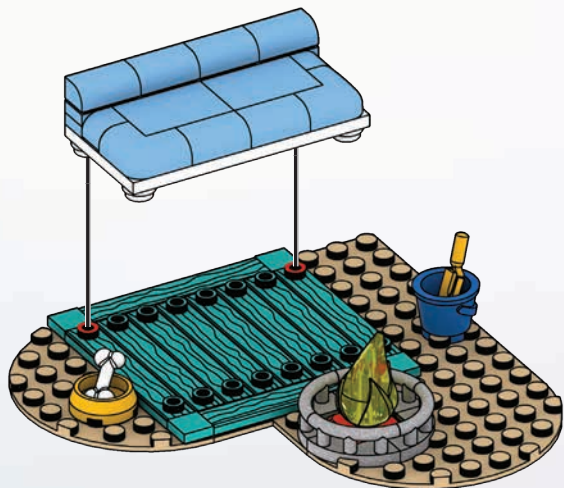

128



3x



129



4x

130



1x



1x



1x



1x

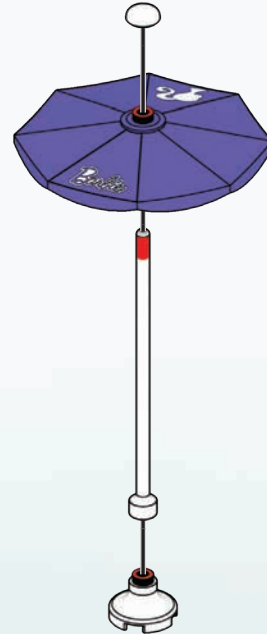

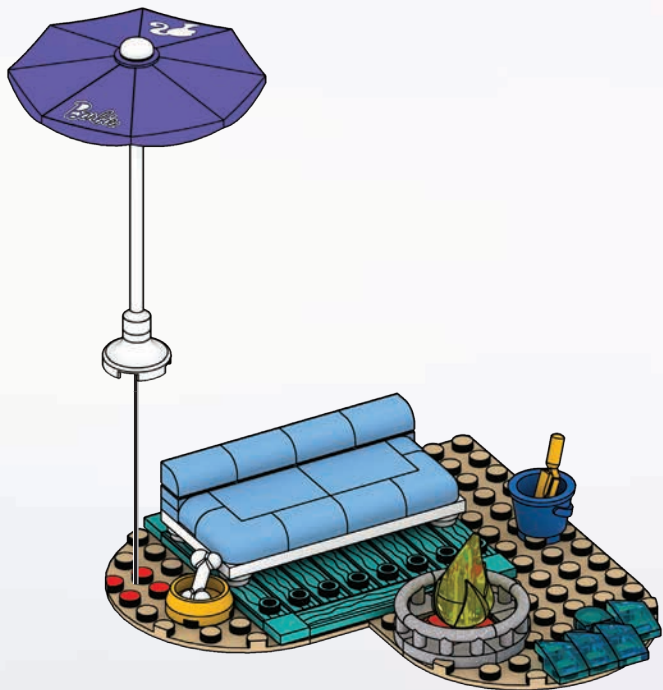

1



2

132



1x



2x

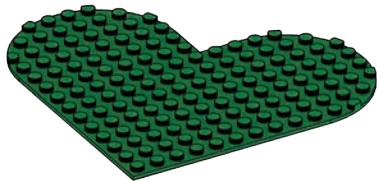

1x

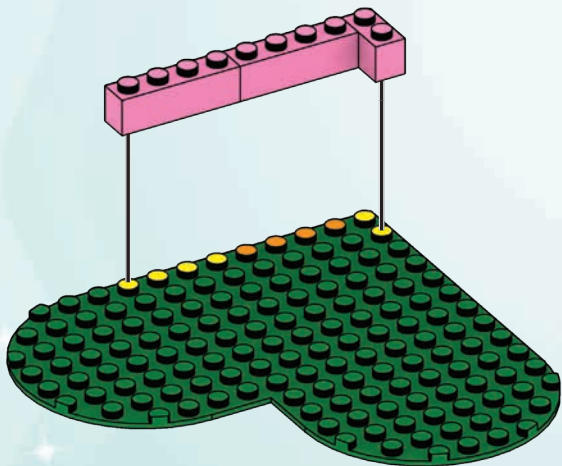

133



2x



2x

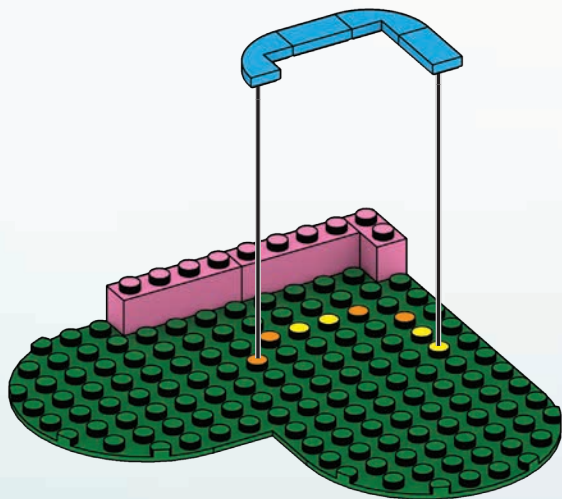

134



2x

2x

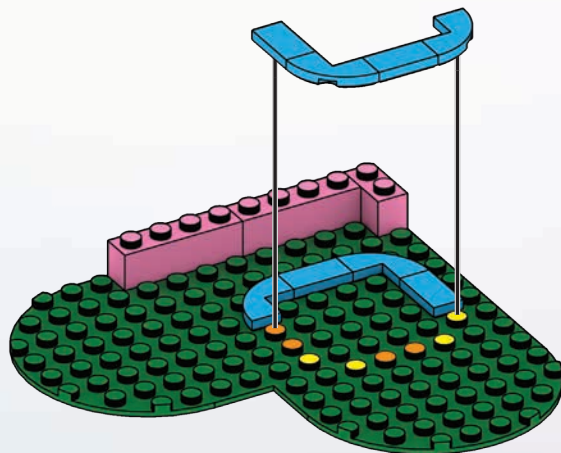

135

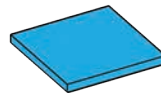

1x

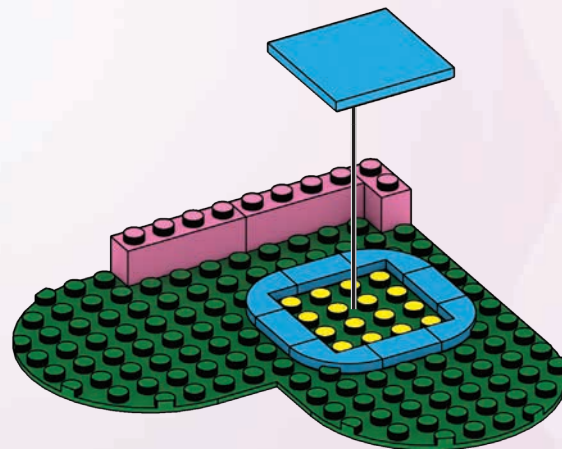

136



1x



1x



2x

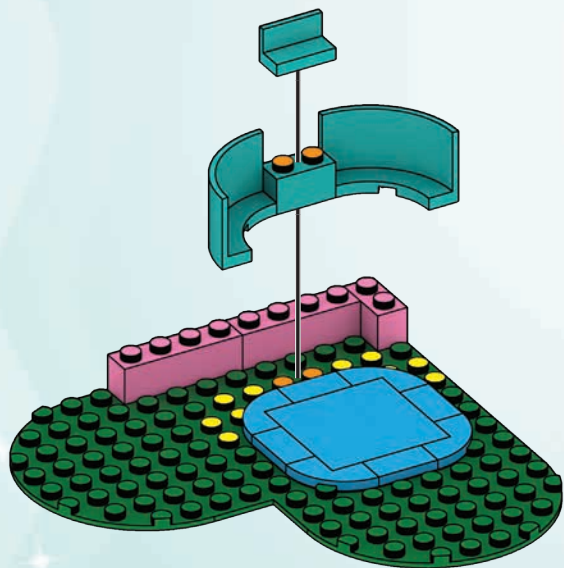

137



2x



2x

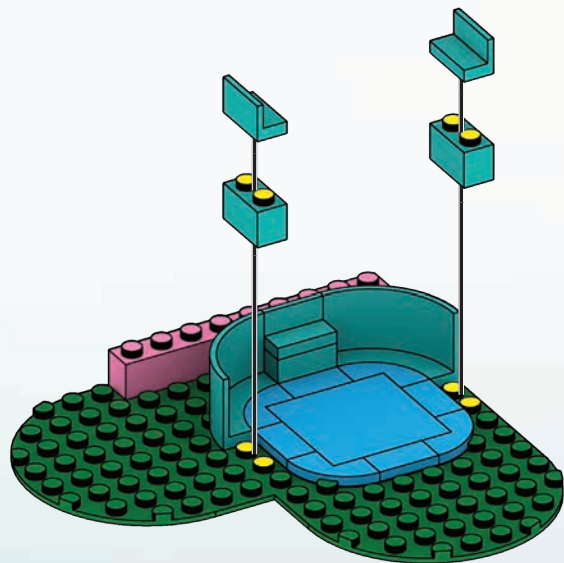

138



1x



1x



2x

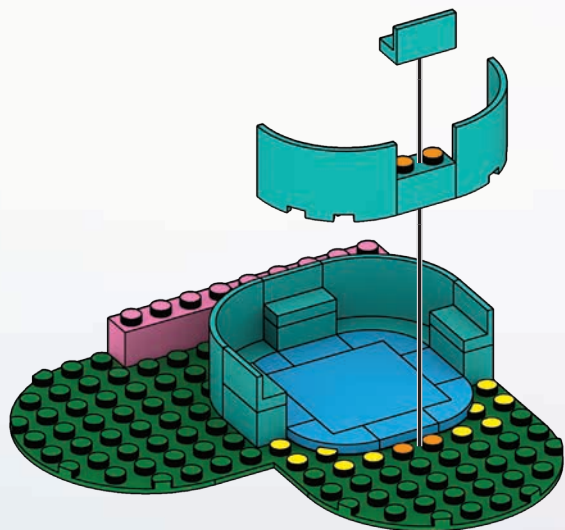

139



2x



1x



1x

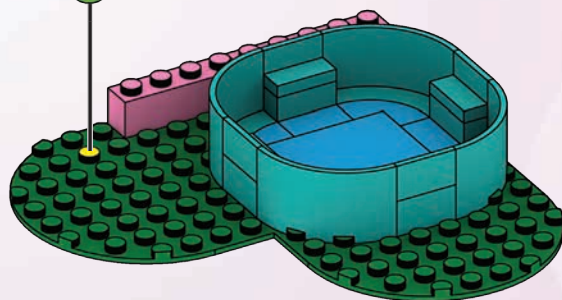
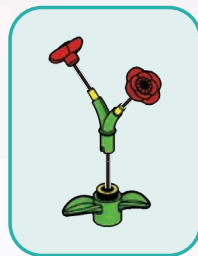

140



1x

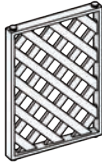

2x

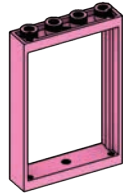

2x

2x

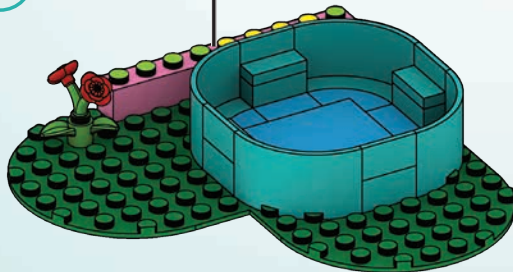
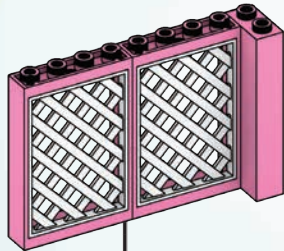
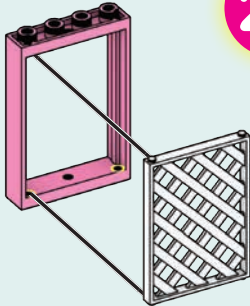

141



2x



1x



1x



142



1x

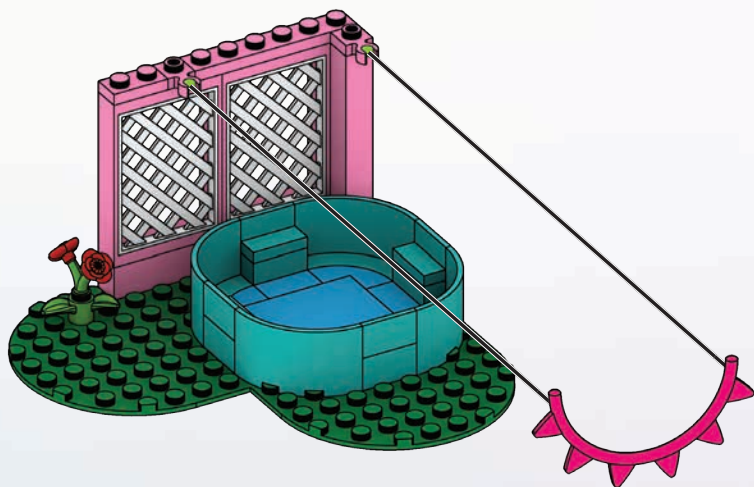

143



10x

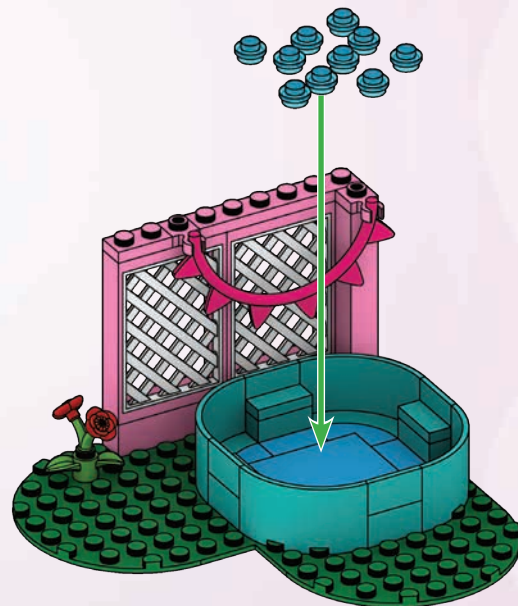

144



1x



2x

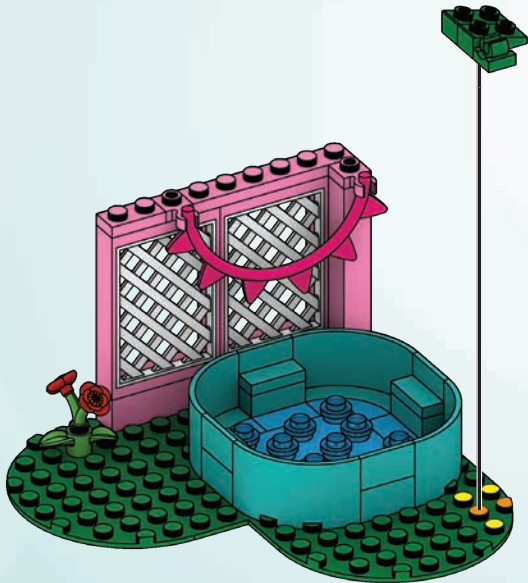

1

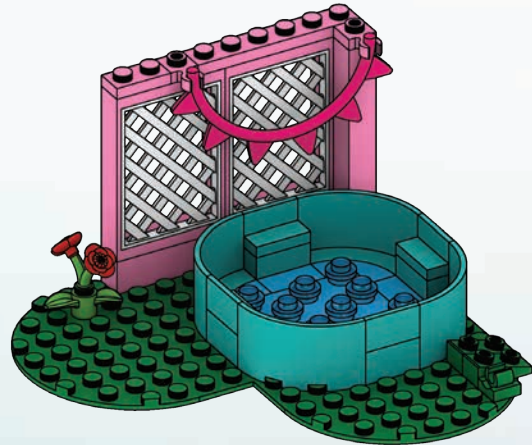

2

145

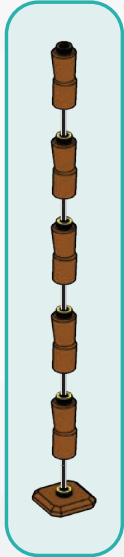

1



2

146



147



1x



1

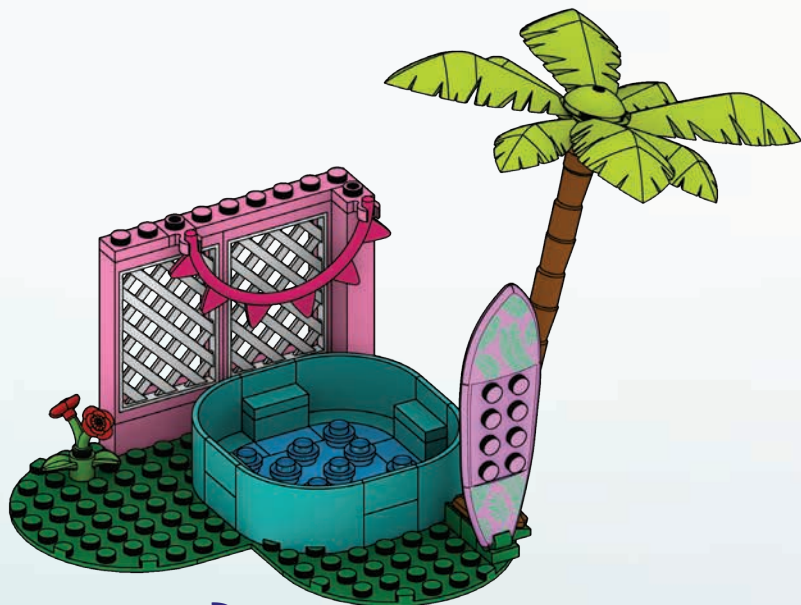

2



148

4x 1x 1x

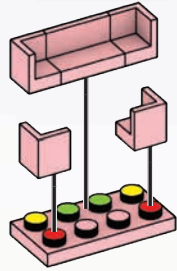

149

4x

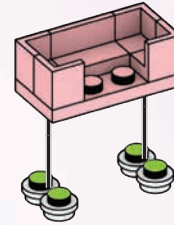

1

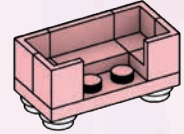
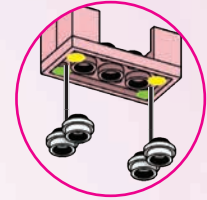

2

150

2x 1x 1x 2x

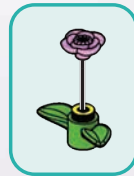
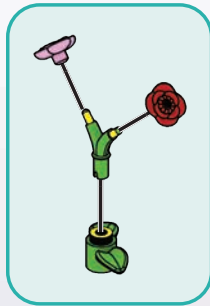

1



2



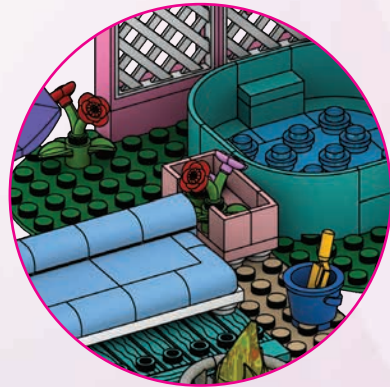

153

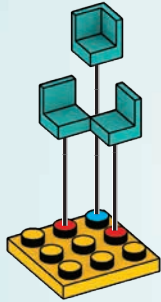
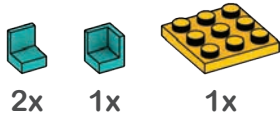

154

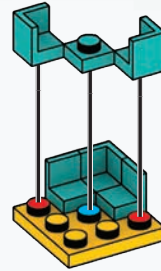
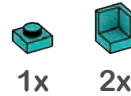

155

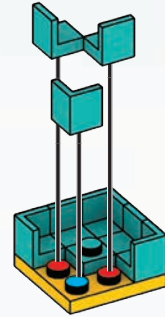
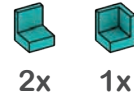

156

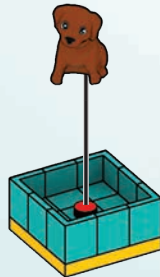

157



2x



158



1x

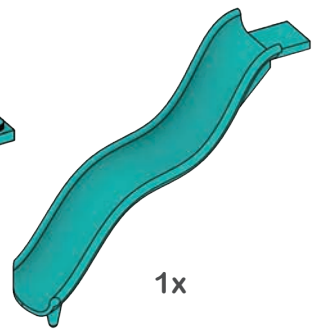

1x

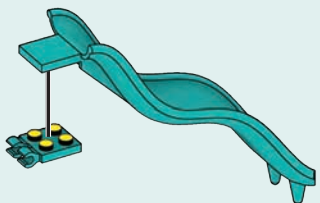

1

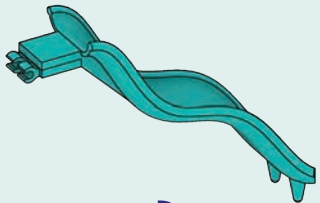

2

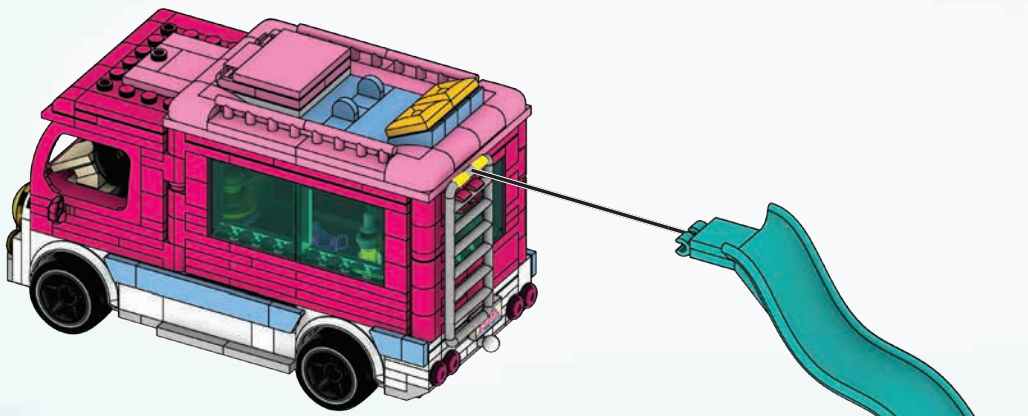

1

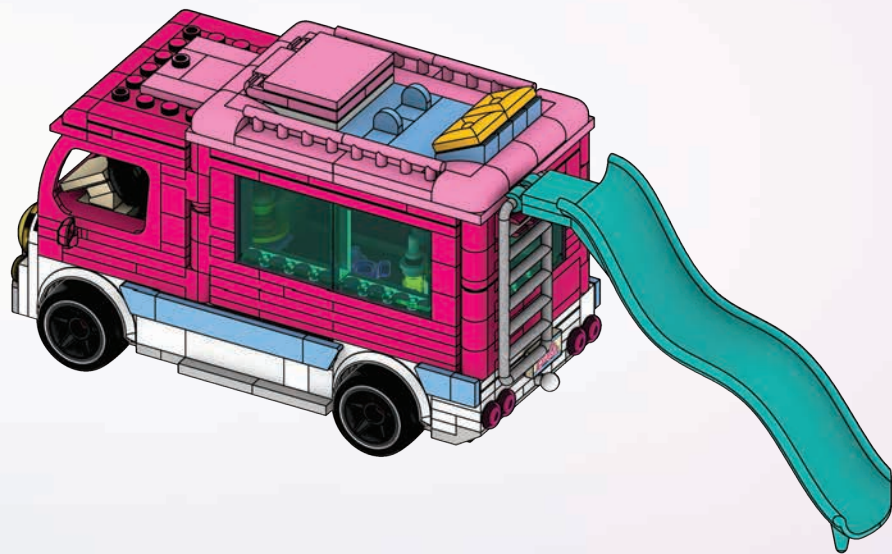

2

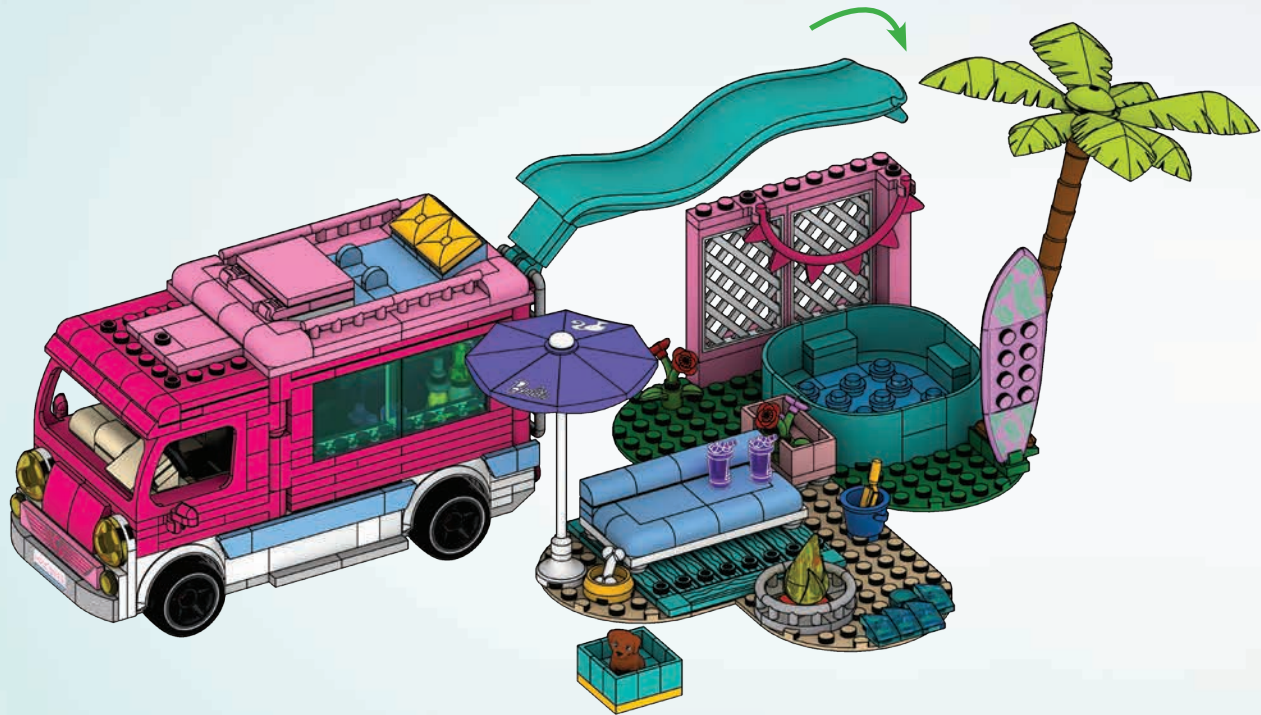



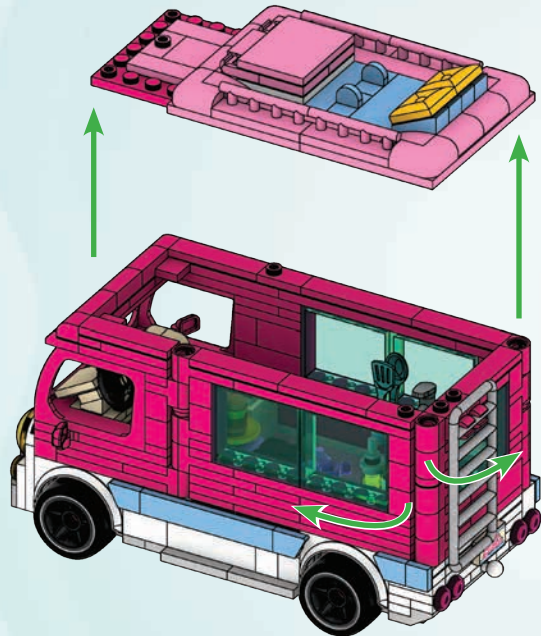

1

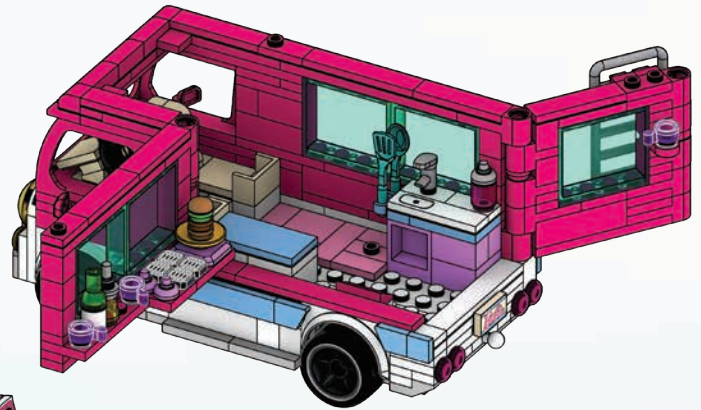

2

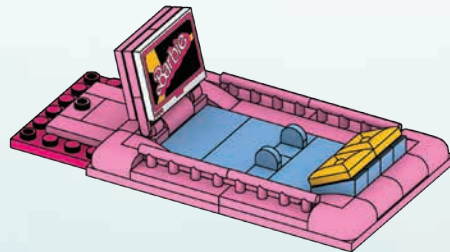

LET'S PLAY!
AMUSONS-NOUS!
IAJUGAR! - A BRINGAR!
LASS UNS SPIELEN! - НАЧИНАЕМ ИГРУ!



Dream Camper Adventure™ • Aventure en Camping-car de Rêve
Cámpers de los Sueños • Trailer Dos Sonhos • Barbie Camper dei Sogni • Super Abenteuer-Camper
Przygodowy Wymarzony Kamper • Avonturen met Droomcamper • Фургон для путешествий • Τροχόσπιτο - Σετ
Rüya Karavanı Maceraları • مغامرة Dream Camper Adventure

1x AM17003APG
 1x AM74397WH
 2x AM81718ATC
 1x AM75332E
 2x AM75332AXN
 1x AM75332VL
 4x AM75332AXF
 8x AM01113E
 10x AM01113AAV
 1x AM01113MY
 1x AM01113VL
 1x AM01113JS
 2x AM01113ATC
 1x AM18560APG

2x AM72970ASY
 1x AM72970APG
 1x AM78802WH
 1x AM15026MM
 3x AM76204AAV
 4x AM07223CV
 2x AM07223I
 1x AM03328CV
 4x AM03328E
 13x AM03328ATC
 3x AM72954AMC
 2x AM72954ASY
 4x AM81546AAV

1x AM19999BMG
 2x AM19999ATC
 2x AM19999ASX
 4x AM15485CV
 4x AM76959NU
 4x AM76959CV
 2x AM17787I
 2x AM17787ATC
 1x AM00910E
 1x AM00910AUZ
 13x AM01086ATC

2x AM18591ASX
 2x AM18591ATC
 2x AM18591I
 2x AM76054ASX
 3x AM74299I
 3x AM74300I
 2x AM78722HT
 1x AM72973E
 5x AM78953MY
 1x AM72931APG
 3x AM79638KF
 2x AM73035KF

1x AM74414HQ
 2x AM79375E
 4x AM22501GD
 1x AS-HPN80-03
 2x AM22501ASX
 1x AM22501ATC
 1x AM73758ASX
 4x AM73758ATC
 2x AM73758E
 2x AM07590ASX
 2x AM07590WC
 1x AM07590E

1x AM09393ASX
 4x AM09393BLG
 3x AM09393E
 8x AM09393ATC
 1x AM09393ASY
 1x AM16680ASX
 4x AM79070E
 2x AM76467E
 1x AM76467ATC
 1x AM18221WC
 1x AM78397E

2x AM81861I
 2x AM81861WC
 1x AM07228NU
 4x AM07228CV
 6x AM81806ATC
 3x AM81095WC
 2x AM78285AXN
 1x AM79679BBG
 1x AM81384MM
 1x AM72908E
 1x AM72972HQ

1x AM18272WC
 2x AM80573BMG
 4x AM04429I
 2x AM78486APG
 4x AM78486ASX
 1x AM18549ATC
 4x AM03017I
 3x AM03017WC
 3x AM03017ATC
 5x AM03017ASX

1x AM78712BYE
 3x AM78726HT
 4x AM09013CV
 1x AM09013ASX
 4x AM09013E
 2x AM09013ATC
 1x AM09013ASY
 1x AM17502E
 8x AM79877E
 4x AM81353ATC

1x AM81215Z
 1x AM74401ATC
 1x AM74400ATC
 6x AM72534ATC
 4x AM18667GD
 1x AM78381AMZ
 1x AM73974HP
 1x AM81848MY
 2x AM81473I
 2x AM81474I
 4x AM81474ASX

1x
AM16972ATC

8x
AM15484E

4x
AM15484BLG

4x
AM09835ATC

4x
AM18223BLG

2x
AM17153E

3x
AM00948WC

2x
AM00948ASX

2x
AM72956HQ

1x
AM17836AYB

1x
AM73009MCX

1x
AM73009MY

1x
AM73009WC

1x
AM73009ASY

4x
AM03773E

1x
AM03773ATC

5x
AM03773WC

2x
AM01146ASX

2x
AM09023WC

1x
AM09023ASY

1x
AM03872ASY

1x
AS-HPN80-07

2x
AM74106ATC

4x
AM18265ATC

4x
AM09270APG

9x
AM78107ATC

3x
AM16384ATC

1x
AM18328CV

2x
AM01314E

4x
AM80966ASX

6x
AM81260E

1x
AM03772E

1x
AM03772ATC

1x
AM03772I

2x
AM81639I

2x
AM03873E

4x
AM74139BLG

2x
AM01087ASX

3x
AM01087ATC

1x
AM01087ASY

12x
AM09593ATC

1x
AM09593I

1x
AS-HPN80-02

1x
AS-HPN80-04

6x
AM09838ATC

4x
AM01847ASX

1x
AM09493NU

2x
AM09493E

6x
AM09033E

8x
AM81163E

1x
AM81163HQ

1x
AM81163ATC

1x
AM09493WC

1x
AM09493I

4x
AM77463I

1x
AS-HPN80-05

4x
AM07475ATC

1x
AM17793ATC

1x
AM72025ASX

1x
AM78728GD

3x
AM80965ATC

2x
AM01313E

1x
AM01480E

4x
AM17395E

5x
AM19648AQX

1x
AM81496ASX

4x
AS-HPN80-10

4x
AM81855CV

2x
AM78723E

2x
AM76416ASX

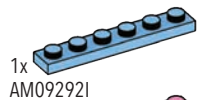

1x
AM09292I

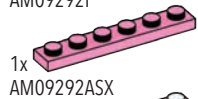

1x
AM09292ASX



2x
AM09292E



4x
AM09292ATC



2x
AM09292BLG

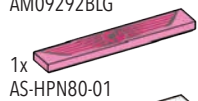

1x
AS-HPN80-01



1x
AM16331E

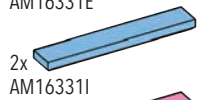

2x
AM16331I

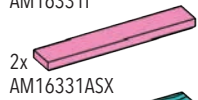

2x
AM16331ASX

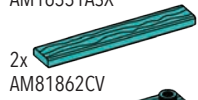

2x
AM81862CV

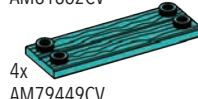

4x
AM79449CV



4x
AM08483E

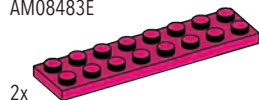

2x
AM08483ATC

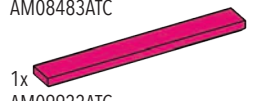

1x
AM09922ATC



1x
AM19383APG

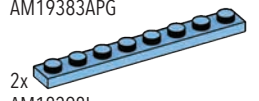

2x
AM18298I

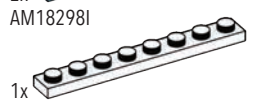

1x
AM18298E

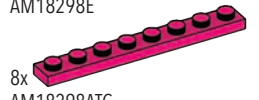

8x
AM18298ATC



1x
AM09323E



1x
AS-HPN80-08



1x
AS-HPN80-06

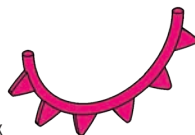

1x
AM81162ATC



4x
AM81847BBG

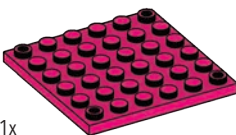

1x
AM74681ATC



1x
AM17845E



1x
AM09923BLG

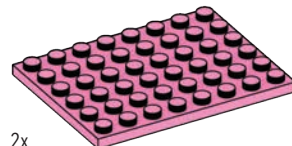

2x
AM74678ASX

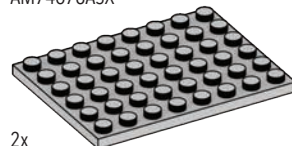

2x
AM74678BLG

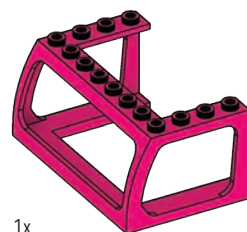

1x
AM81807ATC

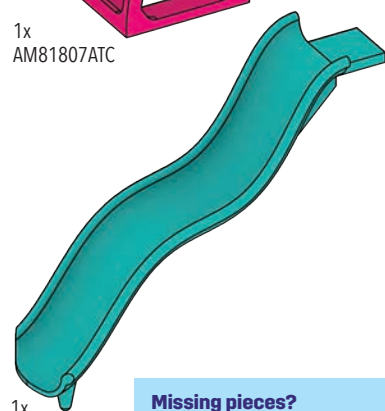

1x
AM81497CV

**Missing pieces?
Pièces manquantes?**

¿Partes faltantes? • Perdeu peças?
Fehlen Teile? • Не хватает деталей?

support.megabrands.com



1x
FIG-HPN80-A



1x
FIG-HPN80-B



1x
FIG-HPN80-C



1x
FIG-HPN80-D



1x
AM81839AMP



1x
AM81838E



1x
AM81840E



1x
FIG-HPN80-E



1x
AM81873RQ



1x
AM81872GD

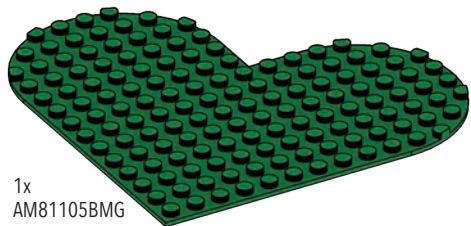
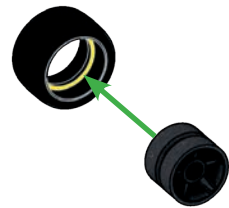

1x
AM81105BMG



1x
AM15025MM



1x
AM73027CV

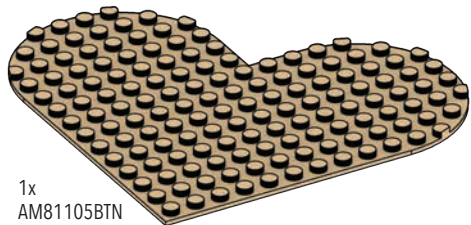

1x
AM81105BTN



1x
AM73028CV

⚠ WARNING: Small parts, ADVERTENCIA: PELIGRO DE ATAGANTAMIENTO. Juguete no recomendado para menores de 3 años, porque contiene piezas pequeñas que podrían provocar asfixia en caso de ser ingeridas o inhaladas por el/la niño/a, AVVERTENZA: Piccole parti, ACHTUNG: Kleine Teile, OSTRZEZENIE: Małe części, WAARSCHUWING: Kleine onderdelen, ПРЕДУПРЕЖДЕНИЕ: Маленькие детали, ADVARSEL: Små dele, VARNING: Små delar, VAROITUS: Pieniä osia, ΠΡΟΕΙΔΟΠΟΙΗΣΗ: Μικρά κομμάτια, UYARI: Küçük parçalar, UPOZORNĚNÍ: Malé části, UPOZORNENIE: Malé časti, FIGYELMEZTETÉS: Kis alkatrészek.



ATTENTION : PETITS ÉLÉMENTS.
ATENÇÃO!

NÃO INDICADO / NÃO RECOMENDÁVEL PARA CRIANÇAS MENORES DE 3 (TRÊS) ANOS POR CONTER PARTE(S) PEQUENA(S) QUE PODE(M) SER ENGOLIDA(S) OU ASPIRADA(S) PODENDO PROVOCAR ASFIXIA.

警告: のどにつまる危険 小さな部品が含まれています 3歳以下の子供には与えないで下さい。

警告! 不适合3岁以下儿童使用。内含小零件。

تحذير: قطع صغيرة.

Mattel Europa B.V., Gondel 1, 1186 MJ Amstelveen, Nederland. Mattel U.K. Limited, The Porter Building, 1 Brunel Way, Slough SL1 1FQ, UK. Mattel France, Parc de la Cerisaie, 1/3/5 allée des Fleurs, 94260 Fresnes Cedex. N° Cristal 0969 36 99 99 (Numéro non surtaxé) ou www.lesjouetsmattel.fr Mattel Belgium, Trade Mart, Atomiumsquare, Bogota 202 - B 275, 1020 Brussels. Gratis nummer België: 0800 - 16 936 - Gratis nummer Luxemburg: 800 - 22 784 - Gratis nummer Nederland: 0800 - 262 88 35. Deutschland: Mattel GmbH, Solmsstraße 83, D-60486 Frankfurt am Main. Schweiz: Mattel AG, Kirchstrasse 24, CH-3097 Liebefeld. Österreich: Mattel Ges.m.b.H., Campus 21, Liebermannstraße A01 404, A- 2345 Brunn/Gebirge. Mattel Italy Srl, Via Turati 4, 20121 Milano, Italy. Servizio assistenza clienti: Customersrvitalia@mattel.com - Numero verde 800 11 37 11. Mattel España, S.A., Arribau 200 pl. 9, 08036 Barcelona. cservice.spain@mattel.com Tel: +34 933 06 79 00 http://www.service.mattel.com/es. Mattel East Asia Ltd., Room 503-09, North Tower, World Finance Centre, Harbour City, Tsimshatsui, HK, China. Tel: (852) 3185-6500. Diimport & Diedarkan Oleh: Mattel Continental Asia Sdn Bhd. Level 19, Tower 3, Avenue 7, No. 8 Jalan Kerinci, Bangsar South, 59200 Kuala Lumpur, Malaysia. Mattel South Africa (PTY) LTD, Office 102 I3, 30 Melrose Boulevard, Johannesburg. Distributor: Mattel Poland Sp. z o.o., Warsaw Trade Tower 34 p., ul. Chłodna 51, 00-867 Warszawa. Mattel Australia Pty. Ltd., 658 Church St., Richmond, Victoria, 3121. Consumer Advisory Service - 1300 135 312. Mattel AEBE, Εβδούρου Μακαρίου 1, Κτήριο K-2, ΤΚ 17561, Παλαιό Φάληο. Mattel Oyuncakçılık Tic. Ltd. Şti. İçerenköy Mah., Umut Sokak No: 10 - 12, Quick Tower kat:2 içkapı no:15 Ataşehir 34752, İstanbul, Türkiye. Tel: 0216 570 75 00. Импортёр/Уполномоченная организация: ООО "МАТТЕЛ" Российская Федерация, 105120 Москва, 2-й Сыромлягинский переулок 1, +7 495 287 79 39. Mattel Czech Republic s.r.o., The Forum, Václavské nám. 19, 11000 Praha 1. Mattel, 333 Continental Boulevard, El Segundo, CA 90245, USA. Consumer Services: 1-800-465-MEGA (6342). Mattel Canada Inc., Mississauga, Ontario L5R 3W2. Consumer Services: You may call us free at/ Composez sans frais le 1-800-524-8697. Importado y distribuido por Mattel de México, S.A. de C.V., Miguel de Cervantes Saavedra No. 193, Pisos 10 y 11, Col. Granada, Alcaldía Miguel Hidalgo, C.P. 11520, México, Ciudad de México. R.F.C. MME-920701-NB3. Tels: 59-05-51-00 Ext. 5206 ó 01-800-463-59-89. Mattel Chile, S.A., Avenida América Vespucio 501-B, Quilicura, Santiago, Tel: 1230-020-6213. Servicio al consumidor Venezuela: Tel: 0-800-100-9123. Mattel Argentina, S.A., Av. Libertador 1000, Piso 11 - Oficinas 109 y 111, Vicente López - Prov. Buenos Aires. Tel: 0800-666-3373. Mattel Colombia, S.A., Calle 123#7-07 P5, Bogotá. Tel: 01800-710-2069. Mattel Perú, S.A., Av. Juan de Arona # 151, Centro Empresarial Juan de Arona, Torre C, Piso 7, Oficina 704, San Isidro, Lima 27, Perú. RUC: 20425853865. Reg. Importador: 02350-12-JUE-DIGESA. Tel: 0800-54744. E-mail Latinoamérica: servicio.clientes@mattel.com. Mattel do Brasil Ltda. - CNPJ: 54.558.002/0001-20 - Rua Verbo Divino, 1488 - 2º - Andar - 04719-904 - Chácara Santo Antônio - São Paulo - SP - Brasil. Serviço de Atendimento ao Consumidor: fone 0800 575 0780. E-mail: sac.matteldobrazil@mattel.com

**DISCOVER A WORLD OF UNLIMITED STORYTELLING
WITH BARBIE® BUILDING SETS**

**DÉCOUVREZ UN MONDE DE POSSIBILITÉS INFINIES
AVEC LES COFFRETS DE CONSTRUCTION BARBIE**



**DESCUBRE UN MUNDO DE AVENTURAS SIN FIN CON LOS CONJUNTOS DE CONSTRUCCIÓN DE BARBIE
DESCOBRIR UM MUNDO DE HISTÓRIAS ILIMITADAS COM OS CONJUNTOS DE CONSTRUÇÃO DA BARBIE
MIT DEN BARBIE BAUSET EINE WELT VOLLER UNBEGRENZTEM SPIELSPAß ENTDECKEN
ОТКРОЙТЕ ДЛЯ СЕБЯ МИР БЕЗГРАНИЧНЫХ ИСТОРИЙ ВМЕСТЕ С НАБОРАМИ КОНСТРУКТОРА БАРЕБИ**

BARBIE® and associated trademarks and trade dress are owned by, and used under license from Mattel.
©2022 Mattel.

©2022 MEGA Brands &™ MEGA Brands.
Printed in China / Imprimé en Chine AD-HPN80-01A

© D781,964, D797,203, D841,101

Mattel Canada Inc. Mississauga, Ontario L5R 3W2.
MADE IN CHINA. FABRIQUÉ EN CHINE. FABRICADO NA CHINA. HECHO EN CHINA.
ИЗГОТОВЛЕНО В КИТАЕ. ÇIN'DE ÜRETİLMİŞTİR. صنع في الصين



HPN78



HPN79



HPN80

Set(s) sold separately and subject to availability. / Ensemble(s) vendu(s) séparément. Certains produits peuvent ne pas être commercialisés. / Se vende(n) por separado y está(n) sujeto(s) a disponibilidad. / Conjunto(s) vendido(s) em separado e sujeito(s) à disponibilidade. / Set in vendita separatamente, secondo disponibilità. / Das/Die Set(s) sind separat erhältlich. / Zestaw(y) sprzedawany(e) oddzielnie w zależności od dostępności. / Set(s) apart verkrijgbaar en afhankelijk van beschikbaarheid. / Набор(-ы) продаются отдельно, при наличии. / Sæt sælges separat og så længe lager haves. / Seten säljs separat så länge lagret räcker. / Tettet/settene selges separat så langt lageret rekker. / Pakkaus/pakkaukset myydään erikseen, saatavuus voi vaihdella. / Το(α) σετ πωλούνται ξεχωριστά και ανάλογα με τη διαθεσιμότητα. / Setler ayrı olarak satılır ve stoklarla sınırlıdır. / Set (sety) se prodává (prodávaji) samostatně dle aktuální nabídky. / Súprava/-y sa predáva(jú) samostatne a podľa dostupnosti. / A készlet(ek) külön kapható(k), az elérhetőség változhat. / セット商品は別売りになります。在庫状況は別途ご確認をお願いします。

تباع المجموعة أو المجموعات على حدة وتخضع لتوافرها.
每套单独发售，按供货情况决定。

